



ISO 9001:2008



Digital Temperature Controller

CONOTEC CO., LTD.

www.conotec.co.kr

Instruction Manual CNT-P400/410



CNT-P400 CNT-P410

- * PID Temperature Controller
- * 1 output available for current/SSR (cycle/phase control/common on/off)
- * Relay output : A P400 and three P410s
- * Hardware select function enables user to select from alarm output, current transmission and controlled output
- * Various sensor inputs are available, such as thermoresistor, thermocouple, NTC sensor, voltage (mV, Volt), current (4 ~ 20mA), etc.
- * RS485 communications (MODBUS-RTU) are supported (P410 model)

※ Thank you for purchasing Conotec's product. This instruction manual is distributed in order to prevent product damage and malfunctions caused by carelessness and to inform you how to use it correctly. Please keep it well for reference in case you face any question during product use.

You can also download its English version from our homepage.

1 Safety Precautions

Please read the precautions carefully before use for correct usage.

※ The specifications, outer dimensions, etc. listed in this manual are subject to change without prior notice for product performance improvement.

Warning (警告)

- Since this product has not been intended to be a safety device, please be sure to attach double safety devices to it in case it is used to control devices that might cause serious casualties or extensive damage to important peripheral equipments or properties.
- Please do not connect lines, check, or repair the product while it is in power-on state.
- Before connecting the power, please be sure to check its terminal number.
- The product shall not be disassembled, modified, upgraded or repaired in any case.

Caution (注意)

- Please familiarize yourself with the operating instructions, safety regulations and warnings before installing this device and use it only within the prescribed specifications or the relevant capacity.
- Do not wire or install the device around motors or solenoids with large induction load.
- When extending the sensors, use the same wire and do not make it longer than necessary.
- Do not use parts that generate arc when opening or closing it on or nearby the same power source.
- Keep its power line away from high-voltage lines and do not install it in places heavily contaminated with water, oil or dust.
- Do not install it in locations exposed to direct sunlight or rain.
- Do not install it in locations subject to strong magnetism, noise, vibration or shock.
- Keep it away from locations directly producing strong alkaline or acidic materials.
- When installing in the kitchen, do not spray water directly for cleaning purpose.
- Do not install it in locations where the temperature/humidity exceeds the rated value.
- Use it taking care not to break or scratch the sensor lines.
- Keep the sensor lines away from signal lines, power source, power lines and load lines, and use independent piping for it.
- Please note that arbitrary disassembly and modification of this product makes follow-up service invalid.
- The indication on the terminal wiring diagram is a safety statement for warning or caution.
- Do not use it near the equipments generating strong high-frequency noise (such as high-frequency welding machine, high-frequency sewing machine, high-frequency radio and large capacity SCR controller).
- Using the product in other ways than those specified by the manufacturer may result in personal injury or property damage.
- It is not a toy. So, please place it beyond children's reach.
- Its installation shall be done exclusively by relevant specialists or qualified personnel.
- We do not take any responsibility for damages caused by the failure to comply with the contents specified in the above warning or caution statement or negligence on the part of consumer.

Danger (危険)

- Caution. Risk from electrical shock
- 1. Electrical shock - Do not touch the AC terminal while its power is on. You may get an electric shock.
- 2. Be sure to shut off the input power when checking the input power.

This manual contains instructions for two products.

P400 : Basic product

- Hardware output: 1 current and SSR output (OUT1), 1 relay output (OUT2)
- Control function: 1 heating control / 1 cooling control / 1 alarm output / 1 current transmission output

P410 : Optional product

- Hardware output: 1 current and SSR output (OUT1), 3 relay outputs (OUT2, OUT3 and OUT4)
- Control function: 1 heating control / 1 cooling control / 2 alarm outputs / 1 current transmission output

2 Product Specifications

Input power	100~240VAC 50/60Hz	Display accuracy	±1% rdg ±1 digit
Display method	7 segments 0.51 Inch 4 Digit 2 Line		

Model	OUT1	OUT2
P400 model	Current output and transmission / SSR output (general, cycle and phase control) - Current: Resistance load within 500 ohms, SSR: Within 11VDC ±2V 20mA	1a 250VAC 2A relay
P410 model	Current output and transmission / SSR output (general, cycle and phase control) - Current: Resistance load within 500 ohms, SSR: Within 11VDC ±2V 20mA	OUT2 / OUT3 / OUT4: 1a 250VAC 2A relay

Sensor specifications	Type	Sensor name	Temperature range	Type	Sensor name	Temperature range
	Resistance Temperature Detector (RTD)	DPT100ohms	-199.9 ~ 400.0°C	Thermistor	NTC10K (low temp.)	-55.0 ~ 99.9°C
JPT100ohms		-199.9 ~ 400.0°C	NTC10K (high temp.)		-20.0 ~ 250.0 °C	
Thermocouple (TC)	K	-50 ~ 1200°C	Voltage	mV	0.0 ~ 100.0mV	
	N	-50 ~ 1200 °C		0~5V	0.00 ~ 5.00V	
	T	-50 ~ 400°C	1~5V	1.00 ~ 5.00V		
	J	-50 ~ 1200°C	0~10V	0.00 ~ 10.00V		
	E	-50 ~ 1000°C	0~20mA	0.00 ~ 20.00mA		
Current				4~20mA	4.00 ~ 20.00mA	

Communication specification (P410 model) RS485, MODBUS RTU, Data 8 bit, Parity None, Stop bit 1

Usage environment (P410 model) 0~55 , 35-80% Rh (No formation of ice or condensation)
Allowed voltage fluctuation range 90% to 110% of the power-supply voltage

Classification	Selectable hardware	Selectable output type
Control output 2 (cooling control)	OUT1 SSR on/off, SSR general PID, SSR cycle PID, SSR phase PID, current PID OUT2 Relay on/off, relay PID	
Alarm output	OUT2 High temperature alarm, low temperature alarm, high temperature & low temperature alarm sensor error, loop error (output error)	
Transmission output	OUT1 Current temperature transmission, set temperature transmission, control variable transmission	
P400 model	Control output 1 (heating control)	OUT1 SSR on/off, SSR general PID, SSR cycle PID, SSR phase PID, current PID
	Control output 2 (cooling control)	OUT2 Relay on/off, relay PID
	Alarm output 1	OUT2 High temperature alarm, low temperature alarm, high temperature & low temperature alarm sensor error, loop error (output error)
	Alarm output 2	OUT3 High temperature alarm, low temperature alarm, high temperature & low temperature alarm sensor error, loop error (output error)
P410 model	Alarm output 1	OUT2 High temperature alarm, low temperature alarm, high temperature & low temperature alarm sensor error, loop error (output error)
	Alarm output 2	OUT3 High temperature alarm, low temperature alarm, high temperature & low temperature alarm sensor error, loop error (output error)
Transmission output	OUT1 Current temperature transmission, set temperature transmission, control variable transmission	

Power failure compensation About 10 years (nonvolatile semiconductor memory type)

Caution

- * When using cycle PID control and phase PID control with SSR, be sure to use products with SSR providing NonZero-Crossing and with their reaction speed within 1ms.

3 Names of Front Operation and Display Segments

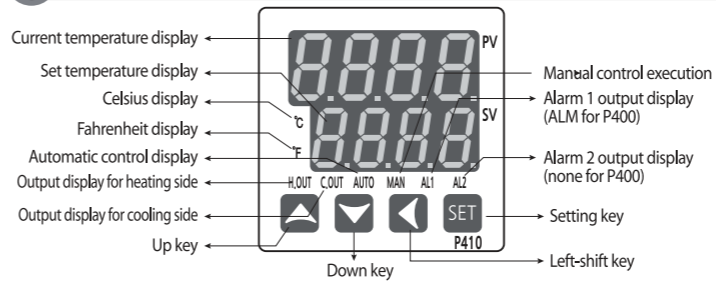

Unique function display

- AUTO** Automatic control indicator light. Light on : currently in automatic control, Flickering : currently in automatic tuning
- H.OUT C.OUT** In case of PID control, the flickering depends on the amount of control variable.
- Start/stop switch key** Press the key in the operation screen to switch to either start or stop mode. Stop mode display **STOP**
- Alarm release key** In case of alarm generation, press the key in the operation screen to disable the alarm output.
- Auto/manual switch key** Press the key in the operation screen to switch to either auto or manual mode. **AUTO** Auto display **MAN** Manual display
- Auto tuning key** Press both keys for more than 3 seconds during operation to enable starting or stopping the auto tuning process.
- Setting value initialization** Press both keys for more than 3 seconds during operation to reset the system (all setting values are initialized)

4 Product's Outer Standard and Panel Processing Dimension

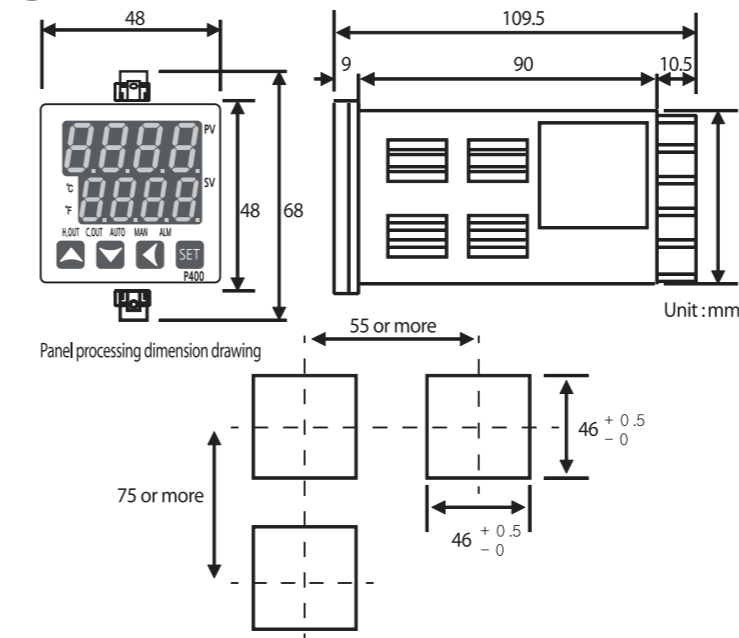

5 Terminal Wiring Diagram

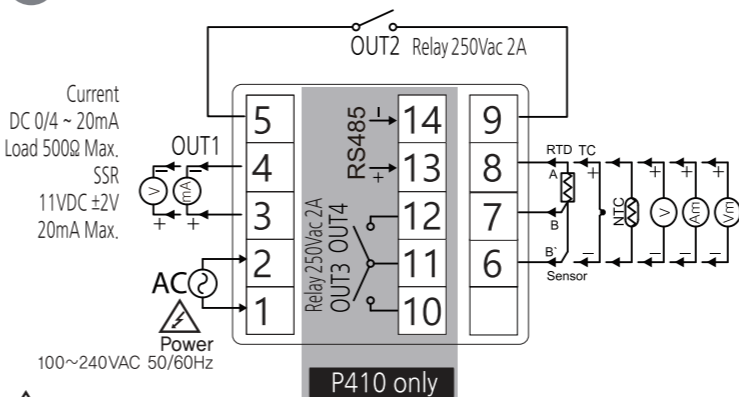

Warning

- * For wiring or replacing, please work with the power off.
- * Relay connection capacity is less than 250VAC 2A. Please be careful as using a load exceeding the contact capacity may cause contact fusion, connection failure, relay damage, etc.

Caution

- * When using cycle PID control and phase PID control with SSR, be sure to use products with SSR providing NonZero-Crossing and with their reaction speed within 1ms.
- * Since many menus are initialized with sensor change, be sure to recheck the settings of all menus once again.

6 Power-on logo



7 How To Set Up the Program

Changing setting temperature and manual control variables

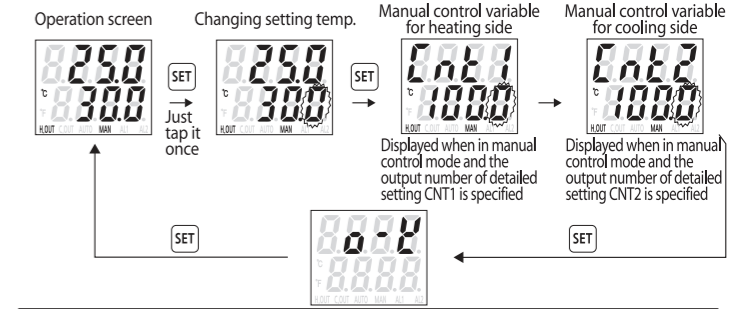

Changing automatic Control / Manual Control

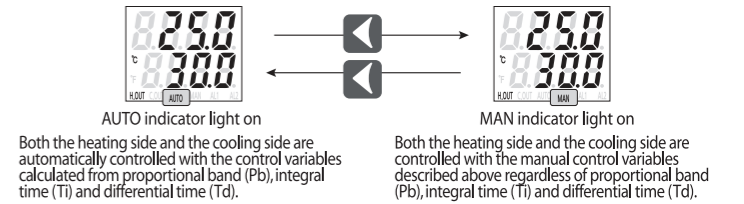

Auto tuning start / stop

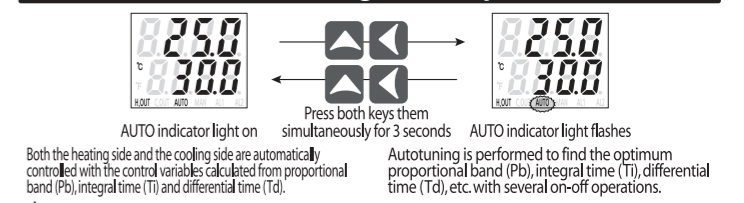

Caution

- * Some menus cannot be changed during auto tuning, and the **EUNE** characters are briefly displayed briefly to indicate that tuning is in progress.

Auto tuning

As a process to find the optimum coefficient, on/off tuning is completed 2 to 3 times near the set temperature. Auto tuning does not start in the sensor error state, and stops even when sensor error state occurs during tuning.

Initialization of setting

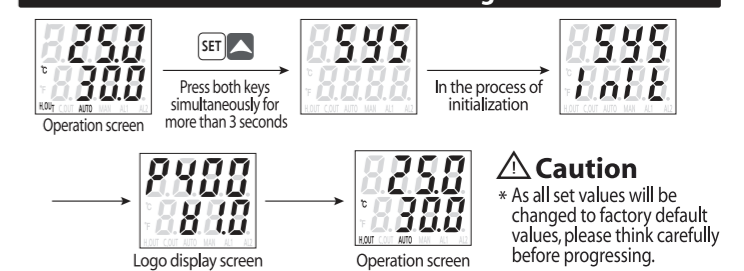

Error display

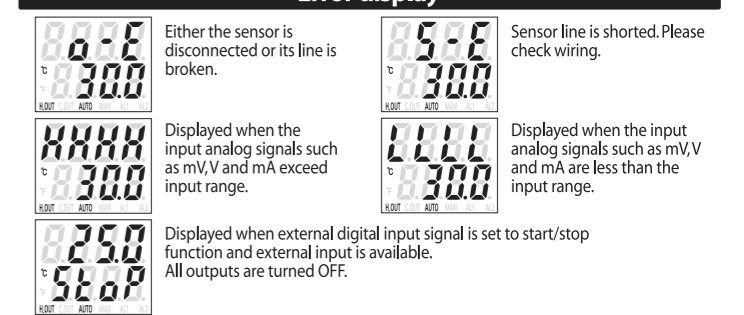

Detailed program settings Press **SET** key for more than 5 seconds in the operation screen to enter detailed setting menu. Press **SET** key for more than 3 seconds after adjusting all the setting values to save them and return to the operation screen. **SET** Enters setup menu, goes to setup menu **▲▼** Changing setting values **◀▶** Shifting setting position Shaded menus are displayed according to the selected function.

Settings on heating side (control output 1)

P400 Menu Order

P410 Menu Order

out.n Selecting output hardware on heating side (control output 1)
 out.1 Current or SSR output
 out.2 Relay
 out.3 Relay P410 model only
 out.4 Relay P410 model only
 no No selection

CSEL Selecting control method on heating side (control output 1)
 SPPd SSR on/off control Available when OUT1 is selected
 Snpd SSR on/off PID control Available when OUT1 is selected
 SPCd SSR cycle PID control Available when OUT1 is selected
 SPPd SSR phase PID control Available when OUT1 is selected
 Rpd Current PID control Available when OUT1 is selected
 rLnF Relay on/off control Available when OUT2, OUT3 or OUT4 is selected
 rLPd Relay on/off PID control Available when OUT2, OUT3 or OUT4 is selected

dIF Setting on/off deviation for heating side (control output 1)
 Displayed only when the control method is Snpd rLnF

dLE Setting output delay time for heating side (control output 1)
 Displayed only when the control method is Snpd rLnF

CPT Setting PID control period for heating side (control output 1)
 Displayed only when the control method is Snpd rLPd

Pb Setting PID proportional bandwidth for heating side (control output 1)
 Displayed only when the control method is Snpd SPCd

ti Setting PID integral time for heating side (control output 1)
 Displayed only when the control method is Snpd SPCd

td Setting PID differential time for heating side (control output 1)
 Displayed only when the control method is Snpd SPCd

rSt Steady state error correction for heating side (control output 1)
 Displayed only when the control method is Snpd SPCd

RL Setting peak current output for heating side (control output 1)
 Displayed only when the control method is Rpd

RLo Setting bottom current output for heating side (control output 1)
 Displayed only when the control method is Rpd

Settings for cooling side (control output 2)

out.n Selecting output hardware for cooling side (control output 2)
 out.1 Relay
 out.2 Relay P410 model only
 out.3 Relay P410 model only
 out.4 Relay P410 model only
 no No selection

CSEL Selecting control method for cooling side (control output 2)
 rLnF Relay on/off control Available when OUT2, OUT3 or OUT4 is selected
 rLPd Relay on/off PID control Available when OUT2, OUT3 or OUT4 is selected

dIF Setting on/off deviation for cooling side (control output 2)
 Displayed only when the control method is rLnF

dLE Setting output delay time for cooling side (control output 2)
 Displayed only when the control method is rLnF

CPT Setting PID control period for cooling side (control output 2)
 Displayed only when the control method is rLPd

Pb Setting PID proportional bandwidth for cooling side (control output 2)
 Displayed only when the control method is rLPd

ti Setting PID integral time for cooling side (control output 2)
 Displayed only when the control method is rLPd

td Setting PID differential time for cooling side (control output 2)
 Displayed only when the control method is rLPd

rSt Steady state error correction for cooling side (control output 2)
 Displayed only when the control method is rLPd

Alarm output 1 setting

out.n Alarm output 1 output hardware selection
 out.1 No selection
 out.2 Relay
 out.3 Relay P410 model only
 out.4 Relay P410 model only

ALYP Alarm output 1 alarm type selection
 ALH Higher-limit alarm
 ALL Lower-limit alarm
 ALHL Higher-/lower-limit alarm
 SENS Sensor error
 FALL Loop error (output error)

ALHD Alarm output 1 alarm hold selection
 YES Using hold
 no No usage

PASS Alarm output 1 initial alarm pass selection
 YES Using pass
 no No usage

HP Alarm output 1 higher-limit alarm temperature setting
 Displayed only when the alarm type is ALH ALHL

LP Alarm output 1 lower-limit alarm temperature setting
 Displayed only when the alarm type is ALL ALHL

ARdF Alarm output 1 alarm release deviation temperature setting
 Displayed only when the alarm type is ALH ALL ALHL

noDir Alarm output 1 output direction setting
 nL Normal/Close output
 nO Normal/Open output

Alarm output 2 setting

out.n Alarm output 2 output hardware selection
 out.1 No selection
 out.2 Relay
 out.3 Relay P410 model only
 out.4 Relay P410 model only

ALYP Alarm output 2 alarm type selection
 ALH Higher-limit alarm
 ALL Lower-limit alarm
 ALHL Higher-/lower-limit alarm
 SENS Sensor error
 FALL Loop error (output error)

ALHD Alarm output 2 alarm hold selection
 YES Using hold
 no No usage

PASS Alarm output 2 initial alarm pass selection
 YES Using pass
 no No usage

HP Alarm output 2 higher-limit alarm temperature setting
 Displayed only when the alarm type is ALH ALHL

LP Alarm output 2 lower-limit alarm temperature setting
 Displayed only when the alarm type is ALL ALHL

ARdF Alarm output 2 alarm release deviation temperature setting
 Displayed only when the alarm type is ALH ALL ALHL

noDir Alarm output 2 output direction setting
 nL Normal/Close output
 nO Normal/Open output

Current output 1 setting

out.n Current output 1 output hardware selection
 out.1 No selection
 out.2 Current output

ALrS Current output 1 current output type selection
 PUL Current temp.
 SBL Setting temp.
 CntL Control variable

L20 Current output 1. Temperature at 20 mA
L4 Current output 1. Temperature at 4 mA

System setting

in Input and sensor type setting
 dPL1 German Industrial Standard PT100
 dPL2 Japan Industrial Standard PT100
 KTC K type thermocouple
 NTC N type thermocouple
 T type thermocouple
 J type thermocouple
 E type thermocouple
 NTC10K Low temperature NTC10K high temperature
 0-100mV voltage
 0-5V voltage
 0-10V voltage
 0-20mA current
 4-20mA current

PI PID operation type
 FAST Fast operation
 STAN Standard operation

NO NO overshooting tuning deviation temperature setting

Addr RS485 communication address

bPS RS485 communication address

Cor Sensor calibration setting

Unit Temperature display unit
 no No unit
 cF Celsius display
 fF Fahrenheit display

SCL Whether analog scale function is used

RI Higher-limit value of analog signal input
RI Lower-limit value of analog signal input
RSCL Higher-limit value of analog signal scale
LSCL Lower-limit value of analog signal scale
dot Decimal point position of Analog signal scale
bRnd Band setting
rnp Lamp change temperature setting
rnpL Lamp change time setting
LPCr Loop error detection temperature setting
LPLC Loop error detection time setting

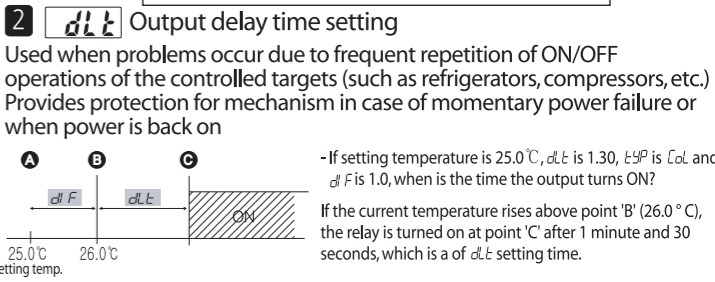
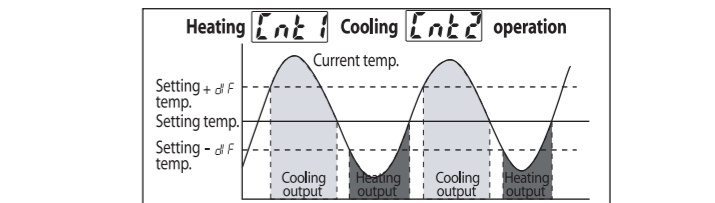
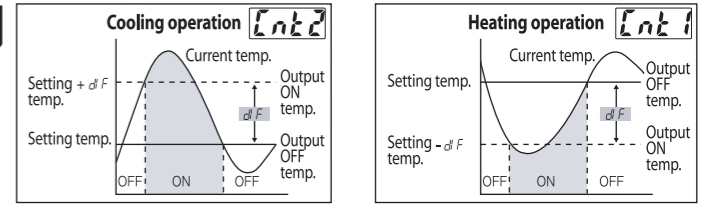

2 dLE Output delay time setting
 Used when problems occur due to frequent repetition of ON/OFF operations of the controlled targets (such as refrigerators, compressors, etc.). Provides protection for mechanism in case of momentary power failure or when power is back on

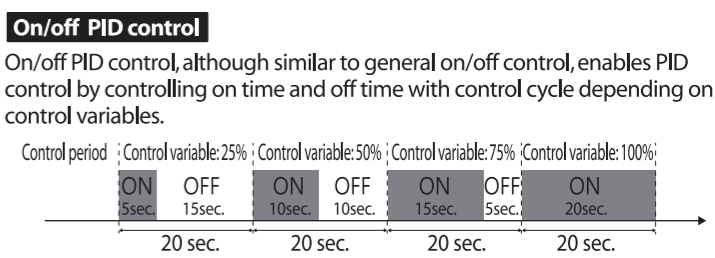

When OUT1 is selected as the hardware for heating and cooling outputs, on/off PID control is enabled using SSR. When OUT2, OUT3 or OUT4 is selected (only OUT2 is available for P400), PID control using relay is enabled.

If OUT1 is selected for control method selection menu **CSEL**, it must be set to **Snpd**. If OUT2, OUT3 or OUT4 is selected, it must be set to **rLPd**. For PID control using the relay, the minimum on/off time varies depending on the control period (CPT).

- When the CPT control period is less than 5 seconds: 0.3 seconds, less than 10 seconds: 0.5 seconds, more than 10 seconds: 1 seconds
- The minimum on/off time for PID control using SSR is 0.05 second in any case.

Caution If the control period is too short for PID control using relays, the relay's contact life may be reduced due to frequent ON/OFF operations.

Caution For on/off PID control using SSR, only SSR with ZeroCrossing enables noise reduction.

3 CPT Control period setting
 Performing PID control using relay or SSR output repeats ON outputs and OFF operations for a certain time within the set time period. Here, the set time period is called the control period.

4 Pb Proportional bandwidth
 If the current temperature falls within the proportional bandwidth, the control variable P changes.

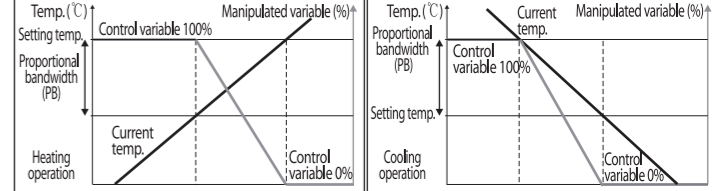

5 ti Integral time
 Integral time refers to the time required to obtain the same manipulated variable as in the proportional operation with the integral operation alone. While the proportional operation alone does not allow the current temperature to reach the target value and a temperature deviation occurs, the integral operation integrates the magnitude of the deviation to add it to the manipulated variable, allowing the current temperature to reach the target value.

Caution * Since some menus initialize the values of other menus depending on the set values, it is recommended to set the following menus first. When the below menus are changed, be sure to check the values of other previously set menus first.

* The menu selects an output hardware among OUT1/OUT2/OUT3/OUT4, and can initialize the control method of heating/cooling output depending on the selected value. Tuning stops if auto tuning is in progress.

* The menu changes the control method of heating/cooling output, and changes the hardware setting in accordance with the selected control method. And tuning stops if auto tuning is in progress.

* The menu changes input sensor. The following menus are initialized.

Setting temperature	Scale function	Higher limit of scale input	Lower limit of scale input	Higher limit of scale display	Lower limit of scale display	Scale decimal point	ON/OFF output deviation
Pb	rSt	ARdF	Cor	bRnd	rnp	rnpL	noSF
Proportional band	Steady state error correction	Alarm output deviation	Temperature sensor calibration	Band setting	Lamp change temperature	Loop error detection temperature	NO overshoot tuning deviation

Character indicator character table

0	1	2	3	4	5	6	7	8	9	A	B	C	D	E	F	G		
H	I	J	K	L	M	N	O	P	Q	R	S	T	U	V	W	X	Y	Z

For P410 model

Heating side (control output 1) On/off control PID control	OUT1 Current output and SSR drive available	OUT2 Relay	OUT3 Relay	OUT4 Relay
Cooling side (control output 2) On/off control PID control	OUT1 Current output and SSR drive available	OUT2 Relay	OUT3 Relay	OUT4 Relay

8 Control output description (heating output and cooling output)
 The output of this product is configured to select hardware by function. The control output can be selected among OUT1, OUT2, OUT3 and OUT4.

For P400 model

Heating side (control output 1) On/off control PID control	OUT1 Current output and SSR drive available	OUT2 Relay
Cooling side (control output 2) On/off control PID control	OUT1 Current output and SSR drive available	OUT2 Relay

On/off control
 When OUT1 is selected as the hardware for heating and cooling outputs, on/off control is enabled using SSR. When OUT2, OUT3 or OUT4 is selected (**only OUT2 is available for P400**), on/off control using relay is enabled. If OUT1 is selected for control method selection menu **CSEL**, it must be set to **Snpd**. If OUT2, OUT3 or OUT4 is selected, it must be set to **rLnF**.

1 dIF On/off deviation temperature setting
 If the relay output is repeatedly turned ON and OFF too often, the output contact will be damaged quickly or hunting (oscillation or chattering) will occur due to the external noise. To prevent the phenomenon, this function sets a constant interval between ON and OFF output operation, protecting the device's contact point.

- * If the integral time is too short: Regular vibration may occur
- * If the integral time is too long: It becomes difficult or time-consuming to reach the target temperature
- * If the integral time is 0, integral operation is not enabled.

6 t_d Differential time

Differential time refers to the time required to obtain the same manipulated variable as in the proportional operation with differential operation alone when the deviation shows constant change. The differential operation monitors the deviation for the disturbance occurring rapidly and, if the difference from the previous deviation is large, increases the manipulated variable significantly to enable quick response to the disturbance.

- * If the differential time is too short: Response to disturbance becomes slow
- * If the differential time is too long: Regular vibration may occur
- * If the differential time is 0, differential operation does not occur.

7 r_{SE} Steady state error correction

Applied when only the proportional operation (P) is used. The proportional operation alone does not enable you to reach the target temperature and results in a steady state error. This menu can be used to correct deviations.

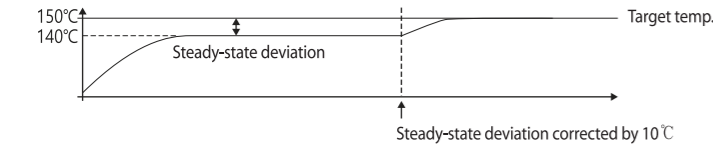

SSR cycle PID control

SSR cycle PID control uses ZeroCrossing type SSR and adjusts the number of On/Off in one unit of AC power depending on the control variable before outputting it.

ZeroCrossing type AC power control reduces more opening/closing noise than the phase control method, and its unfixed control period and variable change at the optimum ratio enables more precise control. For cycle control, OUT1 should be selected for hardware for heating output and cooling output.

For cyclic PID control using SSR, SSR is available regardless of NonZeroCrossing or ZeroCrossing. (Response speed is within 1 ms)

Caution Since the ZeroCrossing of the load power should be detected in the product, the product's operation power and load must share the common power when NonZeroCrossing type SSR is applied.

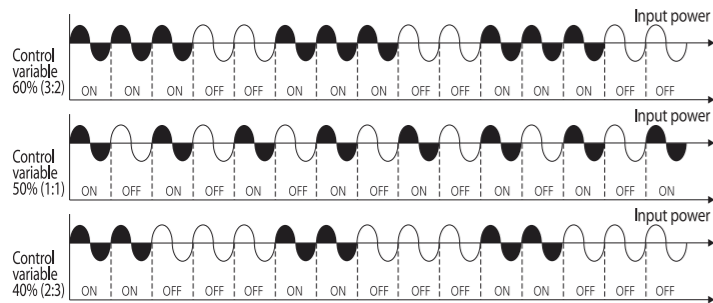

SSR phase PID control

SSR phase PID control uses NonZeroCrossing type SSR, controls the phase within half cycle of AC power depending on the control variable and can control load power continuously.

Generally, power regulator can be used for phase control. However, as it is rather expensive and bulky, using low cost SSR is more efficient.

For phase control, OUT1 should be selected for hardware for heating output and cooling output.

Control method selection menu $CSEL$ must be set to $SPPd$.

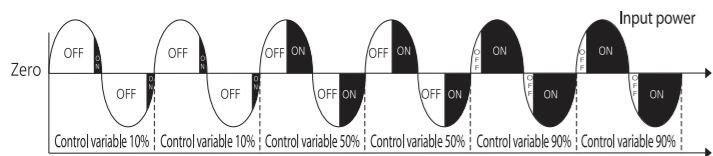

Caution Phase PID control using SSR requires SSR capable of NonZeroCrossing to be used (reaction speed should be within 1 ms).

Caution Since the ZeroCrossing of the load power should be detected in the product, the product's operation power and load must share the common power.

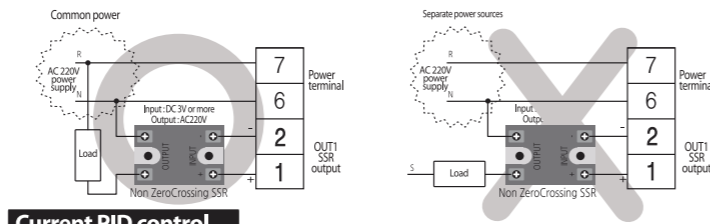

Current PID control

Current PID control effectively stabilizes the current temperature to the target temperature by adjusting the current output from 4 mA to 20 mA depending on the control variable. The output current is controlled with a continuous analog output. For current PID control, hardwares for heating output and cooling output should be selected as OUT1.

Control method selection menu $CSEL$ must be set to RPd .

Caution When using current output, the load resistance should be less than 500 ohms.

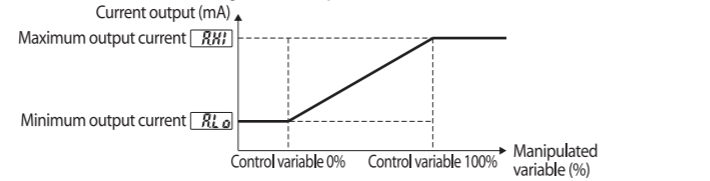

8 RHI Setting peak current output

The current output value when performing current PID control and the manipulated variable is 100%.

Ex) If $A.HI = 15.0mA$ and the manipulated variable is 100%, the current output is 15.0 mA.

RLO Setting bottom current output

The current output value when performing current PID control and the manipulated variable is 0%.

Ex) If $A.LO = 5.0mA$ and the manipulated variable is 0%, the current output is 5.0 mA.

PID operation type

9 $PIdt$ Setting PID operation type

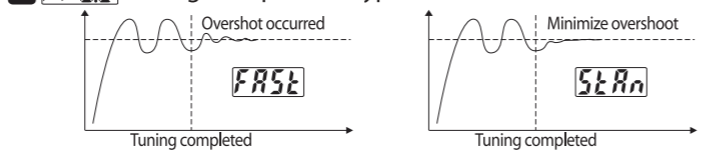

In FAST mode, the target temperature is reached faster even if there is some overshoot. In STANDARD mode, the target temperature is reached while minimizing overshoot.

Setting PID tuning temperature

10 $noSF$ NO overshoot tuning deviation temperature setting

For tuning that does not allow current temperature to exceed set temperature during auto-tuning operation, the tuning is performed at a position that is away from the set temperature by NO overshoot tuning deviation temperature, and then made to reach the set temperature. (It is not applicable when using both heating and cooling simultaneously.)

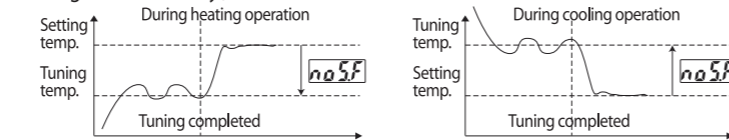

Band function

11 $bRNd$ Setting Band function

When using both heating output and cooling output, the area can be specified between heating control and cooling control. If the setting value is 0, it is not applicable. If it is set to '+', an area where the control variable becomes 0% is generated on both the heating side and the cooling side. If it is set to '-', an area where the heating side control and the cooling side control overlap.

Heating: PID control, Cooling: PID control

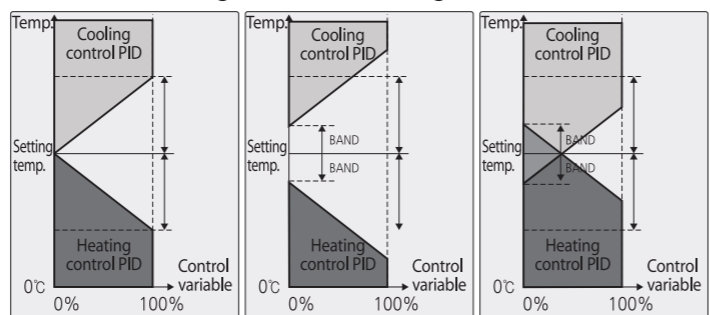

If $bRNd$ setting is 0,

If $bRNd$ setting is '+', an area with zero control variable based on the set temperature is generated.

If $bRNd$ setting is '-', an area where the heating and cooling controls overlap based on the set temperature is generated.

Heating: PID control, Cooling: On/off control

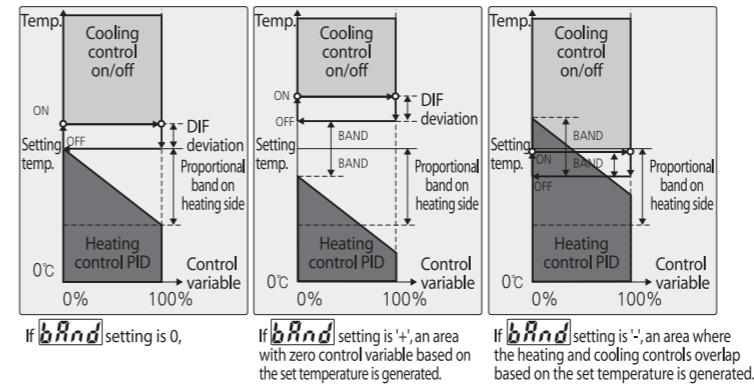

If $bRNd$ setting is 0,

If $bRNd$ setting is '+', an area with zero control variable based on the set temperature is generated.

If $bRNd$ setting is '-', an area where the heating and cooling controls overlap based on the set temperature is generated.

Heating: On/off control, Cooling: PID control

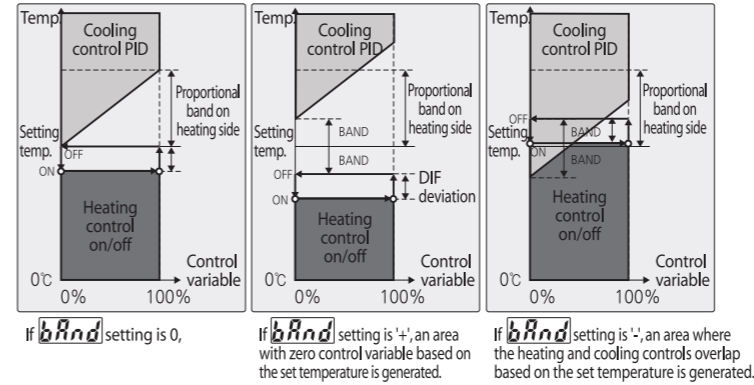

If $bRNd$ setting is 0,

If $bRNd$ setting is '+', an area with zero control variable based on the set temperature is generated.

If $bRNd$ setting is '-', an area where the heating and cooling controls overlap based on the set temperature is generated.

Heating: On/off control, Cooling: On/off control

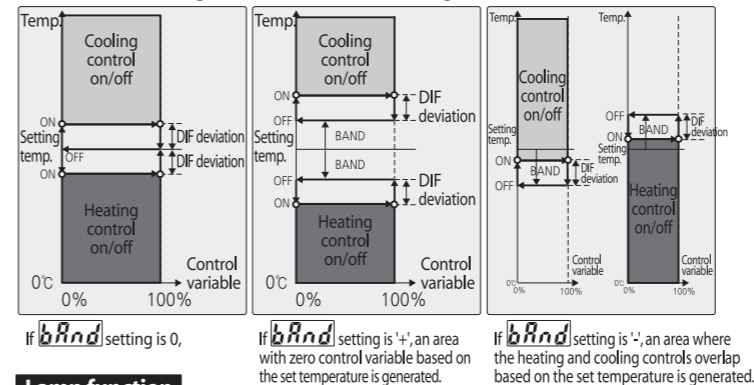

If $bRNd$ setting is 0,

If $bRNd$ setting is '+', an area with zero control variable based on the set temperature is generated.

If $bRNd$ setting is '-', an area where the heating and cooling controls overlap based on the set temperature is generated.

Lamp function

The lamp function is a mean to prevent sudden temperature shift when the setting value (SV) is changed. That is why it is mainly used in the field where control targets may face problems.

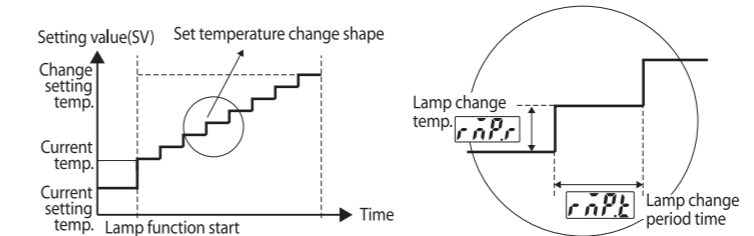

12 $rnPp$ Lamp change temperature

The temperature value that adjusts the setting temperature whenever the lamp changes after starting to function.

Ex) Lamp change temperature: 5°C, Current setting temperature: 10°C, Target setting temperature: 50°C, Lamp change time: 1 minute
=> Increase the setting temperature by 5°C every minute and stop the lamp at 50°C.

13 $rnPt$ Lamp change time

This menu changes the lamp change temperature every set time after the lamp function is started. When the set value is 0, the lamp function does not work.

5 Alarm output description (Alarm output 1, Alarm output 2)

The output of this product is configured to select hardware by function.

P400 model OUT2 can be selected for Alarm output.



P410 model The alarm output can be selected among OUT2, OUT3 or OUT4.

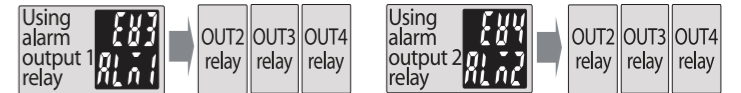

Higher-limit alarm

14 Available when $ALYP$ is selected from the ALM menu.

An alarm is generated when the current temperature becomes higher than the set higher-limit alarm temperature. To release the generated alarm, the temperature should be lowered by the ADF setting value. The higher-limit alarm temperature shall be set in the HP_r menu.

Lower-limit alarm

15 Available when $ALYP$ is selected from the ALL menu.

An alarm is generated when the current temperature becomes lower than the set lower-limit alarm temperature. To release the generated alarm, the temperature should be increased by the ADF setting value. The lower-limit alarm temperature shall be set in the LP_r menu.

Higher-/lower-limit alarm

16 Available when $ALYP$ is selected from the $ALHL$ menu.

An alarm is generated when the current temperature becomes higher than the set higher-limit alarm temperature or lower than the set lower-limit alarm temperature. Both higher-limit and lower-limit alarms can be used simultaneously.

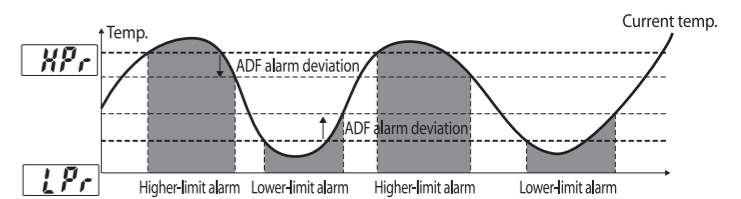

Sensor error alarm

$a-E$ Either the sensor is disconnected or its line is broken.

$s-E$ Sensor line is shorted. Please check wiring.

$i-E$ Displayed when an abnormality occurs in the cold junction compensation sensor for the thermocouple sensor. Please contact the manufacturer for the after-sales service.

$HHHH$ Displayed when the input analog signals such as mV, V and mA exceed the input range.

$LLLL$ Displayed when the input analog signals such as mV, V and mA are less than the input range.

Loop disconnection alarm

If the control variable of the heating or cooling device is 0% or 100%, there ought to be a temperature change. However, problematic output device wouldn't produce temperature change and should be regarded to be failing.

17 $rPLr$ Loop error detection temperature

Sets the temperature width that should be changed within the detection time when the loop error detection function starts.

Ex) Loop error detection time: 5 minutes, Loop error detection temperature: 2°C, => If the control variable is 0% or 100% and temperature change is less than 2 degrees within 5 minutes, it is treated as an alarm occurrence.

18 $rPLt$ Loop error detection time

Sets the detection time for loop error. If the control variable is 0% or 100% and temperature change is no more than the detection temperature set within the time, it is treated as an alarm occurrence. If the setting value is 0, the loop error detection function does not work.

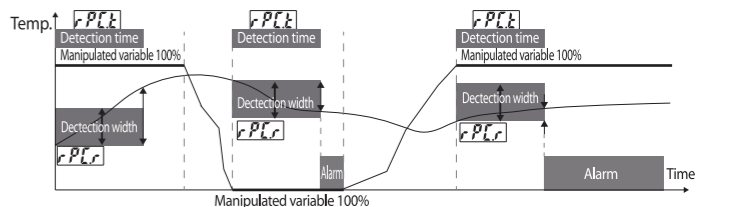

No alarm is generated because the temperature change is higher than the detection width during the monitoring time while the manipulated value is 100%.

Alarm is generated because the temperature change is lower than the detection width during the monitoring time while the manipulated value is 0%.

Alarm is generated because the temperature change is lower than the detection width during the monitoring time while the manipulated value is 100%.

Alarm hold function

19 When **PHLD** is set to

- no** If the generated alarm is released, corresponding alarm output is turned OFF.
- YES** Even if the generated alarm is released, corresponding alarm output continues to be turned ON.

=> The power should be turned back on to release the alarm. If the external digital input is set to the alarm release function, alarm can be released when the corresponding key is operated



Alarm pass function

21 When **PASS** is set to

- no** The corresponding alarm output is turned ON even when the initial alarm is generated after power on.
- YES** The corresponding alarm output is not turned ON when the initial alarm is generated after power on.

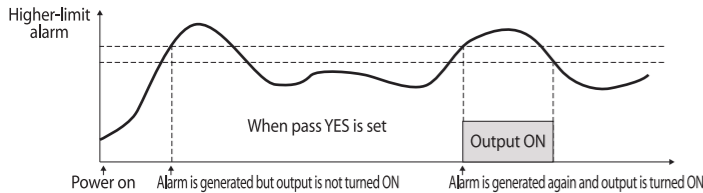

Output direction setting

22 When **NOOL** is set to

- no** : Output is normally turned OFF, and turned ON when alarm is generated
- nl** : Output is normally turned ON, and turned OFF when alarm is generated

10 Current transmission description

The output of this product is configured to select hardware by function. For the current transmission output, OUT1 can be used.

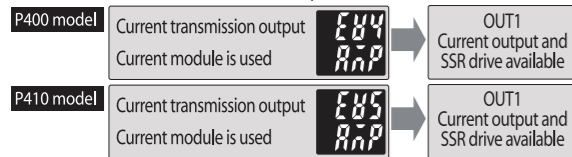

Current temperature transmission

23 Setting **RTS** to **PHL** enables transmission of current temperature to the current.

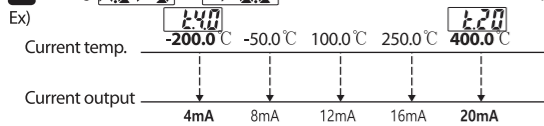

Setting temperature transmission

24 Setting **RTS** to **SHL** enables transmission of current temperature to the current. When the lamp function is in use, the setting temperature being changed is transmitted.

Control variable transmission

25 Setting **RTS** to **CTL** enables transmission of the control variable.

11 Analog scale function

Analog scale function displays the analog signal input value after expanding or reducing it to the specified maximum or minimum value. It can be used when the voltages



26 Setting **SCALE** to **YES** enables analog scale function.

27 **RI nH** is a menu for setting the maximum value of the input analog signal.

28 **RI nL** is a menu for setting the minimum value of the input analog signal.

29 **HSCL** is the expanded or reduced value displayed when the analog signal input is **RI nH**.

30 **LSCL** is the expanded or reduced value displayed when the analog signal input is **RI nL**.

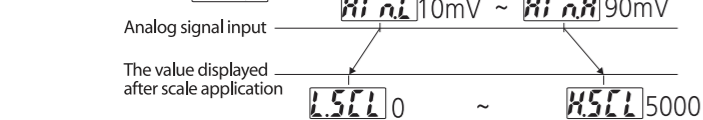

31 **dot** is a menu to expand or reduce the scale of the analog input signal for display and then set the decimal point position of the displayed value.

12 Input sensor and others

32 **in** menu is used to select input sensor.

33 **Cor** menu is used to calibrate the values displayed by the input sensor if they are different compared to the ones by other precision instruments.

Ex) Current temperature: 20°C, Temperature by precise instrument: 22°C => COR correction value: If 2°C is entered, the current temperature is displayed as 22°C.

34 **Unit** menu is used to change the display unit of the input sensor. It can be used only when the input sensor is designated as the temperature sensor, Celsius or Fahrenheit is available for selection.

13 Communication description

- * RS485 MODBUS RTU type protocol is built in.
- * Asynchronous 2-wire half-duplex communication method
- * Communication distance : Within 1.2 Km
- * Communication speed : 1200 / 2400 / 4800 / 9600 / 19200 Bps
- * Start bit : 1 bit, Stop bit : 1 bit, Parity bit : None, Data bit : 8 bit

35 **Addr** menu is for setting RS485 communication address.

36 **bPS** menu is for setting RS485 communication address.

< Func 0x02: Read Discrete Inputs >

Simple information such as controller status can be received in bit form.

NO	Address	Description	Range	Unit	Factory default value
100001	0000	Sensor open error	0 / 1		
100002	0001	Sensor short error	0 / 1		
100003	0002	Cold junction compensation sensor error	0 / 1		
100004	0003	Auto tuning	0: Tuning x / 1: Tuning ongoing		
100005	0004	On/off output for heating side	0: Off / 1: On		
100006	0005	On/off output for cooling side	0: Off / 1: O		
100007	0006	Alarm output 1	0: Off / 1: O		
100008	0007	Alarm output 2 P410 model only	0: Off / 1: O		
100009	0008	Temp. unit Celsius	0: No unit / 1: Celsius		
100010	0009	Temp. unit Fahrenheit	0: No unit / 1: Fahrenheit		
100011	000A	Start / Stop	0: Stop / 1: Start		
100012	000B	Alarm release input	0: No input / 1: Release input		
100013	000C	Auto mode	0: No auto / 1: Auto mode		
100014	000D	Manual mode	0: No manual / 1: Manual mode		
100015	000E	Not used			
100016	000F	Not used			
100017	0010	Not used			
100018	0011	Not used			
100019	0012	Whether heating control is used	0: Not used / 1: Used		
100020	0013	Whether cooling control is used	0: Not used / 1: used		
100021	0014	Whether alarm output 1 is used	0: Not used / 1: used		
100022	0015	Alarm output 2 P410 model only	0: Not used / 1: used		
100023	0016	Whether current output is used	0: Not used / 1: used		
100024	0017	Not used			
100025	0018	Analog scale	100025 100025 00: 0000 01: 000.0		
100026	0019	Decimal point display position	0019100019 10: 00.00 11: 0.000		

< Func 0x04: Read Inputs Registers >

Simple information such as current temperature, sensor status and output status can be received.

NO	Address	Description	Range	Unit	Factory default value
300001	0000	Current temperature	In case of sensor error: -5000 0 DPT100 1 JPT100 2 TC.K 3 TC.N 4 TC.T 5 TC.J 6 TC.E 7 NTC low temp. 8 NTC high temp. 9 0~100mV 10 0~5V 11 1~5V 12 0~10V 13 0~20mA 14 4~20mA	°C	
300002	0001	Input sensor type			
300003	0002	Current setting temperature	The lamp temperature when the lamp function is operating	°C	
300004	0003	Control variable for heating side	0.0 ~ 100.0		
300005	0004	Control variable for cooling side	0.0 ~ 100.0		
300006	0005	System status bit (100016~100017)	Func 0x02: Read Discrete Inputs content		
300007	0006	System status bit (100026~100017)	Func 0x02: Read Discrete Inputs content		
300008	0007	Model name	0x5037('P', '7')		
300009	0008	Model name	0x3030('0', '0')		
300010	0009	Model name	0x0000		

300006(0005) System status bit

300007(0006) System status bit

< Func 0x03: Read Hoding Registers > < Func 0x06: Write Single Registers >

The controller settings menu can be read. The controller setting menu can be changed one item at a time.

< Func 0x10: Write Multiple Registers >

The controller setting menu can be changed several items at a time.

NO	Address	Description	Range	Unit	Factory default value
400001	0000	Sensor information	Refer to the Func 0x04 Inputs Registers '300002' item		0: DPT100
400002	0001	PID, Operation type	0: Standard operation, 1: High speed operation		0: Standard operation
400003	0002	NO overshoot tuning deviation setting	0.0~30.0°C	°C	0.0°C
400004	0003	Not used			
400005	0004	Not used			
400006	0005	Not used			
400007	0006	Not used			
400008	0007	Manual control variable for heating side	Manual mode control variable for heating side	%	0
400009	0008	Manual control variable for cooling side	Manual mode control variable for cooling side	%	0
400010	0009	Heating control output number	OUT1		OUT1
400011	000A	Cooling control output number	P400 model OUT2 P410 model OUT2 / OUT3 / OUT4		OUT2
400012	000B	Alarm output 1 output number	P400 model OUT2 P410 model OUT2 / OUT3 / OUT4		P400 model NO P410 model OUT3

NO	Address	Description	Range	Unit	Factory default value
400013	000C	Alarm output 2 P410 model only	OUT2 / OUT3 / OUT4		OUT4
400014	000D	Current transmission output number	OUT1		NO
400015	000E	Not used			
400016	000F	Control type for heating side	0: SSR on/off control 1: SSR on/off PID control 2: SSR cycle PID control 3: SSR phase PID control 4: Current PID control 5: Relay on/off control 6: Relay on/off PID control		1: SSR on/off PID control
400017	0010	Control type for cooling side	5: Relay on/off control 6: Relay on/off PID control		6: Relay on/off PID control
400018	0011	On/off deviation for heating side	0.1 ~ 20.0	°C	1.0
400019	0012	On/off deviation for cooling side	0.1 ~ 20.0	°C	1.0
400020	0013	Output delay time for heating side	0 ~ 1999	Sec.	0
400021	0014	Output delay time for cooling side	0 ~ 1999	Sec.	0
400022	0015	Control period for Heating side	0 ~ 120	Sec.	20
400023	0016	Control period for cooling side	0 ~ 120	Sec.	20
400024	0017	Proportional band for heating side	0 ~ 30.0	°C	10.0
400025	0018	Proportional band for cooling side	0 ~ 30.0	°C	10.0
400026	0019	Integral time for heating side	0 ~ 9999	Sec.	0
400027	001A	Integral time for cooling side	0 ~ 9999	Sec.	0
400028	001B	Differential time for heating side	0 ~ 9999	Sec.	0
400029	001C	Differential time for cooling side	0 ~ 9999	Sec.	0
400030	001D	Steady state error correction for heating side	-30.0 ~ 30.0	°C	0
400031	001E	Steady state error correction for cooling side	-30.0 ~ 30.0	°C	0
400032	001F	Current output peak value for heating side	0 ~ 20.0	mA	20.0
400033	0020	Not used			
400034	0021	Current output bottom value for heating side	0 ~ 20.0	mA	4
400035	0022	Not used			
400036	0023	Information output 1 alarm type	0: Higher-limit alarm output 1: Lower-limit alarm output 2: Higher-lower-limit alarm output 3: Sensor error output 4: Loop error output		Higher-limit alarm
400037	0024	Alarm output 2 alarm type P410 model only			Lower-limit alarm
400038	0025	Alarm output 1 alarm hold	0: No hold, 1: Hold function used		0: No hold
400039	0026	Alarm output 2 alarm hold P410 model only	0: No hold, 1: Hold function used		0: No hold
400040	0027	Alarm output 1 initial alarm pass	0: No pass, 1: Initial alarm pass		0: No pass
400041	0028	Alarm output 2 initial alarm pass P410 model only	0: No pass, 1: Initial alarm pass		0: No pass
400042	0029	Alarm output 1 higher-limit alarm	Refer to 400004 multi SV	°C	Multi SV peak value
400043	002A	Alarm output 2 higher-limit alarm P410 model only	Refer to 400004 multi SV	°C	Multi SV peak value
400044	002B	Alarm output 1 lower-limit alarm	Refer to 400004 multi SV	°C	Multi SV bottom value
400045	002C	Alarm output 2 lower-limit alarm P410 model only	Refer to 400004 multi SV	°C	Multi SV bottom value
400046	002D	Alarm output 1 alarm deviation	0.1 ~ 20.0	°C	0.1
400047	002E	Alarm output 2 alarm deviation P410 model only	0.1 ~ 20.0	°C	0.1
400048	002F	Alarm output 1 output direction	0: Normal Open, 1: Normal Close	°C	1: NormalOpen
400049	0030	Alarm output 2 output direction P410 model only	0: Normal Open, 1: Normal Close	°C	1: NormalOpen
400050	0031	Transmission output transmission type	0: Current temperature transmission 1: Setting temperature transmission 2: Control variable transmission		0: Current temperature transmission
400051	0032	Not used			
400052	0033	Transmission output 20mA data	Refer to 400004 multi SV	°C	Multi SV peak value
400053	0034	Not used			
400054	0035	Transmission output 40mA data	Refer to 400004 multi SV	°C	Multi SV bottom value
400055	0036	Not used			
400056	0037	RS485 communication address	1 ~ 99		1
400057	0038	RS485 communication speed	1200/2400/4800/9600/19200		9600
400058	0039	Sensor input calibration	-20.0 ~ 20.0		0.0
400059	003A	Not used			
400060	003B	Not used			
400061	003C	Not used			
400062	003D	Not used			
400063	003E	Not used			
400064	003F	Not used			
400065	0040	Temperature display unit	0: No unit, 1: Celsius, 2: Fahrenheit		1: Celsius
400066	0041	Analog scale used	0: Not used, 1: Used		0: Not used
400067	0042	Analog input's higher limit	Refer to 400002 multi SV		Multi SV peak value
400068	0043	Analog input's lower limit	Refer to 400002 multi SV		Multi SV bottom value
400069	0044	Analog scale's higher limit	-1999 ~ 9999		2000
400070	0045	Analog scale's lower limit	-1999 ~ 9999		400
400071	0046	Analog scale decimation point display position	0: 0.000 1: 0.000 2: 0.00 3: 0.000		0: 0.000
400072	0047	Band setting	-20.0 ~ 20.0	°C	0
400073	0048	Lamp value	0 ~ 20.0		0
400074	0049	Lamp time	0 ~ 5999	sec.	
400075	004A	Loop disconnection check value	0 ~ 20.0	°C	0
400076	004B	Loop disconnection monitoring time	0 ~ 1000	sec.	0

14 Etc.

Sensor extension

- * Resistance Temperature Detector's DPT100, JPT100 Sensors: All three wires must have the same material and thickness.
- * Thermocouple's K, N, T, J and E sensors: It should be extended using the same wire or dedicated compensation wire as the sensor wires.
- * NTC sensor: It should be extended using 2P shield wires.

Warning

Soldering is recommended for the extension part and care should be taken as the poorly processed extension part may cause sensor malfunction due to invasive moisture. Our company does not take responsibility for product malfunction caused by sensor extension. If possible, please make sure that the sensor is custom manufactured in desired length from the beginning.

Memory error display

Err 1 Displayed when abnormal data is written to the non-volatile memory in the product or when the data is compromised due to severe external noise. Pressing the # key when this display appears changes the setting value to the factory default value.

■ This controller is equipped with a supplementary countermeasure against external noise. However, incoming noise of around 2 KV may damage its internal parts.

■ Warranty: 1 year from the date of purchase

■ The above product specifications are subject to change without prior notice to improve the product performance.

■ Please be sure to be well-acquainted with the contents specified in the handling precautions for the above product.

■ The English manual can be downloaded from our homepage.

■ Address: Conotec Building, 26, Yunsan-ro, Geumjeong-gu, Busan 46269, Republic of Korea
Factory: The 1st basement floor / Managing sales team: 2F / Research Institute and AS: 3F