

60 mm Diameter Incremental Rotary Encoders

E60 Series

INSTRUCTION MANUAL

TCD210023AA

Autonics

Thank you for choosing our Autonics product.

Read and understand the instruction manual and manual thoroughly before using the product.

For your safety, read and follow the below safety considerations before using.

For your safety, read and follow the considerations written in the instruction manual, other manuals and Autonics website.

Keep this instruction manual in a place where you can find easily.

The specifications, dimensions, etc. are subject to change without notice for product improvement. Some models may be discontinued without notice.

Follow Autonics website for the latest information.

Safety Considerations

- Observe all 'Safety Considerations' for safe and proper operation to avoid hazards.
- ⚠ symbol indicates caution due to special circumstances in which hazards may occur.

⚠ Warning Failure to follow instructions may result in serious injury or death.

01. Fail-safe device must be installed when using the unit with machinery that may cause serious injury or substantial economic loss. (e.g. nuclear power control, medical equipment, ships, vehicles, railways, aircraft, combustion apparatus, safety equipment, crime / disaster prevention devices, etc.)

Failure to follow this instruction may result in personal injury, economic loss or fire.

02. Do not use the unit in the place where flammable / explosive / corrosive gas, high humidity, direct sunlight, radiant heat, vibration, impact or salinity may be present.

Failure to follow this instruction may result in explosion or fire.

03. Install on a device panel to use.

Failure to follow this instruction may result in fire.

04. Do not connect, repair, or inspect the unit while connected to a power source.

Failure to follow this instruction may result in fire.

05. Check 'Connections' before wiring.

Failure to follow this instruction may result in fire.

06. Do not disassemble or modify the unit.

Failure to follow this instruction may result in fire.

⚠ Caution Failure to follow instructions may result in injury or product damage.

01. Use the unit within the rated specifications.

Failure to follow this instruction may result in fire or product damage.

02. Do not short the load.

Failure to follow this instruction may result in fire.

03. Do not use the unit near the place where there is the equipment which generates strong magnetic force or high frequency noise and strong alkaline, strong acidic exists.

Failure to follow this instruction may result in product damage.

Cautions during Use

- Follow instructions in 'Cautions during Use'. Otherwise, it may cause unexpected accidents.
- 5 VDC≐, 12 - 24 VDC≐ power supply should be insulated and limited voltage / current or Class 2, SELV power supply device.
- For using the unit with the equipment which generates noise (switching regulator, inverter, servo motor, etc.), ground the shield wire to the F.G. terminal.
- Ground the shield wire to the F.G. terminal.
- When supplying power with SMPS, ground the F.G. terminal and connect the noise canceling capacitor between the 0 V and F.G. terminals.
- Wire as short as possible and keep away from high voltage lines or power lines, to prevent inductive noise.
- For Line driver unit, use the twisted pair wire which is attached seal and use the receiver for RS-422A communication.
- Check the wire type and response frequency when extending wire because of distortion of waveform or residual voltage increment etc. by line resistance or capacity between lines.
- This unit may be used in the following environments.
 - Indoors (in the environment condition rated in 'Specifications')
 - Altitude max. 2,000 m
 - Pollution degree 2
 - Installation category II

Cautions during Installation

- Install the unit correctly with the usage environment, location, and the designated specifications.
- When fixing the product with a wrench, tighten under 0.15 N m.
- Do not apply tensile strength over 30 N to the cable.

Ordering Information

This is only for reference, the actual product does not support all combinations. For selecting the specified model, follow the Autonics website.

E60 H 20 - ① - ② - ③ - ④ - ⑤

① Resolution

Number: Refer to resolution in 'Specifications'

② Output phase

3: A, B, Z
6: A, \bar{A} , B, \bar{B} , Z, \bar{Z}

③ Control output

T: Totem pole output
N: NPN open collector output
V: Voltage output
L: Line driver output

④ Power supply

5: 5 VDC≐ ± 5%
24: 12 - 24 VDC≐ ± 5%

⑤ Connection

No mark: Radial cable type
C: Radial cable connector type

Product Components

- Product (+ bracket)
- Instruction manual
- Bolt × 4

Sold Separately

- Connector cable: CID6S-□, CID9S-□

Connections

- Unused wires must be insulated.
- The metal case and shield cable of encoders must be grounded (F.G.).
- F.G. (Frame Ground) must be grounded separately.

■ Totem pole / NPN open collector / Voltage output

Pin	Color	Function	Pin	Color	Function
1	Black	OUT A	4	Brown	+V
2	White	OUT B	5	Blue	GND
3	Orange	OUT Z	6	Shield	F.G.

• M17 6-pin layout

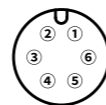

■ Line driver output

Pin	Color	Function	Pin	Color	Function
1	Black	OUT A	5	White	OUT B
2	Red	OUT \bar{A}	6	Gray	OUT \bar{B}
3	Brown	+V	7	Orange	OUT Z
4	Blue	GND	8	Yellow	OUT \bar{Z}
—	—	—	9	Shield	F.G.

• M17 9-pin layout

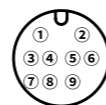

Inner Circuit

- Output circuits are identical for all output phase.

■ Totem pole output

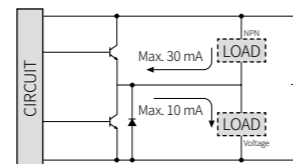

■ NPN open collector output

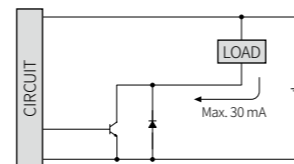

■ Voltage output

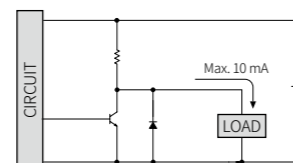

■ Line driver output

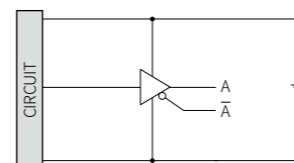

Output Waveform

- The rotation direction is based on facing the shaft, and it is clockwise (CW) when rotating to the right.
- Phase difference between A and B: $\frac{T}{4} \pm \frac{T}{8}$ (T = 1 cycle of A)

■ Totem pole / NPN open collector / Voltage output

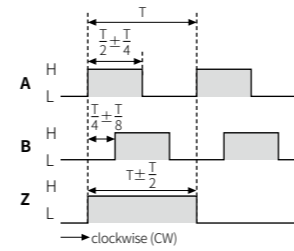

■ Line driver output

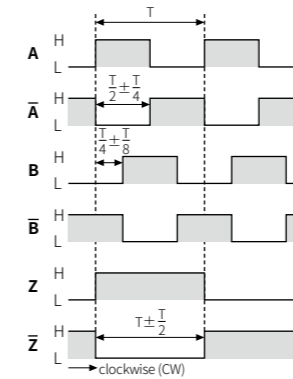

Specifications

Model	E60H20-□-3-T-□-□	E60H20-□-3-N-□-□	E60H20-□-3-V-□-□	E60H20-□-6-L-□-□
Resolution	100 / 1,024 / 5,000 / 8,192 PPR model			
Control output	Totem pole output	NPN open collector output	Voltage output	Line driver output
Output phase	A, B, Z	A, B, Z	A, B, Z	A, \bar{A} , B, \bar{B} , Z, \bar{Z}
Inflow current	≤ 30 mA	≤ 30 mA	-	≤ 20 mA
Residual voltage	≤ 0.4 VDC≐	≤ 0.4 VDC≐	≤ 0.4 VDC≐	≤ 0.5 VDC≐
Outflow current	≤ 10 mA	-	≤ 10 mA	≤ -20 mA
Output voltage (5 VDC≐)	≥ (power supply -2.0) VDC≐	-	-	≥ 2.5 VDC≐
Output voltage (12 - 24 VDC≐)	≥ (power supply -3.0) VDC≐	-	-	≥ (power supply -3.0) VDC≐
Response speed ⁰¹⁾	≤ 1 μs			
Max. response frequency	300 kHz			
Max. allowable revolution ⁰²⁾	6,000 rpm			
Starting torque	≤ 0.0147 N m			
Inertia moment	≤ 110 g·cm ² (11 × 10 ⁻⁶ kg·m ²)			
Allowable shaft load	Radial: ≤ 5 kgf, Thrust: ≤ 2.5 kgf			
Unit weight (packaged)	≈ 300 g (≈ 397 g)			
Approval	CE EAC	CE EAC	CE EAC	EAC

01) Based on cable length: 2 m, I sink: 20 mA

02) Select resolution to satisfy Max. allowable revolution ≥ Max. response revolution
(max. response revolution (rpm) = $\frac{\text{max. response frequency}}{\text{resolution}} \times 60 \text{ sec}$)

Power supply	5 VDC≐ ± 5% (ripple P-P: ≤ 5%) / 12 - 24 VDC≐ ± 5% (ripple P-P: ≤ 5%) model
Current consumption	Totem pole, NPN open collector, Voltage output: ≤ 80 mA (no load) Line driver output: ≤ 50 mA (no load)
Insulation resistance	Between all terminals and case: ≥ 100 MΩ (500 VDC≐ megger)
Dielectric strength	Between all terminals and case: 750 VAC~ 50 / 60 Hz for 1 minute
Vibration	1 mm double amplitude at frequency 10 to 55 Hz (for 1 minute) in each X, Y, Z direction for 2 hours
Shock	≤ 100 G
Ambient temp.	-10 to 70 °C, storage: -25 to 85 °C (no freezing or condensation)
Ambient humi.	35 to 85%RH, storage: 35 to 90%RH (no freezing or condensation)
Protection rating	IP50 (IEC standard)
Connection	Radial cable type / Cable connector type model
Cable spec.	Ø 5 mm, 5-wire (line driver output: 8-wire), shield cable cable type: 2 m, cable connector type: 250 mm
Wire spec.	AWG24 (0.08 mm, 40-core), insulator diameter: Ø 1 mm
Connector spec.	Totem pole, NPN open collector, Voltage output: M17 6-pin socket type Line driver output: M17 9-pin socket type

Dimensions

- Unit: mm, For the detailed drawings, follow the Autonics website.
- Following items are based on cable type. Refer to 'Specifications' for detailed specifications of cable, wire and connector.

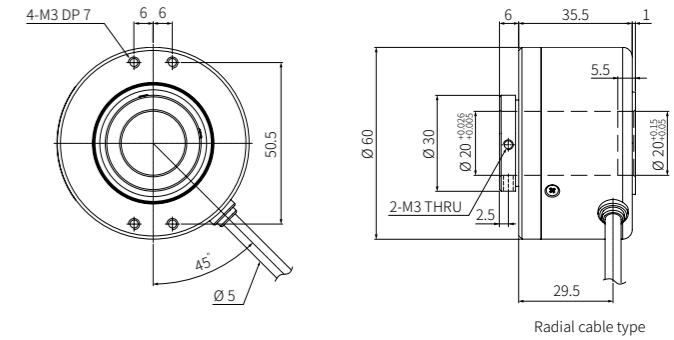

■ Bracket

