



Digital Temperature Controller

www.foxeng.co.kr



FOX-2003

Model	Sensor	Output	Temp. range	Function
FOX-2003 (for cooling)	NTC	Relay (3EA)	-55.0°C ~ +99.9°C	COMP control Defrost control FAN control

Thank you for selecting our products. Please read carefully this instruction to reduce any damages or operation mistakes.

Part name

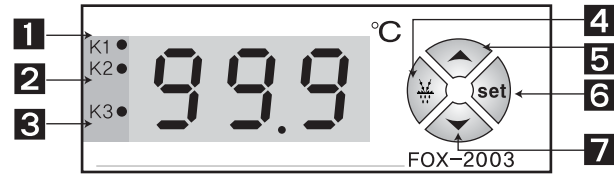

- 1 COMP output lamp
- 2 Defrost output lamp
- 3 FAN output lamp
- 4 Defrost switch
- 5 Setting up
- 6 Change function switch
- 7 Setting down

The function of each key.

- 1. : A key to change of the programs & setting temperature.
 - 2. : A key to change of the programs & setting values & temp.
 - 3. : A key for manual defrost
- Press the key for more than 3seconds to operate manual defrost.

Detailed manual

- E81** : To change the set values for the temperature output.
- E82** : To change the set values for the defrost output.
- E83** : To change the set values for the FAN output
- H5P** : Setting function of the highest limit of temperature range (Maximum set point allowed to the end user)
-Impossible to set up the set value more than H5P set value
ex) H5P = 25.0 setting impossible to raise the set value more
- L5P** : Setting function of the lowest limit of temperature range (Minimum set point allowed to the end user)
-Impossible to set up the set value less than L5P set value
ex) L5P = 10.0 setting impossible to lower the set value less
- d15** : Selection of the temperature deviation

P : + deviation (in the set point off)

ex) setting = 10.0 , d1 F : 5.0

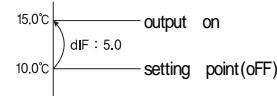

Pn : ± deviation

ex) setting = 10.0 d1 F : 5.0

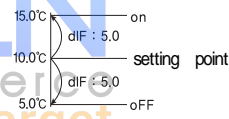

- d1 F** : Setting for temperature deviation

- In the ON/OFF control, it needs at regular interval between ON/OFF
- By operating the ON/OFF control frequently, the relay contact can be damaged quickly and it also occurs the hunting (oscillating) by virtue of external noise. You can make use of the temperature deviation to protect its relay or contact and so on.

ex The method of the temp. deviation when ON/OFF control

- present temp. > setting temp. + temperature deviation
} output ON
- present temp. < setting temp. - temperature deviation
} output OFF

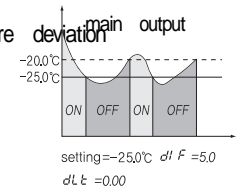

- dLt** : Delay time of the output

It is widely used as the followings
- in case of operating the ON/OFF control very often,
- to protect the operation machinery when re-input of the power momentary stoppage of power supply

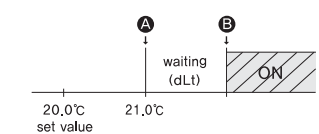

ex) if the set value is 1.30, from until time the relay is ON in the point after as delay as the setting time (1min.30sec. (flickering the output lamp during dLt

- Cor** : Correction of the present temperature.

- It is used for the correction of a discrepancy between set temperature and real temperature

ex) real temp. : 10.0 Cor : 0.0 -2.0 correction 10.0 display display : 12.0

- SEr** : setting for the COMP output while sensor's error continuous OFF

- LoC** : The lock function

- As a safety device, it is used in order not to change the set for the main use ON- setting for the lock function.
OFF- removal for the lock function

- d1P** : The selection of the COMP when defrosting

Con : COMP ON when defrosting
CoF : COMP OFF when defrosting

Setting temperature

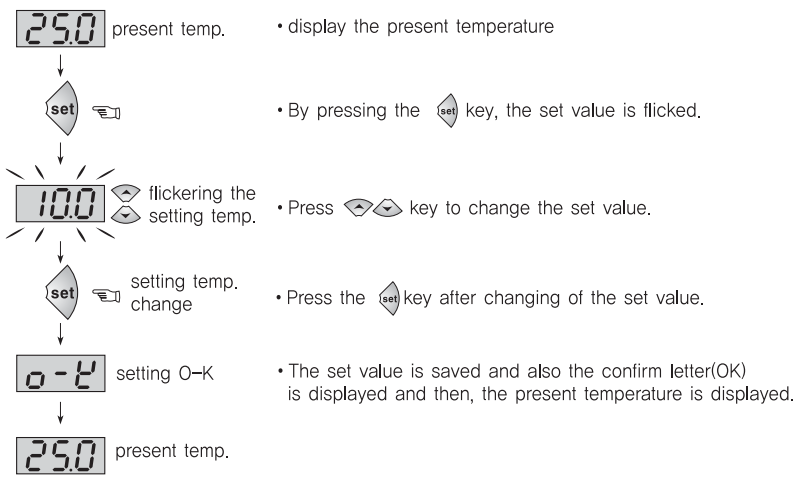

Setting for programs

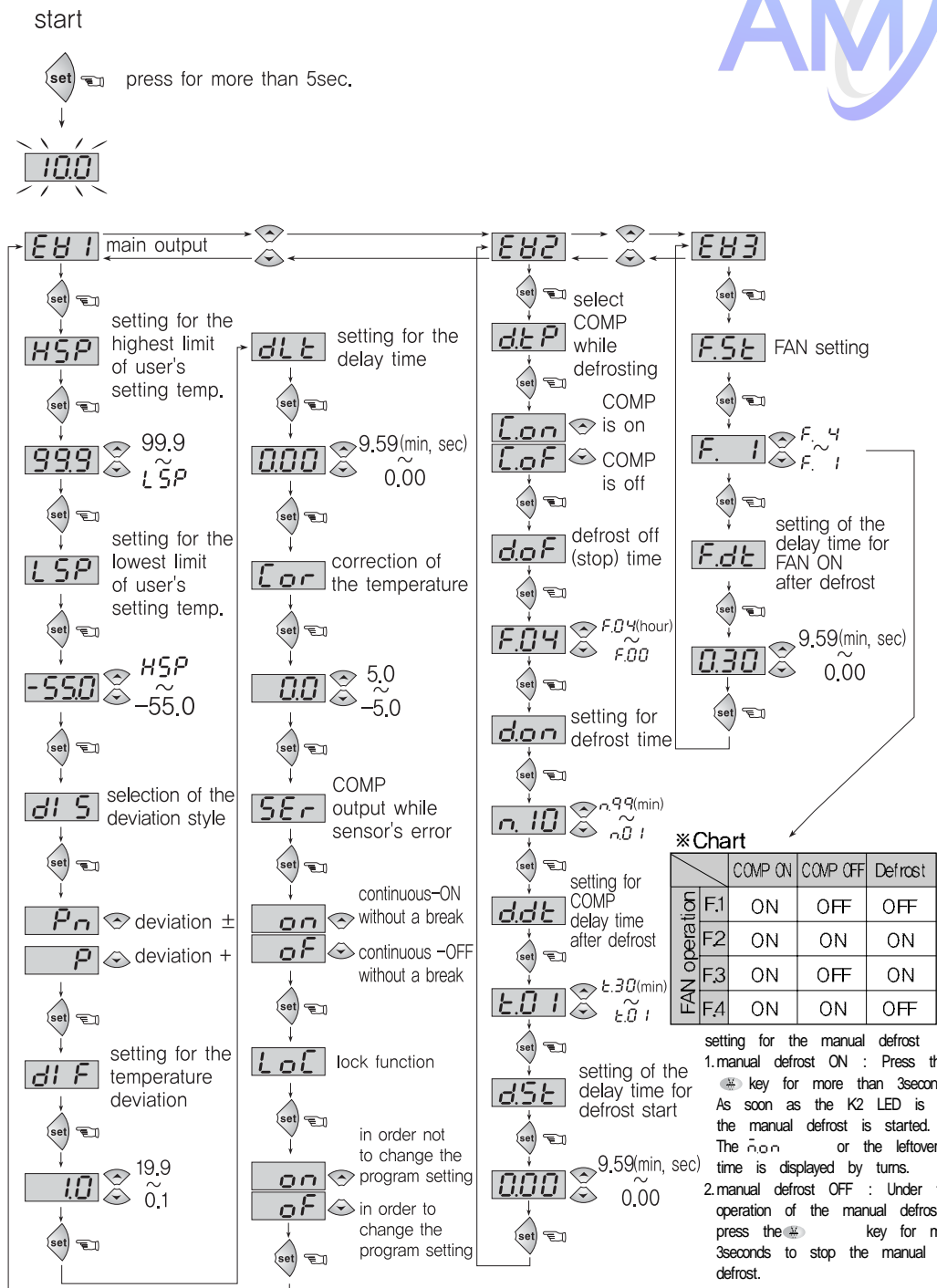

*Chart

	COMP ON	COMP OFF	Defrost
FAN operation	F.1 ON	OFF	OFF
	F.2 ON	ON	ON
	F.3 ON	OFF	ON
	F.4 ON	ON	OFF

setting for the manual defrost
1. manual defrost ON : Press the key for more than 3seconds. As soon as the K2 LED is flicked, the manual defrost is started. The don or the leftover defrost time is displayed by turns.
2. manual defrost OFF : Under the operation of the manual defrost, press the key for more than 3seconds to stop the manual defrost. Or be closed automatically after don time

To change it with program mode, press the key for more than 3seconds than the present temperature display mode. The set or programming mode is terminated, if you press the key for 2 seconds, parameters (set values) are saved after the display shows OK letter or return to present temperature display after 30 seconds.

13. **dof** : Defrost stop time
 - Setting range: 0.00 ~ 4.48 hour
 - Start the defrost if a cycle of the defrost
14. **dont** : Defrost time
 - setting range: 0.01 ~ 9.99 min
 - Operate the defrost while defrosting time.
 ex) dof : 4.04 (4hours), dont : 1.10 (10minute) setting

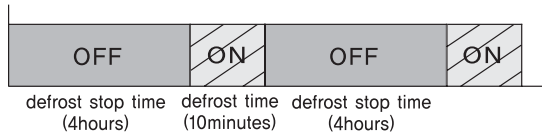

repeat the defrost operation for 10 minutes every 4 hours

15. **ddt** : Delay time of the COMP after defrost
 - setting range: 0.00 ~ 9.30 min
 - COMP output is ON : after as delay as the setting time after the defrost
 ex) ddt : 1.01 (1minute)

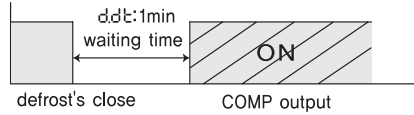

16. **d5t** : the delay time for defrost start
 - setting range 0.00 ~ 9.59 (minute, second)
 - COMP output is ON after as delay as the setting time before operating of the defrost
 ex) d5t : 0.10

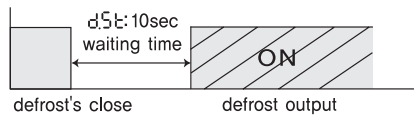

17. **Fst** : FAN setting F. (1 ~ 4) Pls refer to the chart in the eprogram mod
18. **Fdt** : Delay time of FAN ON after defrosting
 - setting range 0.00 ~ 9.59 (minute, second)
 ex) Fdt : 0.30(30seconds)

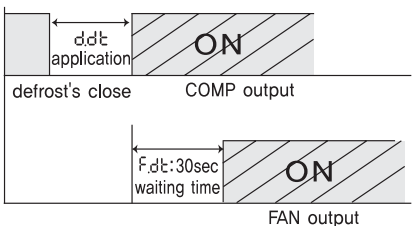

Temp. range & set value when deliver

Setting temp.	Function	Display	Range	Set values when deliver	Remarks
Program Setting	Setting temp.	LSP	-55.0~99.9	99.9	It is irrelevant to the relay output.
	Setting for the highest limit of use	LSP	-55.0~HSP	-55.0	It is irrelevant to the output relay.
	Selection of the deviation style	d15	P/Pn	P	Pn - deviation ± P - deviation +
	Temperature deviation	d1F	0.1~19.9	1.0	
	Delay time	d1t	0.00~9.59	0.00	(minute, second)
	Correction of temp.	Cor	-5.0~5.0	0.0	correct for an discrepancy between the display temp. and real temp.
	Sensor's error	SEr	on/off	oF	oF - COMP OFF
	Lock function	LoC	on/off	oF	oF - setting for the lock function oF - removal of the lock function however, except for the setting temperature value.
E81	Selection of the COMP while defrosting	d1P	CoN/CoF	CoF	CoN - COMP ON while defrosting CoF - COMP OFF while defrosting
	Defrost stop time	dof	F.00 ~ F.48	F.04	hour
	Defrost time	dont	n.01 ~ n.99	n.10	minute
	Delay time of the COMP after defrosting	ddt	t.00 ~ t.30	t.01	minute
	Delay time of operating for defrost	d5t	0.00 ~ 9.59	0.00	(minute, second)
E83	FAN setting	Fst	F.1 ~ F.4	F.1	Refer to the Chart
	Delay time of the FAN ON after defrosting	Fdt	0.00 ~ 9.59	0.30	(minute, second) Delay time of the COMP after defrosting

Relay junction

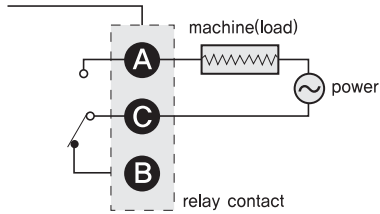

Connection

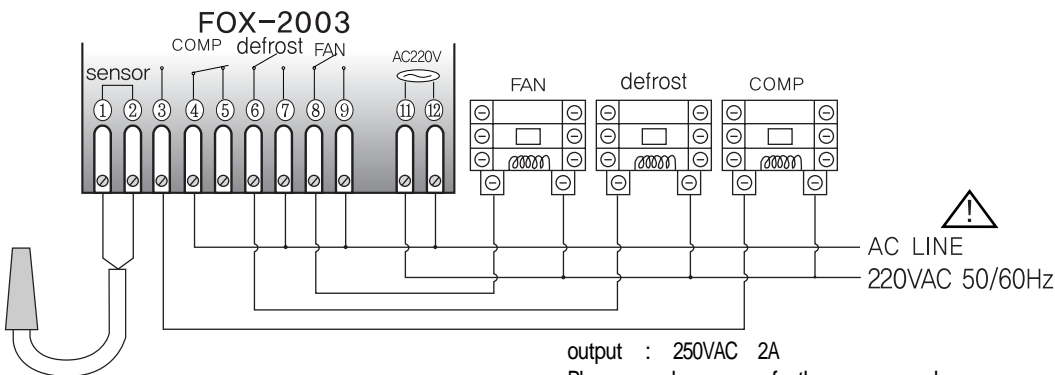

output : 250VAC 2A
 Please make use of the power relay or magnet switch.

Dimension

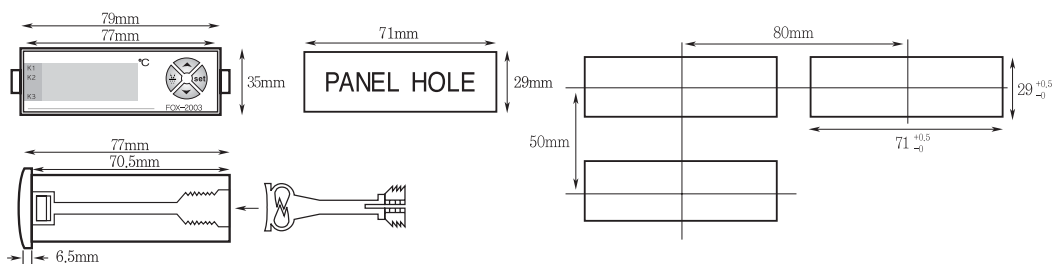

Safety and Hazard Instructions

Safety

Pls use this item after installing the duplex safety device in which is applied at dangerous factors such as serious human injury or serious damages of property & important machine because this item is not designed as safety device

Safety Instruction and Hazard Warnings

- Please read the operating manual through completely before putting the device into operation.
- We will not assume any responsibility for damage to assets or persons caused by improper handling or failure to observe the safety instructions or hazard warnings.
- For safety and licensing reasons, unauthorized conversion and/or modification of the device is not permitted.
- Do not exceed the maximum permissible current - in case of higher loads, use a contactor of adequate power. Make sure that the supplied voltage matches the values specified for the instrument.
- The device must be adequately protected from water and dust as per the application and must be accessible via the use of appropriate tools
- The device must not be exposed to extreme temperature, sunlight, strong vibrations or high levels of humidity.
- Operation or installation is not permitted under unfavorable ambient conditions such as wetness or excessive induction loads or solenoid and dust, combustible gases, vapors or solvents, especially high-frequency noise
- Operation or installation close to high-frequency fields such as welding devices, sewing machines, wireless transmitter, radio systems, SCR controller, etc
- Do not install the sensor cable nearby signal cable, power cable, load cable
- Please use the shield cable when the sensor cable's lengthen, however do not make it too much longer
- Please use the sensor cable without any cutting or flaw, blemish.
- The device is not a toy and should be kept away from children
- Installation work must only be carried out by suitably qualified personnel who are familiar with the hazards involved and with the relevant regulations.
- You shouldn't tinker with anything or the product may not be opened or disassembled unless you know what you're doing. Please ask us about this questioning

Danger

Attention ! Never work on electrical connections when the machine is switched on

Error message

- Er1 Memory error. Turn the power off and turn it on again
 If the error message persists, please request us A/S by return
- o-E Sensor error. The sensor is interrupted. Check the cable.
- S-E Sensor error. The sensor is short-circuited. Check the cable

The terms of guarantee : for one year from the date of purchase

Model & output spec.

	2001 (sensor : 1EA)	2001D (sensor : 1EA)	2001T (sensor : 1EA)	2001F (sensor : 1EA)	2000TT (sensor : 1EA)
temp. output	one-stage output	two-stage output	three stage output	four-stage output	control by the temperature & time (for greenhouses)
temp. output					temp. 1 temp. 2
alarm output	-	-	-	-	alarm 1 alarm 2
defrost output	-	-	-	-	-
FAN output	-	-	-	-	-

ex) application

Cooler turn off at 0.0 , turn on at 5.0 , defrost output every 4 hour, FAN turn on while COMP output, turn off while COMP OFF during defrost
 How to operate(setting for the temperature & programs) ?

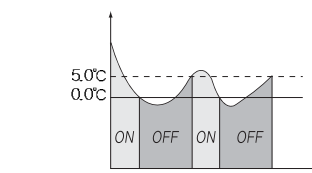

< setting temp. (see the setting temperature)
 setting : 0.0

< setting program (see the setting for program)

COMP setting
 d15 : P (one side deviation, turn off at setting point)
 d1F : 5.0 (due to the on/off's interval 5.0)

setting defrost

dof : 4.04 (defrost stop time : 4hours)
 dont : 1.10 (defrost time : 10minutes)

setting FAN

Fst : F.1
 COMP ON : FAN output on
 COMP OFF / while defrosting : FAN output off

*The product's specification can be changed without any notification to improve its quality.

H. Office : B-112, Techno plaza 681-11 Junpo 1 dong, Busanjin-ku, Busan, Korea
 Factory : B-408, 409, 410 Techno plaza 681-11 Junpo 1 dong, Busanjin-ku, Busan, Korea
 A/S TEL : +82-51-819-0426
 FAX : 82-51-819-4562
 E-mail : foxeng@foxeng.co.kr
 Homepage : http://www.foxeng.co.kr

*This device works proper operation with:
 Surrounding Temp. : 0°C~60°C
 Surrounding Humi. : below 80%RH
 Regular power : 220VAC ±10% 50/60Hz