



Operating Manual FOX-2003CC



1 Caution

Read the safety precautions carefully for correct usage.
 ※ The specifications, appearance, and measurements may change without advance notice for improvement of performance.

⚠ Danger

1. This product is not made as a safety device, so when it is used for a control of devices feared to cause casualties, damages to the peripheral devices or huge property loss, the double safety devices should be arranged before use.
2. Avoid connecting lines, checking and repairing the products while power is supplied.
3. Connect power after making sure the terminal number.
4. Never disassemble modify, improve or repair the product.

⚠ CAUTIONS

- Be well-informed of how to use, safety regulations, warnings, etc before installation of this device and apply it to the extent of the defined specifications and relevant capacity without fail.
- Avoid wiring or installation to a motor or solenoid with a large inductive load.
- Use a shielded cable for extension of the sensor and ensure not to make it longer than the necessity.
- Ensure not to use the parts generating arc when switching at the same power source or near to it.
- Keep the power cable away from a high-tention power line and ensure not to install it at a place with serious oil and dirt.
- Avoid strong magnetic field or serious noise, vibration or impact.
- Keep away from the place where strong alkaline or acid material is directly released and use an independent pipe line.
- When it is installed at kitchen, ensure not to pour water directly over the product for cleaning.
- Keep the sensor cable away from signal line, power source, power line or loaded line and use an independent pipe line.
- Note that the mark of ⚠ in terminal connection diagram is the safety expression for warnings or cautions.
- Avoid using the product close to the device generating noises(high frequency welder, high frequency sewing machine, high frequency radio, large capacity SCR Controller, etc).
- The use in any way other than what is instructed by the manufacturer may cause injury or property loss.
- It is not a toy and keep it out of reach of children's hand.
- The installation of the device should be performed by an expert or a qualified personnel without fail.
- We shall not take any responsibility for the damage caused by non-compliance with the above-mentioned warnings or cautions or by any consumer's mistake.

⚠ DANGER

- Danger from electrocution
 - Electric shock – Do not make contact with the AC terminal during the electric current application for this may result in electrocution.
 - When inspecting input power, make sure to cut input power.

2 Composition

Model	Sensor	Output	Temperature Range	Function
FOX-2003CC	NTC	Relay	°C : -55.0°C ~ 99.0°C °F : 67°F ~ 212°F	Temp.
FOX-2003CC-RS		Relay		Defrost
		Relay		FAN
FOX-2003CC-SR	NTC	SSR (12V DC30mA MAX)	485 communication	Temp.
		Relay		Defrost
		Relay		FAN

3 Name of Parts

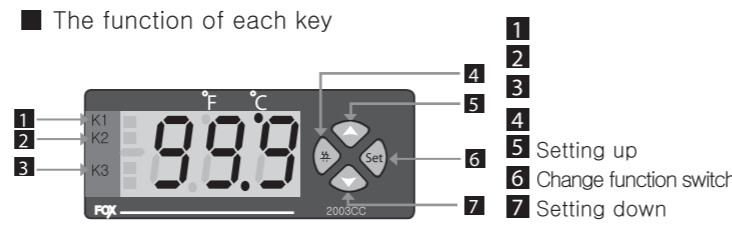

■ How to change the setting temp. for Main output

- ⊖ If press it once, the setting value is flickered.
- ⬆ or ⬇ the value can be UP & DOWN with this key.
- ⊕ A key for manual defrost
Press the key for more than 3 seconds to operate or stop the manual defrost.

• Mode setting for user

- ⊖ A key to enter to installer mode if press ⊖ for more than 5 sec. change with these keys.

4 Connection

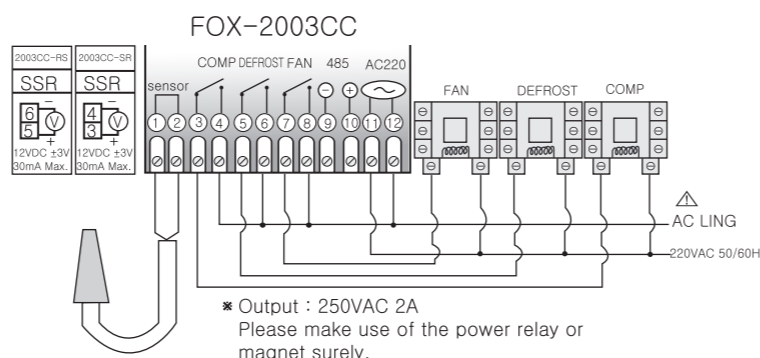

■ SSR junction

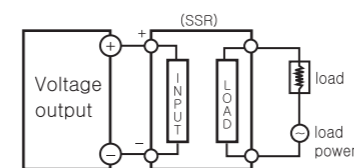

※ Please make sure that the SSR's capacity should be used more than load capacity.

■ Relay junction

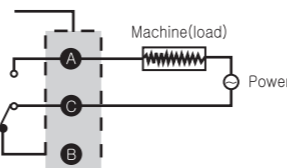

※ Relay access capacity is less than 250VAC 2A.
 Note that use of load exceeding capacity of contact may cause fusion of contact, poor contact, damage of relay, etc.

5 Size & Dimension

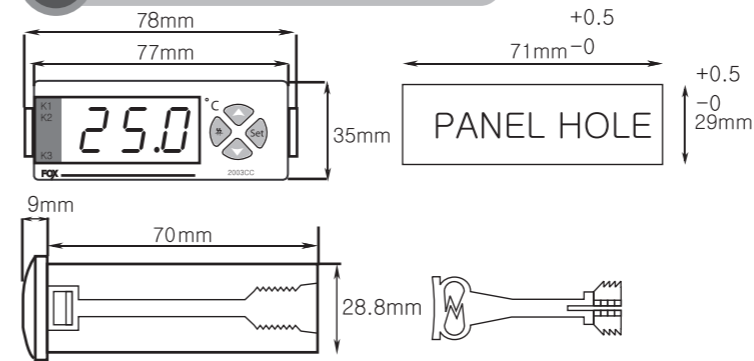

6 Temp. range & Set value when deliver

Display	Function	Celsius range	Fahrenheit range	set value when deliver	Remarks
	Setting Temp.	-55.0 ~ 99.9	-67 ~ 212	10.0	
Unit	Unit of Temp.	°C / °F		°C	°C : Celsius °F : Fahrenheit
HSP	setting for the highest limit of user	LSP ~ 99.9	LSP ~ 212	99.9	It is irrelevant to the relay output
LSP	setting for the lowest limit of user	-55.0 ~ HSP	-67 ~ HSP	-55.0	It is irrelevant to the relay output
dI S	Selection of the deviation style	P / Pn		P	Pn : deviation ± P : deviation +
dI F	Temperature deviation	0.1 ~ 19.9	1 ~ 35	1.0	
dL t	Delay time	0.00 ~ 9.99	0.00	0.00	(min.sec)
Cor	Correction of Temp.	-10.0 ~ 10.0	-18 ~ 18	0.0	correct for a discrepancy between the display temp. and real temp.
SEr	Sensor error	on / off	off	off	on : COMP ON off : COMP OFF
dtP	Comp. select when defrosting	on / off	off	off	on : COMP ON off : COMP OFF
doF	Defrost OFF time	0 ~ 99	4	4	hour, set up unit
don	Defrost ON time	0 ~ 99	10	10	minute, set up unit
ddt	COMP delay time setting after defrost	0.00 ~ 9.99	0.00	0.00	(min.sec)
FSt	FAN setting	1 ~ 4	1	1	refer to the chart
Fdt	FAN delay time after defrost	0.00 ~ 9.99	0.00	0.00	
Adr	Communication channel	01 ~ 99	0.1	0.1	
bPS	Communication speed	120 / 240 / 480 / 960 / 1920	120	120	120 : 1200bps 240 : 2400bps 480 : 4800bps 960 : 9600bps 1920 : 19200bps
LoC	Lock function	on / off	off	off	on : setting for the lock function off : setting for the unlock function (however, except for the setting temperature value)

	COMP ON	COMP OFF	DEFROST
F1	ON	OFF	OFF
F2	ON	ON	ON
F3	ON	OFF	ON
F4	ON	ON	OFF

- ※ Setting for the manual defrost
1. Manual defrost ON : Press the ⊕ key for more than 3 seconds. As soon as the K2 LED is flickered, the manual defrost is started and **don** is displayed.
 2. Manual defrost OFF : Under the operation of the manual defrost, press the ⊖ key for more than 3 seconds to stop the manual defrost. Or be closed automatically after **don** time.

7 Communication interface

specification	in conformity EIA RS485
max. speed	32 units (but, address setting can be upto 01~99)
ethod of communication	two wire half-duplex operation
synchronous system	asynchronous system
ommunication distance	1.2 Km
communication speed	1200/2400/4800/9600/19200bps(selectable)
StartBit	fixed 1bit
StopBit	fixed 1bit
ParityBit	none
DataBit	fixed 8bit
Protocol	BCC

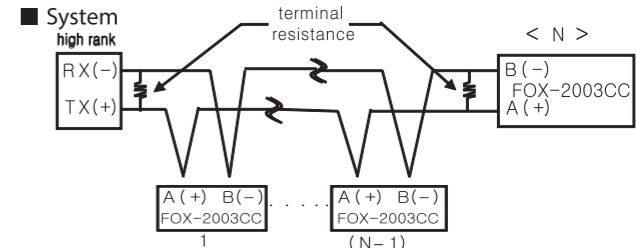

■ Definition between communication command and block

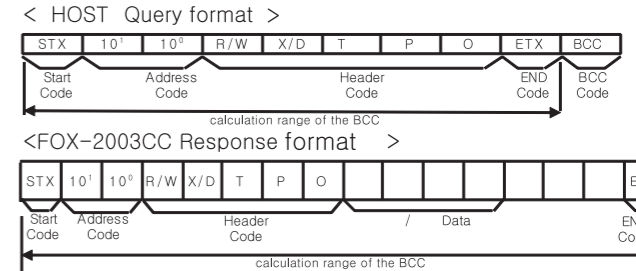

- ① Start Code
 - show the lead(head) of the block
 STX → [02H]
- ② ADDRESS CODE
 - A high rank system can discriminate the channel code number among FOX-2003CC.
 It is available to set between 01 and 99(BCD ASCII)
 (ex-in case of 01, 30H,31H)
- ③ Header Code
 - Show the command name as an alphabetic letter.
 RX(reading demand) → R[52H], X[58H]
 RD(reading response) → R[52H], D[44H]
 WX(writing demand) → W[57H], X[58H]
 WD(writing response) → W[57H], D[44H]
 TPO(temperature measuring value) → W[54H], P[50], O[30H]
- ④ Composition of data
 - Data is displayed as "Hexadecimal"
- ⑤ Decimal point → 0[30H] there is no "decimal point"
 1[31H] there is "decimal point"
- ⑥ Error → 0[30H] there is no "error"
 1[31H] interrupted of the sensor's cable
 2[32H] short-circuited error of the sensor

	COMP	DEFROST	FAN
0(30H)	X	X	X
1(31H)	O	X	X
2(32H)	X	O	X
3(33H)	O	O	X
4(34H)	X	X	O
5(35H)	O	X	O
6(36H)	X	O	O
7(37H)	O	O	O

- ⑦ END Code
 - Show the end (close) of the Block ETX → [03H]
- ⑧ BCC(Block Check Character)
 - Show the XOR arithmetic and logic values from the start(STX) to the ETX
 * The others : AS of not response of the ACK
 ① In case of not equivalent to the channel after receiving STX
 ② In case of generating the receive buffer overflow
 ③ In case of not equivalent to the communication's set values or baud rate
 * Treatment - in case of no response of the ACK
 ① Check the cable
 ② Check the communication's condition (set values)
 ③ If the main cause of the status is the noise, try to do communication practicing 3-times until recovering normally.
 ④ Change the communication speed in case of bring about the communication's error frequently.

Setting temperature

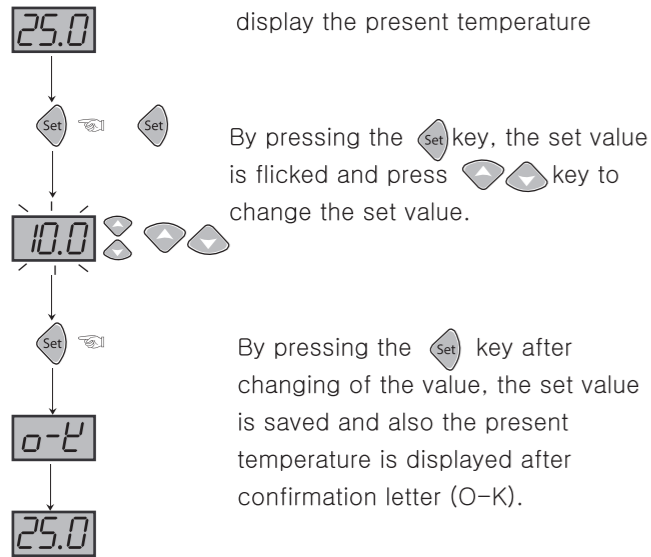

Temperature program setting

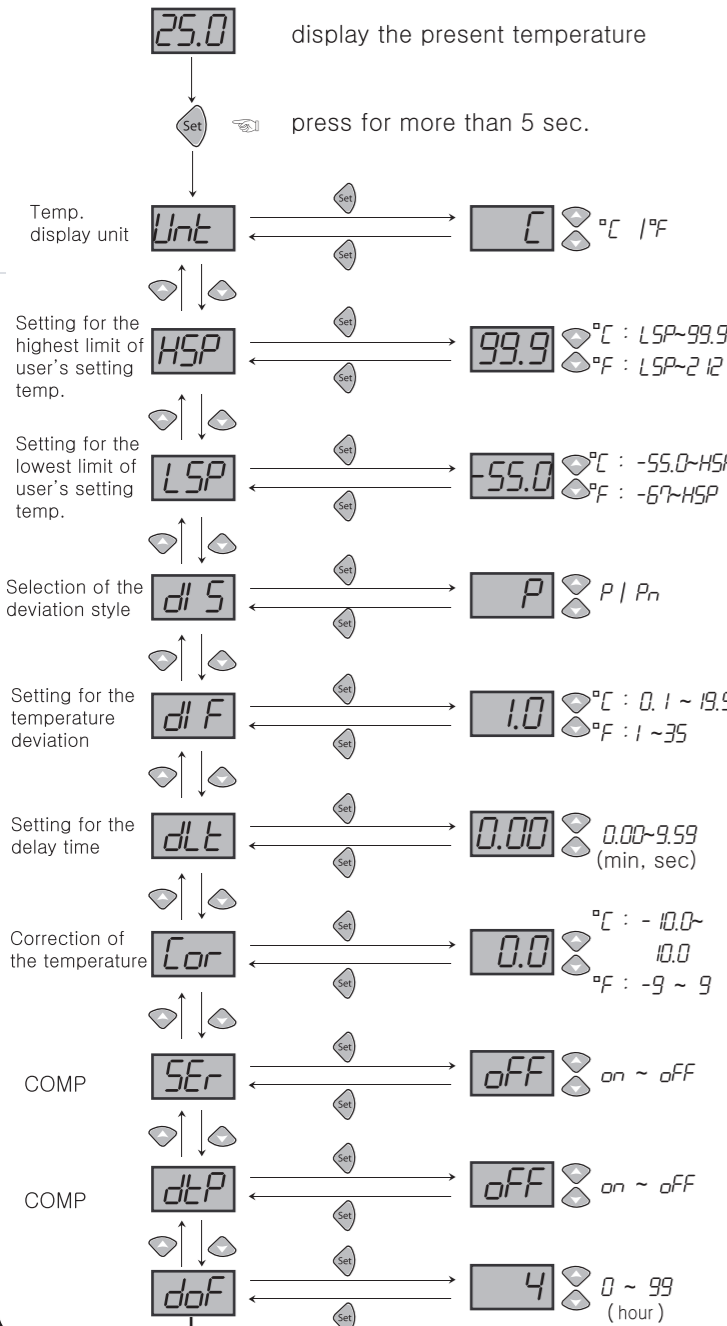

Unt : Change of the display unit
 °C : Celsius
 °F : Fahrenheit

Caution : If you change the display unit under operating this controller, please reset all of set values because all of setting values except ADR, BPS could be changed the setting value when delivery,

Celsius : HSP=99.9 LSP=-55.0 tYP=C dlS=P dlF=1.0
 dLt=0.00 Cor=0.0 SEr=off dtP=off don=4 doF=10
 ddt=0.00 FSt=1 Fdt=0.00 LoC=off

Fahrenheit : HSP=212 LSP=-67 tYP=C dlS=P dlF=1
 dLt=0 Cor=0 SEr=off dtP=off don=4 doF=10
 ddt=0 FSt=1 Fdt=0 LoC=off

HSP : Setting function of the highest limit of temperature range (maximum set point allowed to the end user)
 - Impossible to set up the set value more than HSP set value
 ex) HSP=25.0°C setting → impossible to raise the set value more than 25.0°C

LSP : Setting function of the lowest limit of temperature range (Minimum set point allowed to the end user)
 - Impossible to set up the set value less than LSP set value
 ex) LSP = 10.0°C setting → impossible to lower the set value less than 10.0°C

dlS : Selection of deviation style
 P : Output : +deviation (be off at setting point)
 Pn : Output : ±deviation(based on the setting point)

dlF : Setting for temperature deviation
 - In the ON/OFF control it needs at regular interval between ON and OFF. By operating the ON/OFF control frequently, the relay or its output contact can be damaged quickly and it also occurs the hunting (oscillation, chattering) by virtue of external noise. You can make use of the temperature deviation in order to protect its relay or contact and so on.

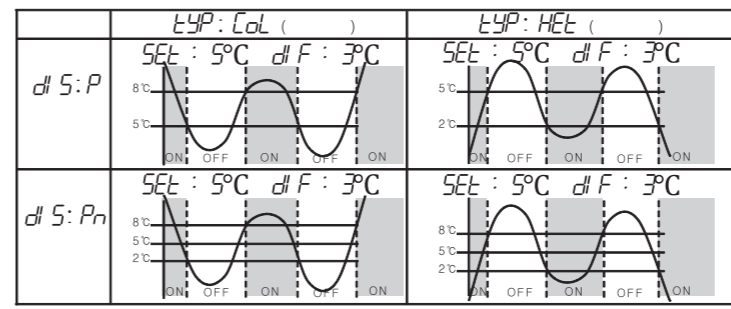
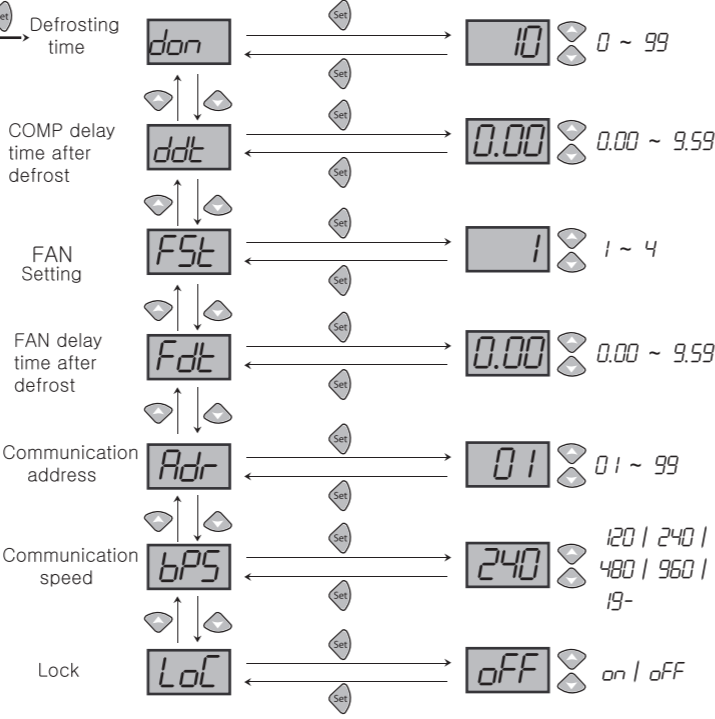

dLt : Delay time of the output
 - in case of operating the ON/OFF control very often (cooler, compressor, etc.)
 - to protect the operation machinery when re-input of the power supply or momentary stoppage of power supply

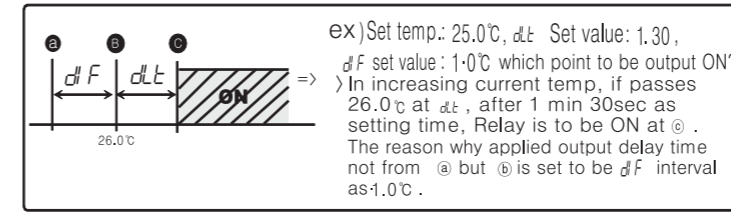

Cor : Correction of the present temp.
 The product itself has no problem, but the correction functioned for that if temp.differs between an error occurs in the input sensor from outside and basic temp. (Compare with mercury thermometer or existing thermometer)
 ex) real temp: 25.0°C Cor 0.0 → -3.0 display :28.0°C screen shown in 25.0°C if 3°C differs from the real temp.

SEr : Sensor error (o-E, S-E)
 COMP output setting : ON : continuously ON
 OFF : continuously OFF

dtP : Comp select when defrosting ON : continuously ON
 OFF : continuously OFF

don : Defrosting time
 Setting range 0 ~ 99 (min)
 When the defrost cycle, the defrost operation.

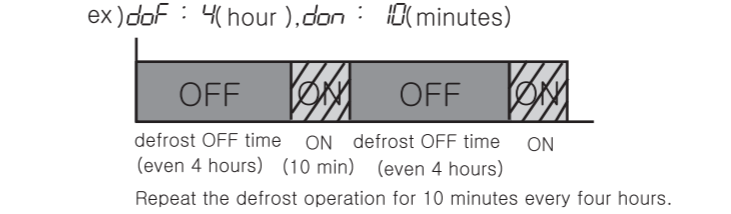

doF : Defrost OFF time
 Setting range 0 ~ 99 (hour)
 When the defrost cycle, the defrost operation.

ddt : COMP delay time after defrost
 Setting range 0.0 ~ 9.59 (min, sec)
 COMP output is ON after delay as much as setting time after defrost OFF

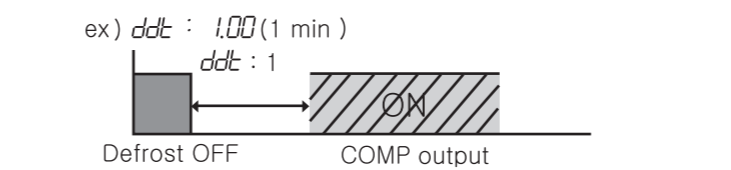

FSt : FAN setting (F1 ~ F4)
 refer to the program setting chart

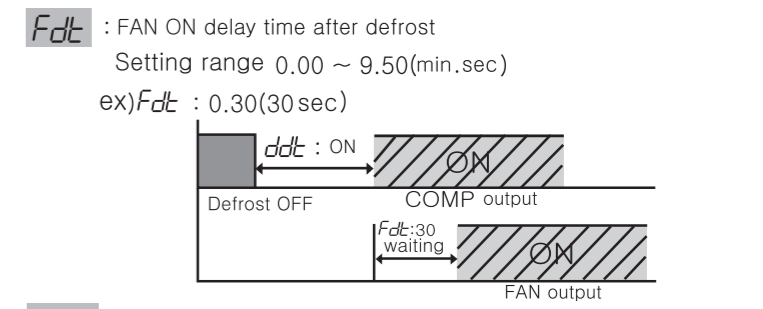

Adr : Should designate the channel 1~99 while RS485 communication.

bPS : Communication speed
 1200BPS / 2400BPS / 4800BPS / 9600BPS / 19200BPS

LoC : The lock function
 on : setting for the lock function
 off : setting for the unlock function

Application

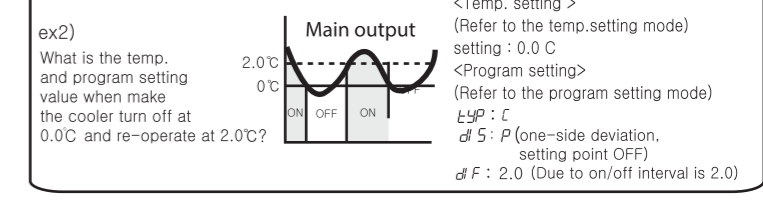
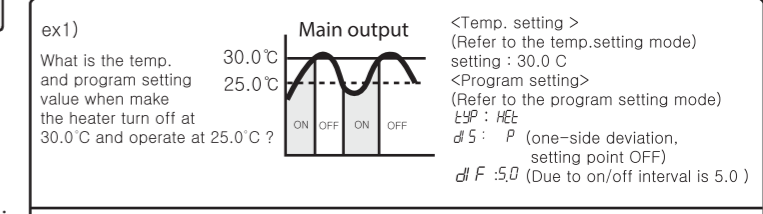

Model & Output spec

	2001CC	2002CC	2003CC	2001TX	2000TX	2003TX	2000RX
temp. output	o	o	o	o	o	o	-
alarm output	-	o	-	-	o	-	-
defrost output	-	-	o	-	-	o	-
FAN output	-	-	o	-	-	o	-
communication	o	o	o	o	o	o	o

10 How to diagnose a breakdown

- Indicating ERROR on using items
- This **Er1** is the damage of memory data for various of inner-DATA due to be got nosied strongly from outside while using this items.
- Please request us A/S by return.
- Although our controller is designed as the complementary measures regarding these noise from outside, it is not endurable against these noise with endlessly.
- If noise(2KV) disordering become an inflow, the inner-part will be damaged.
- When shows these letter **o-E** (open error), **S-E** (short error) it indicates that sensor has a problem.
- Please check the sensor.

* This device's specification can be changed without any notification to improve its quality

* Regarding the English-language manual, please download it at our homepage.

■ H. Office : 56, Ballyongsandan 1-ro, Jangan-eup, Gijang, Busan, Republic of Korea
 Factory : 56, Ballyongsandan 1-ro, Jangan-eup, Gijang, Busan, Republic of Korea

TEL : +82-51-819-0426
 FAX : +82-51-819-4562

e-mail : conotec@conotec.co.kr
 URL : www.conotec.co.kr

Main Products & Development
 - Digital Temperature / Humidity Controller
 - Digital Timer, Current/Voltage Meter
 - Other Products Development