

Right choice for ultimate yield

LSIS strives to maximize customers' profit in gratitude of choosing us for your partner.

Human Machine Interface

XGT Panel

iXP Series

User's Manual

iXP70-TTA
iXP80-TTA
iXP90-TTA



Safety Instructions

- Read this manual carefully before installing, wiring, operating, servicing or inspecting this equipment.
- Keep this manual within easy reach for quick reference.

LSIS

<http://www.lsis.com>

Before using the product...

To use the product safely and effectively, please read this instruction manual thoroughly before use.

- ▶ Please keep to the safety precaution, for it is to prevent accidents and potential danger from occurring.
- ▶ Safety precaution is classified into 'Warning' and 'Caution' and their meanings are as follows.

 **Warning** Violating the instruction may result in serious personal injury or death.

 **Caution** Violating the instruction may result in slight personal injury or product damage.

- ▶ The indicated illustrations on the product and in the manual have the following meanings.

 Be cautious, for danger may be present.

 Be cautious, for there is a possibility of an electric shock.

- ▶ After reading the instruction manual, keep it handy for quick reference.

Design Precautions



Warning

- ▶ **Install a safety circuit external to the HMI to protect the whole control system in case of external power supply trouble.**

Serious trouble may occur to the entire system due to erroneous output/operation of the HMI.

Design Precautions



Caution

- ▶ **In/output signal or communication cable should be at least 100mm apart from High-voltage/power wires.**

Otherwise, it may cause erroneous output/operation.

Installation Precautions



Caution

- ▶ **Use the HMI in an environment that meets the general specification contained in this manual or datasheet.**

Otherwise, it could result in electric shock, fire, erroneous operation or deterioration.

- ▶ **In case of much vibration in the installed environment, be sure to insulate the HMI from direct vibration.**

Otherwise, it could result in electric shock, fire or erroneous operation.

- ▶ **Be sure not to let foreign substances such as conductive debris inside the product.**

Otherwise, it could result in electric shock, fire or erroneous operation.

Wiring Precautions



Warning

- ▶ **Be sure to turn off the HMI and external power before wiring.**

Otherwise, it may result in an electric shock or damage to the product.



Caution

- ▶ **Wire correctly by checking each of the product's rated voltage and terminal layout.**

Otherwise, it may result in fire, electric shock or erroneous operation.

- ▶ **Tighten terminal screws with specified torque when wiring.**

If terminal screws are loose, it may result in short circuits, fire or erroneous operation.

- ▶ **Use the exclusive HMI 3-type grounding for the FG terminal.**

If not grounded, it may result in erroneous operation.

- ▶ **Be sure not to let any foreign substances such as wiring debris inside the module.**

Such debris may cause fire, damage or erroneous operation.

Startup and Maintenance Precautions

Warning

- ▶ **Do not touch the terminals while power is on.**
Otherwise, it may cause electric shock or erroneous operation.
- ▶ **Turn off the HMI and external power when cleaning or tightening the terminal.**
Otherwise, it may cause electric shock or erroneous operation.
- ▶ **Do not charge, disassemble, heat, short circuit, solder, etc. the battery.**
Mishandling the battery may cause overheating, crack, fire and may result in injury or fire.

Caution

- ▶ **Do not disassemble PCB from the product case or modify the product.**
Otherwise, it may result in fire, electric shock or erroneous operation.
- ▶ **Use cellular phone or walky-talky at least 30cm away from the HMI.**
Otherwise, it may result in erroneous operation.

Disposal Precaution

Caution

- ▶ **When disposing of this product or battery, treat it as industrial waste.**
Otherwise, it may cause poisonous pollution or explosion.

Revision History

Version	Date	Contents	Revised location
V1.0	'11.11	First Edition	-



※ The number of User's manual is indicated the right side of the back cover.

© LSIS Co., Ltd 2013

All Rights Reserved.

Contents

Chapter. 1 General Introduction..... 1-1~1-7

1.1 How to use the Instruction Manual	1-1
1.2 Feature	1-3
1.3 Terminology.....	1-7

Chapter. 2 System Configuration 2-1~2-8

2.1 Part Names.....	2-1
2.2 System Configuration	2-4

Chapter. 3 Standard Specification 3-1~3-5

3.1 General Standards.....	3-1
3.2 Function Standards.....	3-2

Chapter. 4 System Configuration4-1~4-11

4.1 Touch Calibration	4-2
4.2 Backlight Setting	4-3
4.2.1 PIR sensor.....	4-4
4.3 Date Time Setting	4-5
4.4 Ethernet Setting	4-6
4.5 Environment Setting.....	4-7
4.6 Sound Setting	4-8
4.7 XP-Remote Setting.....	4-10
4.8 Buzzer Setting.....	4-11

Chapter. 5 Diagnostics..... 5-1~5-10

5.1 Screen Diagnosis	5-2
5.2 Touch Diagnosis	5-3
5.3 Backup Memory Diagnosis.....	5-4
5.4 Flash Memory Diagnosis Function.....	5-5
5.5 CF Card Diagnosis	5-6
5.6 Serial Communication Diagnosis.....	5-7
5.7 SD Card Diagnosis.....	5-9
5.8 USB Memory Diagnosis.....	5-10

Chapter. 6 Viewing Information of PLC Connection Status 6-1~6-8

6.1 PLC Communication Configuration Settings 6-2
 6.2 Connection Information 6-3
 6.3 PLC Information..... 6-4
 6.4 History of PLC Error 6-4
 6.5 History of PLC Mode Conversion 6-5
 6.6 History of PLC Power 6-5
 6.7 History of PLC System 6-6
 6.8 N:1 Settings 6-7
 6.9 Program Monitor 6-8

Chapter. 7 Storage Function..... 7-1~7-7

7.1 General Introduction 7-1
 7.2 Downloading Project through the Storage Equipment 7-2
 7.3 Uploading Project through the Storage Equipment 7-3
 7.4 Updating the Device through Storage Equipment 7-4
 7.5 Select a USB Storage Device 7-5
 7.6 Select a USB Storage Device while Monitoring a Project 7-6

Chapter. 8 XGT Panel SW Update..... 8-1

8.1 General Introduction 8-1

Chapter. 9 File Backup through External Storage Equipment 9-1~9-8

9.1 Path Structure in case of File Backup..... 9-1
 9.2 Operation setting when there is no space for backup..... 9-4
 9.3 Structure of path of video file and video capture files 9-4
 9.4 Monitoring Connection Status of External Storage Equipment 9-6
 9.5 Safety Removal Switch 9-7

Chapter. 10 Installation and Wiring..... 10-1~10-8

10.1 Installation 10-1
 10.1.1 Installation environment 10-1
 10.1.2 Notice in handling..... 10-2
 10.1.3 Notice in installing the panel 10-2

Contents

10.2 Wiring	10-5
10.2.1 Power wiring.....	10-5
10.2.2 Ground wiring.....	10-8

Chapter. 11 Maintenance11-1~11-3

11.1 Maintenance.....	11-1
11.2 Daily Maintenance	11-1
11.3 Periodical Maintenance	11-2

Chapter. 12 EMC Standard Certification 12-1~12-2

12.1 Requirement for EMC Standard Certification	12-1
12.1.1 CE standard certification	12-1
12.1.2 MIC standard certification	12-2
12.2 Requirement for Low Voltage Command Suitability.....	12-2
12.2.1 Standard certification for XGT Panel.....	12-2
12.2.2 Selection of XGT Panel	12-2

Appendix 1. Troubleshooting..... Appendix1-1~Appendix1-20

1. Type of Problem.....	Appendix 1-1
2. Problem when Starting	Appendix 1-1
3. Reaction Problem when Touching.....	Appendix 1-2
4. Display Problem of Figure and Object.....	Appendix 1-3
5. Communication Problem.....	Appendix 1-7
6. CF/SD/USB Removal of Memory Card.....	Appendix 1-8
7. Error Message during Execution of Program.....	Appendix 1-9

Appendix 2. Dimension.....Appendix 2-1~ Appendix 2-3

Chapter 1. General Introduction

1.1 How to use the Instruction Manual

This instruction manual provides information such as specification, how to use, etc. of the product needed to operate iXP series of XGT Panel.

iXP series is characterized as follow;

Item	symbol	Contents	Remarks
(A) LCD Size	70	26cm (10.4")	-
	80	31cm (12.1")	-
	90	38cm (15")	-
(B) LCD Type	B	STN Mono	Not available
	T	TFT Color	-
(C) Touch Type	T	Touch	-
(D) iXP Type	A	Advance	-
	M	Multimedia	Available later
(E) Power type	AC	AC 100-240V	-
	DC	DC 12/24V	-

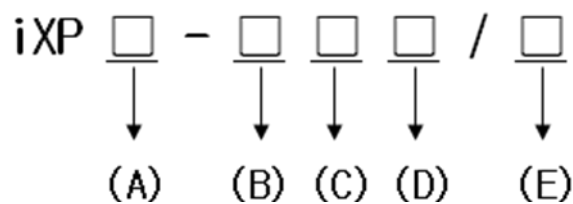

Chapter 1. General Introduction

The user manual's configuration is as follows.

Sequence	Category	Contents
Chapter 1	General Introduction	It describes this manual's configuration, product's feature and term.
Chapter 2	System Configuration	It describes feature and system configuration of each XGT Panel.
Chapter 3	Standard Specification	It describes XGT Panel's general and function specification.
Chapter 4	System Configuration	It describes XGT Panel's system configuration.
Chapter 5	Diagnostics	It describes XGT Panel's self-diagnosis.
Chapter 6	Viewing information of PLC Connection Status	It describes the way on connection status information of PLC which is connected with XGT Panel.
Chapter 7	Transmission of Project from USB Storage Device	It describes the way to execute the project by using USB/CF/SD storage device.
Chapter 8	XGT Panel SW Update	It describes the way to update engine at XGT Panel.
Chapter 9	Backup files by using Storage Devices	It describes the way to backup recipe, logging and etc. files by using storage devices.
Chapter 10	Installation and Wiring	It describes an installation, wiring and caution for reliability of PLC system.
Chapter 11	Maintenance	It describes inspection category and method for long normal operation of PLC system.
Chapter 12	EMC Standard	It describes system configuration for EMC standard.
Appendix 1	Troubleshooting	It describes a variety of error contents and measure.
Appendix 2	Dimension	It describes the dimension of XGT Panel.
Appendix 3	Warranty and Environment Policy	

Remark

This manual doesn't describe connection with XP-Builder and PLC. For their own function, Please refer to the related manuals.

1.2 Feature

iXP series has the following features.

(1) Various types of external interface

- (a) Supporting various storage media of USB, CF card, and SD card, it maximizes the customer's usability. Multimedia type provides interfaces of video input, audio input, video output, and audio output so as to add the functions needed to exert high performance. Extended interface designed to stack maximum three layers allows mounting a variety of communication cards on it. In addition, the right part of extended interface is designed so as to mount VM module that allows inputting 4-channel video.

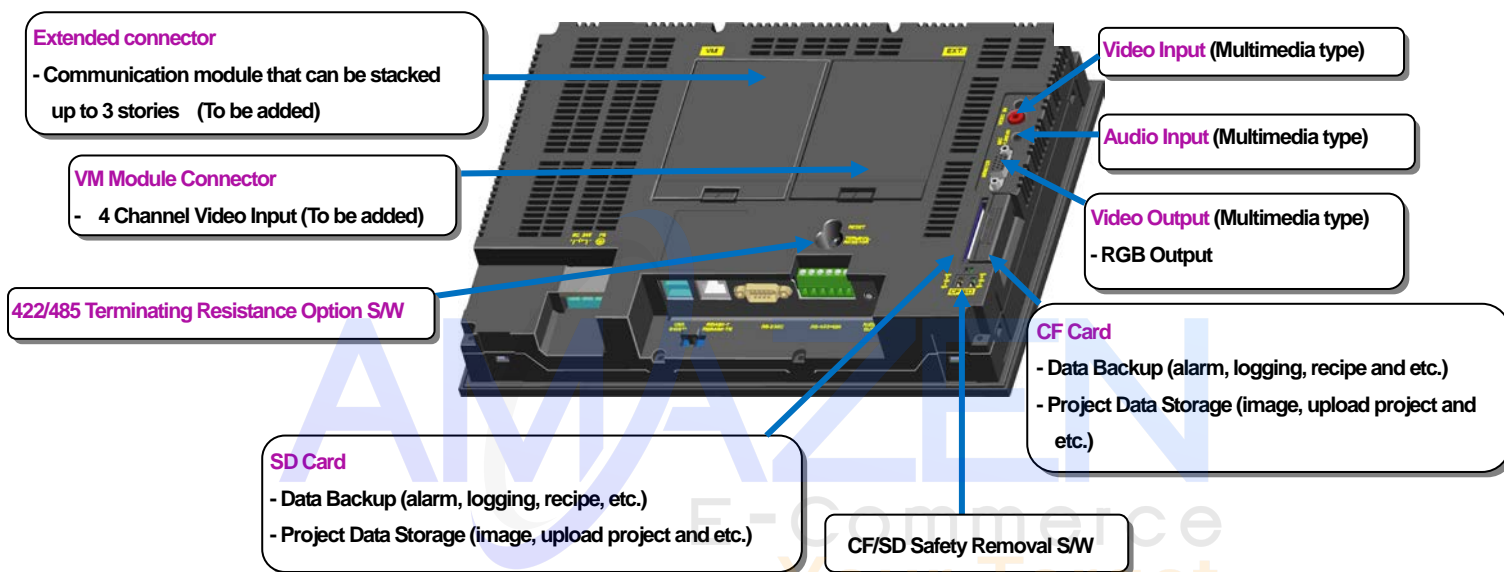

- (b) Presence sensor is placed at the front upper side so as to control backlight power source as it detects the presence. This enables the user to turn on/off backlight either by touch or as it detects a movement of human body or not, and thereby contribute to energy saving. In addition, one each channel of USB Host and Device is placed at the front side so that the user can access with ease. That is, USB device is provided in such a method of basic communication connection with PC so that the user can easily download the project through XP-Builder. Furthermore USB HOST 1 Channel located at the front side allows the user to insert and remove the storage media with ease.

Chapter 1. General Introduction

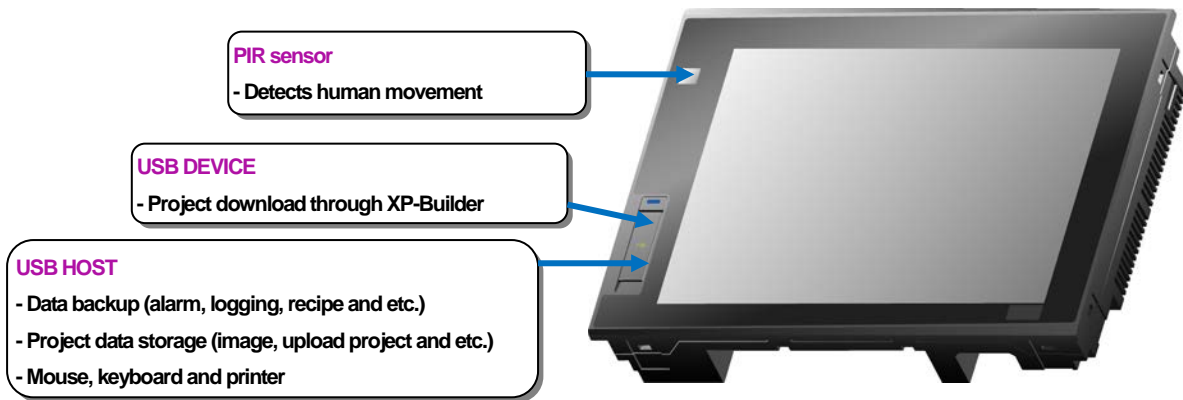

(c) Various communication connectors are placed at the lower side so that it can be connected in a variety of types with the control device such as PLC, inverter, etc. With two channels of USB HOST attached, it provides total 3 USB Hosts including one channel at front side. This enables the user to diversely connect USB-based peripheral device that uses mouse, key board, printer, etc. as well as for the purpose of backup.

- Through RS-232C, RS-422/485, Ethernet (10Base-T /100Base-TX) communication, it can be connected with control device.

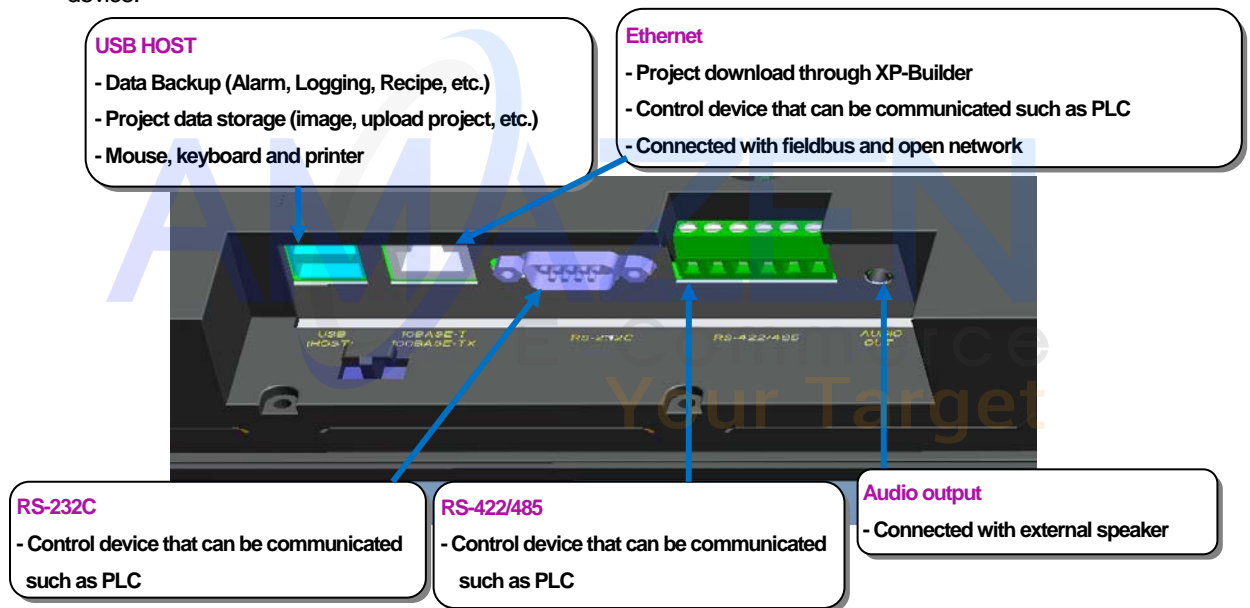

(2) Based on Windows CE

(a) Adoption of Microsoft Company's Windows CE

- Windows CE 6.0

(b) Advantage

- It provides stable software capacity by using Microsoft Company's platform.
- It can process diverse function simultaneously.
- It provides diverse interface including Ethernet, USB and CF/SD card.
- The user interface including mouse and keyboard can be connected.
- It has high flexibility like computer software.
- Fast reaction is available when adding new equipment.
- Wide data sharing and management with upper system is available. (Later)

(3) Improvement of project transmission time

(a) It provides Ethernet which is faster than RS-232C.



(b) It provides the transmission function from USB storage device.

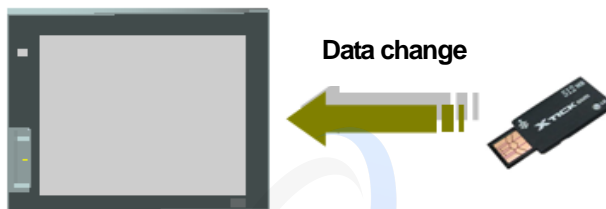

(4) High quality screen

(a) It provides the high quality screen and clearness by high quality LCD.

- It adopts TFT LCD which supports the 24-bit Color.

(b) It provides diverse graphic type.

- It is available to express precisely and actually.
- It provides the simple moving function with GIF support.

(5) Analog touch Panel

(a) It adopts analog (resistor film method) Touch Panel.

- Visibility is improved without the grids.

(b) It provides high touch resolution.

- It can control Touch Panel precisely.

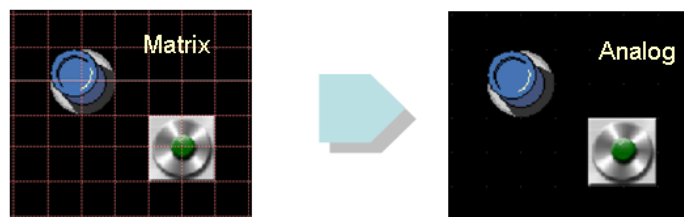

Chapter 1. General Introduction

(6) Multilingual and diverse font

(a) It supports the multilingual function.

- It transmits the Windows/User font used in computer to XGT Panel.
- Additional language development is not necessary.
- Multilingual language is an advantage of Windows CE.

(b) It can express four kinds of language simultaneously.

- It can express 8 kinds of language simultaneously.
- Language switching is available by using special switch during operation.

(c) It can provide the various fonts.

- Various expressions are available by using the Windows/User font.
- Font size and type can be adjusted freely.

(7) Advanced function

(a) Alarm function

- The History alarm can be classified alarm group and alarm list and selected alarm can be expressed by alarm search.
- The Flow alarm indicates current or the latest alarm at the bottom of screen.
- The System alarm indicates the important problems from operation.
- It provides 256Kbyte areas for backup.

(b) Logging function

- It provides conditional logging according to device condition and continuous periodic logging which operates periodically according to time and device status.
- It provides 512Kbyte areas for backup.
- Backup into CF/SD card or USB storage device is available.
- Backup data's type is stored in Excel, it is easy to use.

(c) Recipe function

- It provides READ/WRITE function.
- It provides 128Kbyte areas for backups. [General recipe: 255 (255 blocks and set up to 10,000 double word for each one of them), File recipe: 5000]
- Backup into the CF/SD card or USB storage device is available.
- Backup data's type is stored in Excel, it is easy to use.

(d) Scheduler function

- It can be set up to Max. 32.

(e) Print function

- It provides a Screen/Alarm print function.
- It can be printed by USB printer.

(f) Script function

- It provides more flexible function by user Script.
- It can be diversely applied to such as including Global/Object/Screen indication and so on.

(g) Providing sound output function

- It basically provides audio output function in all the types.
- It allows connecting with amp built-in external speaker. With the sound function set, it enables to output a variety of WAV files.

- (h) Providing video input function (Multimedia type only)
 - Analog camera allowing input of signals such as NTSC, PAL, SECAM, etc. can be connected using coaxial cable.
 - It provides preview function that allows watching video input data, and record/play functions as well.
 - It provides the function that stores video input data for maximum 120 seconds and then play it using a specific trigger.
 - (i) Providing sound input function. (Multimedia type only)
 - Sound source can be input through MIC/Line-IN, which can be selected by S/W.
 - Sound input data is stored together when recording the video.
 - It provides an optional function of outputting the sound input data to the speaker.
 - (j) Providing video output function. (Multimedia type only)
 - It provides the function of outputting HMI screen to PC in HMI resolution by connecting it to the PC using RGB cable.
- (8) Stable product suitable for international standards
- (a) CE, KC standard acquisition
 - (b) UL(cUL) standard acquisition

1.3 Terminology

It describes terms used in this manual.

Term	Definition	Remarks
Module	A standard element that has a specified function which configures the system. Devices such as I/O board, which inserted onto the mother board or base unit.	Ex.) CPU module Power module, I/O module
Unit	A single module or group of modules that perform an independent operation as a part of PLC system.	Ex.) Basic unit, Extension unit
PLC system	System consisted of PLC and peripheral device which can be controlled by user program.	-
XP-Builder	Software used to write and edit the project.	-
XP-Manager	It is the software for edition, download, monitoring to realize data communication between XGT Panels through XP Link with online control function.	
XP-Remote	Software used to remote monitor and control the XGT Panel	
Cnet module	Computer Link	-
FEnet module	Fast Ethernet Network	-
RTC	Abbreviation of 'Real Time Clock'. It is used to call general IC that contains clock function.	-

Chapter 2 System Configuration

Characteristic of each iXP series and its system configuration are as follow;

2.1 Part Names

2.1.1. iXP70 (80/90)-TTA /AC (DC)

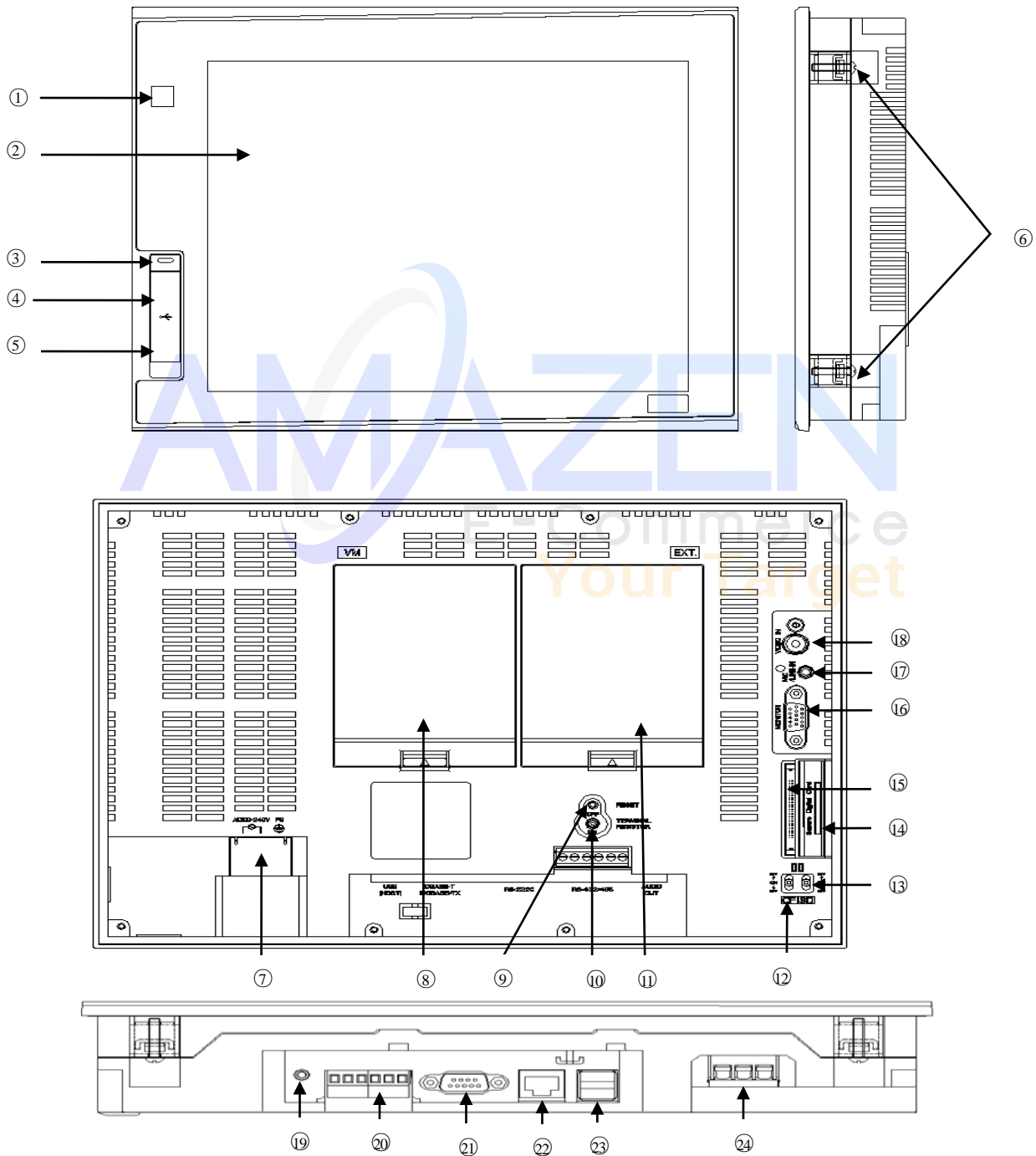

Chapter 2 System Configuration

No	Name	Description
①	PIR sensor	Sensor that detects human movement
②	Front Part	1) Analog Touch Panel: Input by user's touch 2) LCD: Screen indication
③	Power status LED	Indicating the state of device (On: Green)
④	USB Device	1) Logging/Recipe/Screen Data Backup 2) Send project data and XP-Run time 3) Receive back data and project file
⑤	USB Interface	Composed of three ports (Front side 1 port, Lower end 2 ports) 1) USB Memory Connection: Backup of data such as alarm/logging/recipe and storage of screen data 2) USB Memory Connection: Send/Receive project data, Send XP-Runtime 3) User's Interface Connection: Using mouse/keyboard 4) Printer connection: Printing function
⑬		
⑥	Panel Mounting Part	Fixing XGT Panel on the panel using bracket
⑦	Power Terminal Cover	Prevention from electric shock
⑧	VM Module	4 channels Video Input → Optional board to be developed later
⑨	Reset Switch	Hardware Reset Switch
⑩	RS-422/485 Terminating Resistance Switch	RS-422/485 Terminating Resistance On/Off → See Communication Instruction Manual 2.5.1 Switch
⑪	Extended Interface	Communication, I/O Option Module 3 Units Mounted → Optional board to be developed later
⑫	CF HOT SWAP Switch	CF Card Safety Removal Switch
⑬	SD HOT SWAP switch	SD Card Safety Removal Switch
⑭	CF Card Interface	1) Backup of data such as alarm/logging/recipe and storage of screen data 2) Send/Receive project data, Send XP-Runtime
⑮	SD Card Interface	1) Backup of data such as alarm/logging/recipe and storage of screen data 2) Send/Receive project data, Send XP-Runtime 3) Window CE OS Update Function (Can be used with DIP S/W set)
⑯	Video Output	1 channel Video Output(RGB Output) → Multimedia type only
⑰	Audio Input	1 channel Audio Input(MIC/LINE-IN)→ Multimedia type only
⑱	Video Input	1 channel Video Input (NTSC/PAL/SECAM supported) → Multimedia type only
⑲	Audio Output	1 channel Audio Output
⑳	RS-422/485 Connector	RS-422/485: PLC or Control Device Communication
㉑	RS-232C Connector	RS-232C: PLC or Control Device Communication

No	Name	Description
②②	Ethernet Terminal	Ethernet: 10Base-T / 100Base-TX 1) Send Project Data 2) Receive backup data and project file 3) Send XP-Runtime 4) PLC/Control Device Communication
②④	Power Terminal	Composed of Power Input and FG Terminal

Note

- (1) For further details on connection of communication, please refer to Communication Instruction Manual.
 (2) For further details on installation, please refer to the Chapter 10.

When you unpack the produce box to use XGT Panel, you can find prevention switch mounting on the device setting switch that prevents battery discharge. Device setting switch consists of 6 switches. Of them, 3rd switch has battery discharge preventing function. With this prevention switch upward to A, it starts operating backup function.

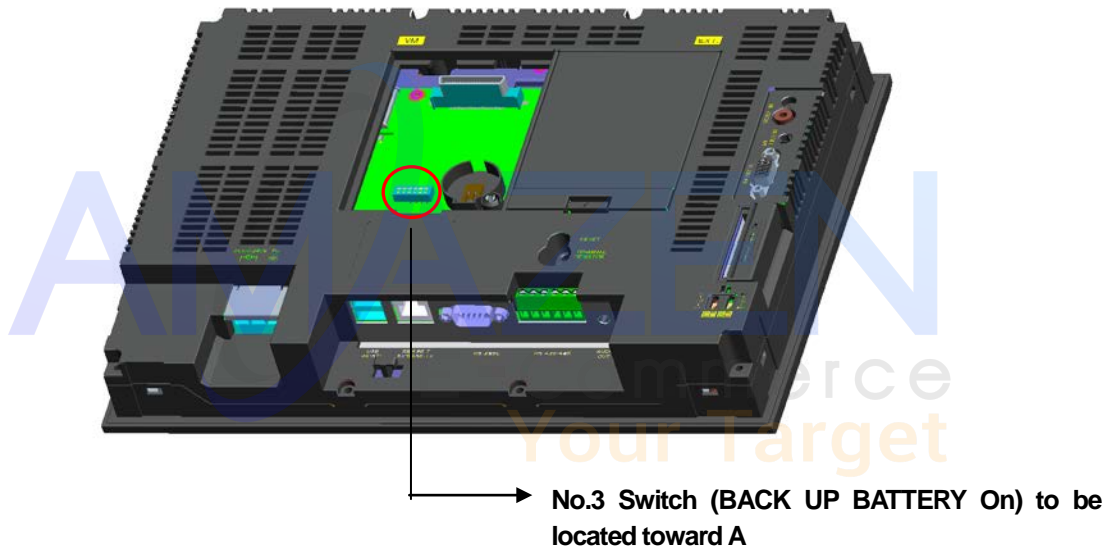

Device setting switch is made up of followings;

Pin Number	Configuration	Function
No.1	Reserved	
No.2	A Config.	NAND FLASH is used for booting (default)
	B Config.	NAND FLASH is not used for booting
No.3	A Config.	BACK UP BATTERY On
	B Config.	BACK UP BATTERY Off (default)
No.4	A Config.	Watchdog function On (default)
	B Config.	Watchdog function Off
No.5	A Config.	SD Card is used for booting
	B Config.	SD Card is not used for booting (default)
No.6	A Config.	USB, UART is used for booting
	B Config.	USB, UART is not used for booting (default)

Chapter 2 System Configuration

Be sure not to flip switches Nos. 2, 5, and 6 toward A at the same time. Normally it is recommended to set switch No.2 toward A. If you boot it with switches Nos. 2, 5, and 6 to A at the same time, it may cause malfunction of booting sequence resulting in white screen and abnormal booting.

2.2 System Configuration

(1) PC and its Construction

In order to use XGT Panel, it is necessary for XP-Builder to prepare project data and transmit it to XGT Panel. Normally you can connect with XGT Panel using USB 2.0 Device. Maximum Communication speed is 480Mbps.

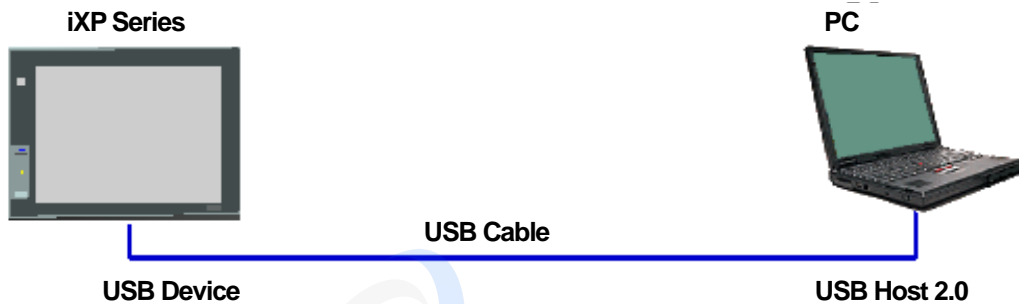

With Ethernet in use, you can transfer project data more quickly. With LAN environment built in the following configuration, you may use it more easily and effectively.

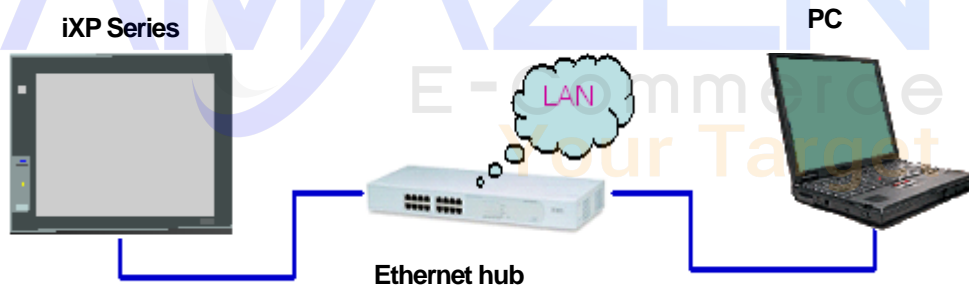

1:1 connection will be supported just in case LAN environment is not built. (However, LAN cable made of cross cable is required.)

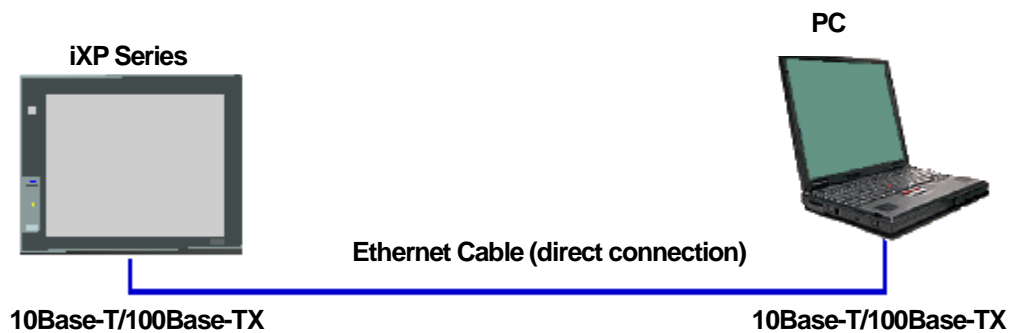

If it is impossible to transfer project data using Communication, you can use USB storage device, SD memory Card, and CF memory Card. For how to use in details, please see the Chapter 7 and XP-Builder User's Manual.

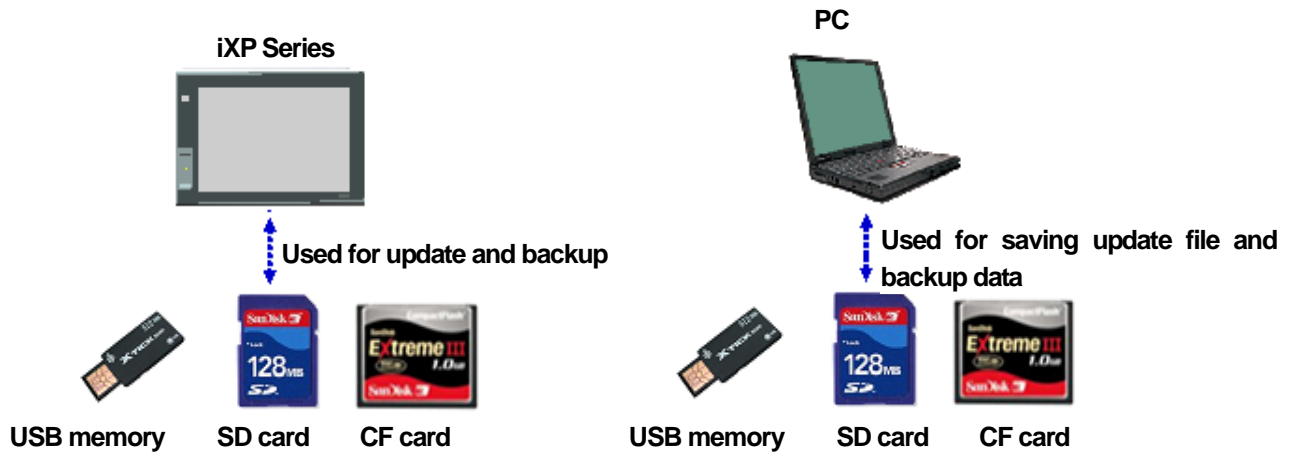

(2) PLC and its Construction

With RS-232C cable in use, you can connect it up to 15m in a direction 1:1 connection.

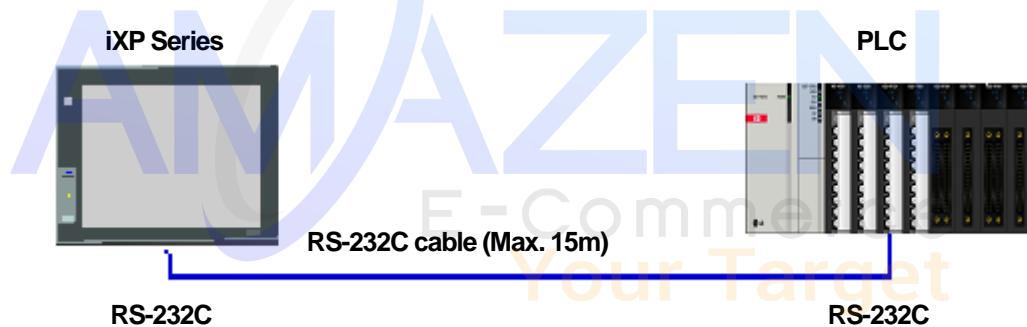

With RS-232C to RS-422/485 Converter in use, you can connect it in extended length. But, it doesn't support 1: N connection.

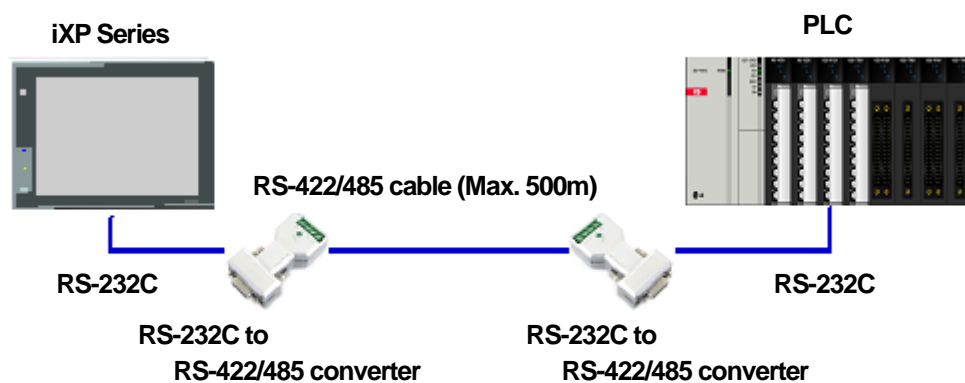

Chapter 2 System Configuration

With RS-232C wireless converter in use, it enables communication between XGT Panel and control device

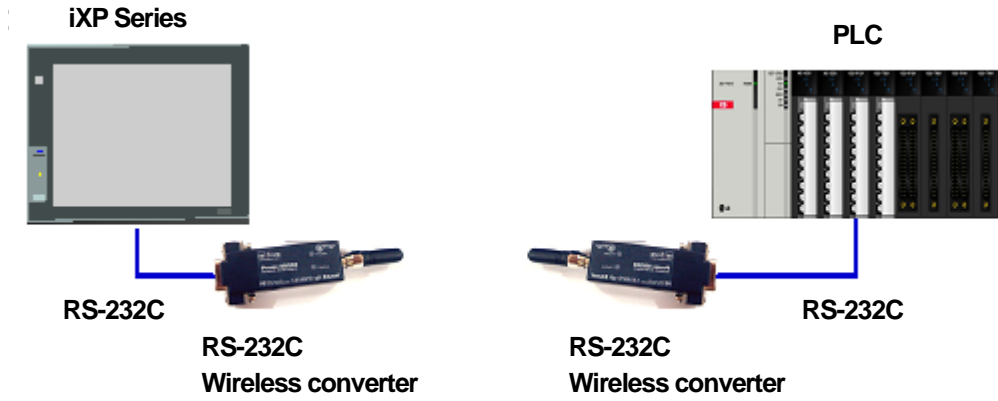

With RS-422/485 cable in use, it enables connections such as 1:1, 1: N, N: 1 and N: M up to 500m.

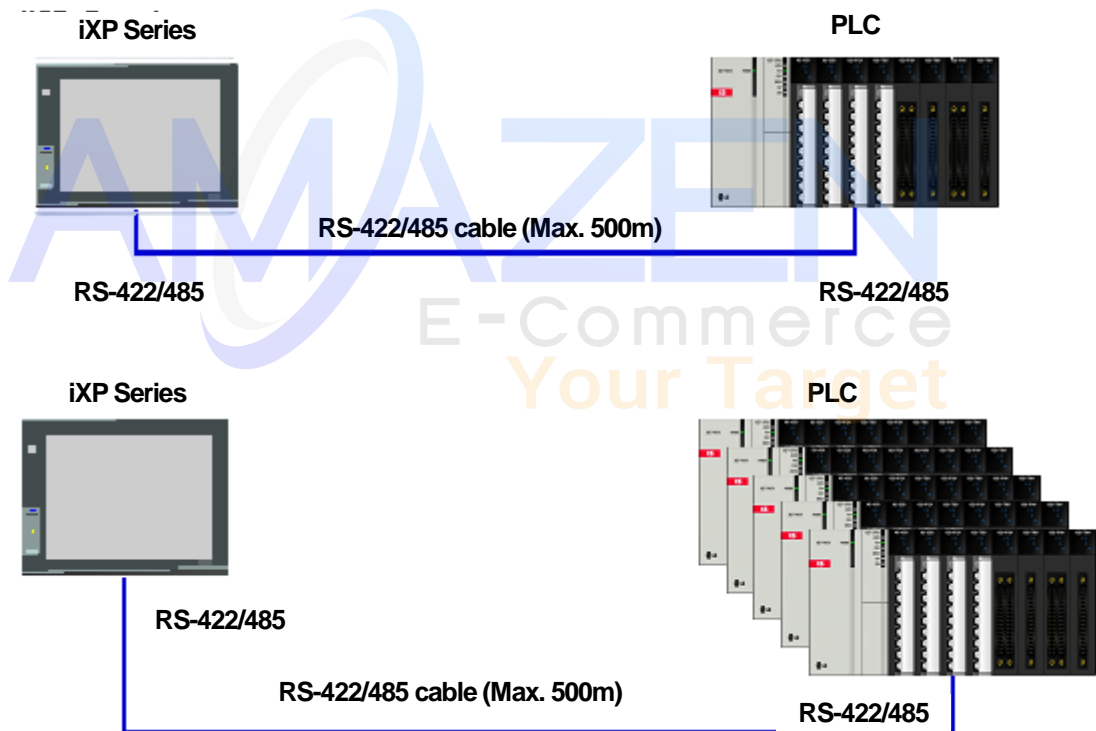

With N: 1 and N: M in connection, it enables connection in a RS-485 method.

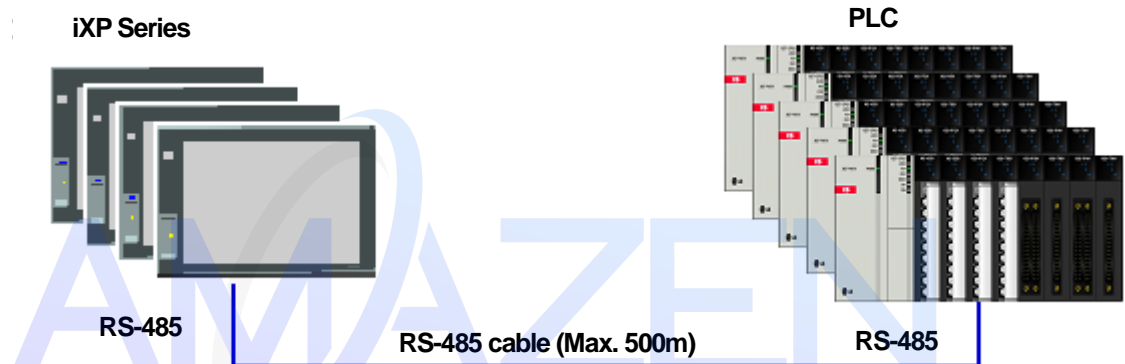
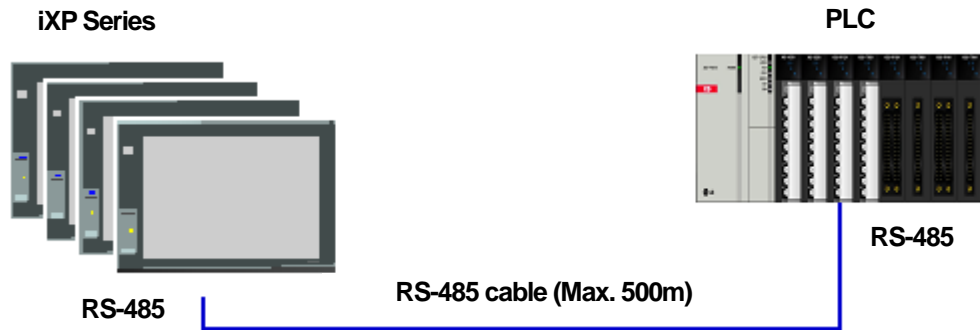

It enables communication configuration using LAN through Ethernet switch hub and communication configuration using a direct cable.

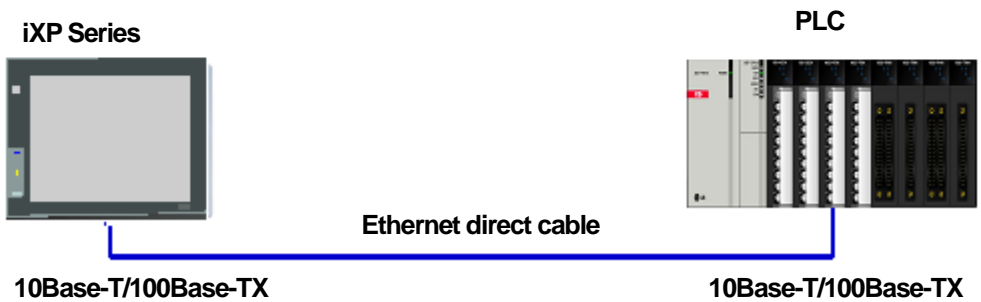
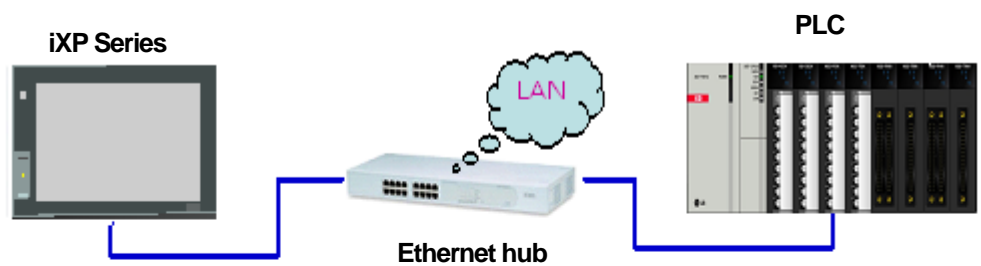

Chapter 2 System Configuration

With LAN in use, it enables to connect multiple numbers of XGT Panels with the control device. It also enables remote control from PC and operation through a data server.

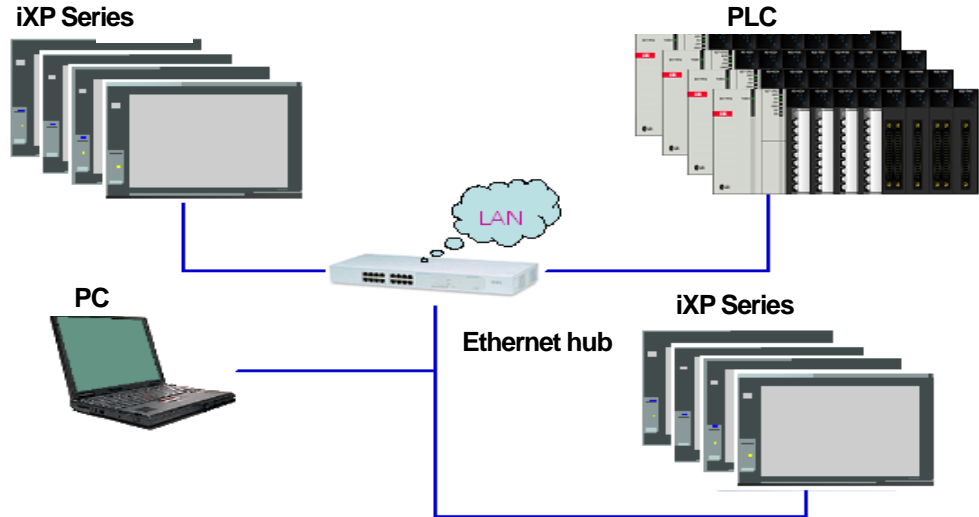

(3) Multimedia function

Through Video Input/Output, Audio Input/Output functions, it provides multimedia functions such as remote monitoring, screen data indication, sound effects, etc (But, the function except Audio Output can be supported by multimedia-type only)

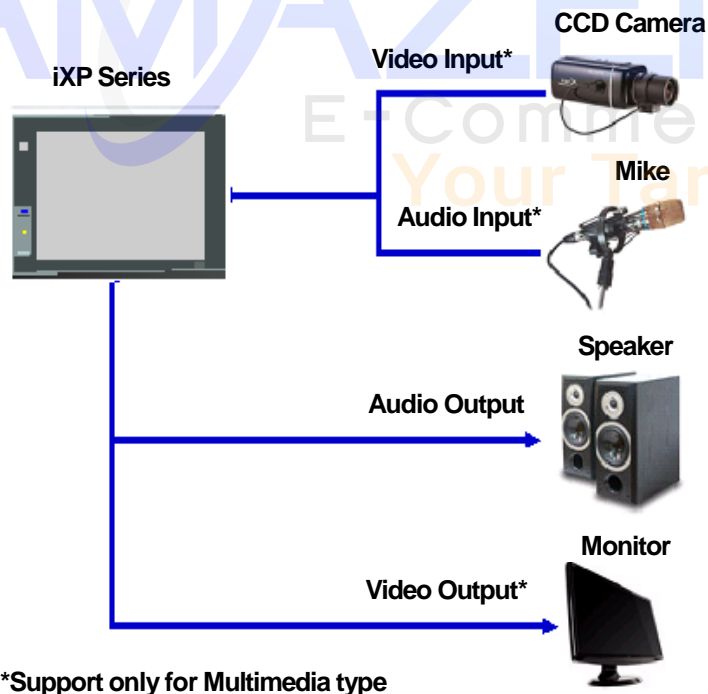

Note

- (1) For how to make Ethernet cable, please see the Communication User's Manual.
- (2) For how to transfer project, please see XP-Builder User's Manual.

Chapter 3. Standard Specification

3.1 General Standards

iXP Series general standard is as follows.

No.	Category	Standard			Related standard	
1	Ambient operating temperature	0°C ~ +50°C			-	
2	Storage temperature	-20°C ~ +60°C			-	
3	Operating humidity	10 ~ 85%RH, non-condensing.			-	
4	Storage humidity	10 ~ 85%RH, non-condensing.			-	
5	Vibration resistance	Occasional vibration			count 10 times each in X, Y and Z direction	IEC 61131-2
		Frequency	Acceleration	Amplitude		
		$5 \leq f < 9\text{Hz}$	-	3.5 mm		
		$9 \leq f \leq 150\text{Hz}$	9.8m/s^2	-		
		Continuous vibration				
		Frequency	Acceleration	Amplitude		
		$5 \leq f < 9\text{Hz}$	-	1.75 mm		
		$9 \leq f \leq 150\text{Hz}$	4.9m/s^2	-		
6	Shock endurance	* Maximum shock acceleration: 147m/s^2 (15G) * Duration time: 11ms * Pulse wave: half sine pulse (3 times each in X, Y and Z directions)			IEC 61131-2	
7	Noise Immunity	Square wave impulse noise	AC: $\pm 1,500\text{V}$ DC: $\pm 1,000\text{V}$		LSIS Standard	
		Electrostatic discharge Immunity	$\pm 6\text{ kV}$ (Discharge by contact) $\pm 8\text{ kV}$ (Air discharge)		IEC 61131-2 IEC 61000-4-2	
		Radiated electromagnetic field noise	80 ~ 1000 MHz, 10 V/m		IEC 61131-2 IEC 61000-4-3	
		Fast transient & Burst noise	Category	Power module	Communication interface	IEC 61131-2 IEC 61000-4-4
	Voltage	2 kV	1 kV			
8	Environment	Free from corrosive gases and excessive dust			-	
9	Operating height	Up to 2,000m (6,562 ft)			-	
10	Pollution degree	2 or less			-	
11	Cooling method	Self-cooling			-	

Chapter 3. Standard Specification

Remark

- (1) IEC(International Electro technical Commission)
: International private group facilitating international cooperation of electric/electronic standardization, issuing international standards and operating the compliance evaluation systems.
- (2) Pollution degree
: As an index representing the pollution degree of an environment to determine the insulation of a device, pollution degree 2 generally means the status generating non-conductive contamination. However, it also contains the status generating temporarily conduction due to condensation.

3.2 Function Standards

iXP Series function standard is as follows.

(1) DC type

Item	iXP70-TTA/DC	iXP80-TTA/DC	iXP90-TTA/DC
Display type	TFT LCD		
Screen size	26.4cm (10.4")	30.7cm (12.1")	38.1cm (15")
Display Resolution	800 x 600 pixel (SVGA)	800 x 600 pixel (SVGA)	1,024 x 768 pixel (XGA)
Color indication	16-bit and 24-bit Color (default: 16-bit Color)		
Indication degree	Left/Right: 80 deg. Upper: 60 deg. Lower: 80 deg.	Left/Right: 80 deg. Upper: 60 deg. Lower: 80 deg.	Left/Right: 80 deg. Upper: 60 deg. Lower: 80 deg.
Backlight	LED Type		
Backlight duration	60,000 hours		
Brightness	700cd/m ²	550cd/m ²	800cd/m ²
Touch panel	4 – Line type, analog		
Sound Output	Magnetic buzzer (85dB)		
Audio Output	1 channel, stereo audio output		
Process	ARM Cortex-A8 Core (32bit RISC), 1GHz		
Memory	Flash	1GB(display 128MB)	
	Operating RAM	512MB	
	Backup RAM	1MB	
Backup data	Date/Hour data, Logging/Alarm/Recipe data and nonvolatile device		
Battery duration	Approx. 3 years (Operating ambient temperature of 25°C)		
Ethernet	1 channel, IEEE802.1a, 10Base-T/100Base-TX		
USB Host	3 channels, USB 2.0 host (mouse, keyboard, printer and USB memory driver is available) 1 channel, USB 2.0 slave (for download and upload project file)		
RS-232C	1 channel		

Chapter 3. Standard Specification

Item	iXP70-TTA/DC	iXP80-TTA/DC	iXP90-TTA/DC
RS-422/485	1 channel,RS-422/485 mode		
CF Card	1 Slot (Compact Flash)		
SD Card	1 Slot (SDHC)		
Human sensor	Detection range: side 1-1.5m, front 40-50cm Angle: high/low 100°, left/right 140° (detecting 5-20 micron infrared light)		
Audio output	LINE-OUT 1 channel		
Audio input	1 channel audio input (MIC/LINE-IN) → support only for multimedia type		
Video output	1 channel video output (RGB output) → support only for multimedia type		
Video input	1 channel video input (NTSC/PAL/SECAM) → support only for multimedia type		
Expansion module	For communication and I/O option module (available later)		
VM module	4 channels video input (available later)		
Multi-language	Up to 8 language simultaneously		
Animation	GIF format is available		
Recipe	available		
Data logging	available		
Script executor	available		
Certifications	CE, UL(cUL), KC		
Protection standard	IP65		
Dimension (mm)	270.5 x 212.5 x 60.0	313.0 x 239.0 x 56.0	395.0 x 294.0 x 60.0
Panel cut (mm)	259.0 x 201.0	301.5 x 227.5	383.5 x 282.5
Rated voltage	DC12/24V		
Power consumption (W)	42	42	42
Weight(Kg)	2.2	2.4	3.9

(2) AC type

Item	iXP70-TTA/AC	iXP80-TTA/AC	iXP90-TTA/AC
Display type	TFT LCD		
Screen size	26.4cm (10.4")	30.7 cm(12.1")	38.1cm(15")
Display Resolution	800 x 600 pixel (SVGA)	800 x 600 pixel (SVGA)	1,024 x 768 pixel (XGA)
Color indication	16-bit and 24-bit Color (default: 16-bit Color)		
Indication degree	Left/Right: 80 deg. Upper: 60 deg. Lower: 80 deg.	Left/Right: 80 deg. Upper: 60 deg. Lower: 80 deg.	Left/Right: 80 deg. Upper: 60 deg. Lower: 80 deg.
Backlight	LED Type (replaceable)		
Backlight duration	60,000 hours		
Brightness	700cd/m ²	550cd/m ²	800cd/m ²

Chapter 3. Standard Specification

Item	iXP70-TTA/AC	iXP80-TTA/AC	iXP90-TTA/AC
Touch panel	4 – Line type, analog		
Sound Output	Magnetic buzzer (85dB)		
Audio Output	1 channel, stereo audio output		
Process	ARM Cortex-A8 Core (32bit RISC), 1GHz		
Memory	Flash	1GB(display 128MB)	
	Operating RAM	512MB	
	Backup RAM	1MB	
Backup data	Date/Hour data, Logging/Alarm/Recipe data and nonvolatile device		
Battery duration	Approx. 3 years (Operating ambient temperature of 25℃)		
Ethernet	1 channel, IEEE802.1a, 10Base-T/100Base-TX		
USB Host	3 channels, USB 2.0 host (mouse, keyboard, printer and USB memory driver is available) 1 channel, USB 2.0 slave (for download and upload project file)		
RS-232C	1 channel		
RS-422/485	1 channel,RS-422/485 mode		
CF Card	1 Slot (Compact Flash)		
SD Card	1 Slot (SDHC)		
Human sensor	Detection range: side 1-1.5m, front 40-50cm Angle: high/low 100°, left/right 140° (detecting 5-20 micron infrared light)		
Audio output	LINE-OUT 1 channel		
Audio input	1 channel audio input (MIC/LINE-IN) → support only for multimedia type		
Video output	1 channel video output (RGB output) → support only for multimedia type		
Video input	1 channel video input (NTSC/PAL/SECAM) → support only for multimedia type		
Expansion module	For communication and I/O option module (available later)		
VM module	4 channels video input (available later)		
Multi-language	Up to 8 language simultaneously		
Animation	GIF format is available		
Recipe	available		
Data logging	available		
Script executor	available		
Certifications	CE, UL(cUL), KC		
Protection standard	IP65		
Dimension (mm)	270.5 x 212.5 x 60.0	313.0 x 239.0 x 56.0	395.0 x 294.0 x 60.0
Panel cut (mm)	259.0 x 201.0	301.5 x 227.5	383.5 x 282.5
Rated voltage	AC 100-240V		
Power consumption (W)	42	42	42
Weight(Kg)	2.2	2.4	3.9

Note

- (1) Caution in power connection
: With AC power applied to DC power device, it may cause product damage or fire.
Please pay a special attention to connection.
- (2) FG Connection
: For the device FG, please use ⑤ FG terminal in the Chapter 2.1, which is FG terminal for extended FG card.
- (3) Battery discharge-preventing tape and DIP switch
: Tape is attached to prevent battery discharge. To use backup function, please remove the tape and turn on DIP switch No. 3.
- (4) Battery Operation and Life
: Battery is used for backup data maintenance and RTC (date/time) when the power of device is off. It is used only when power is Off. Battery is not consumed with power applied. If battery is discharged, Super-Cap is used for 8 days for backup data maintenance and RTC (date/time) with power off
- (5) LCD Backlight Replacement
: Please replace LCD if you want to replace LCD backlight.
- (6) Caution in Audio Output
: Unamplified speaker without the volume adjustment function such as earphone, headset, etc. may make a small sound output through LINE-OUT.



Chapter 4. System Configuration

It describes the system configuration including XGT Panel's time setting, Ethernet connection setting, and connection with PC and backlight.

If you press [Settings] button in XGT Panel's basic screen, you can set XGT Panel's environment as follows.

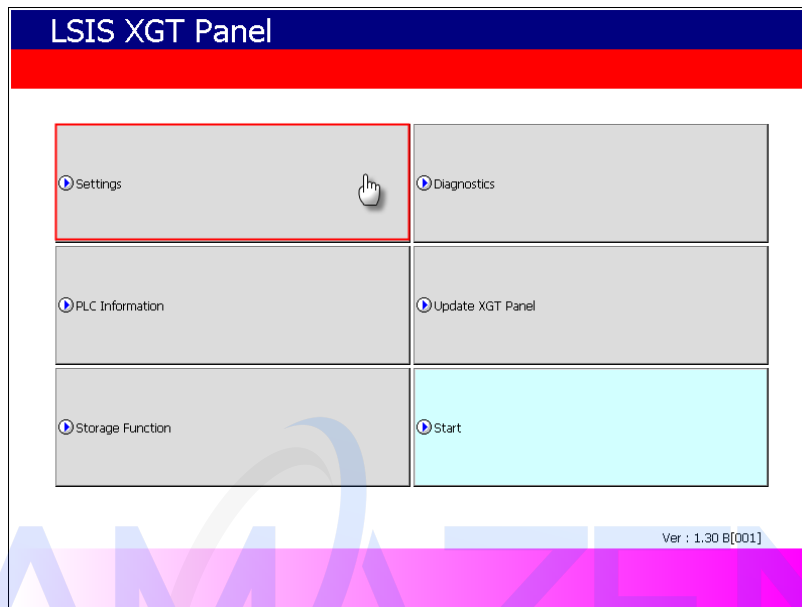

Main screen

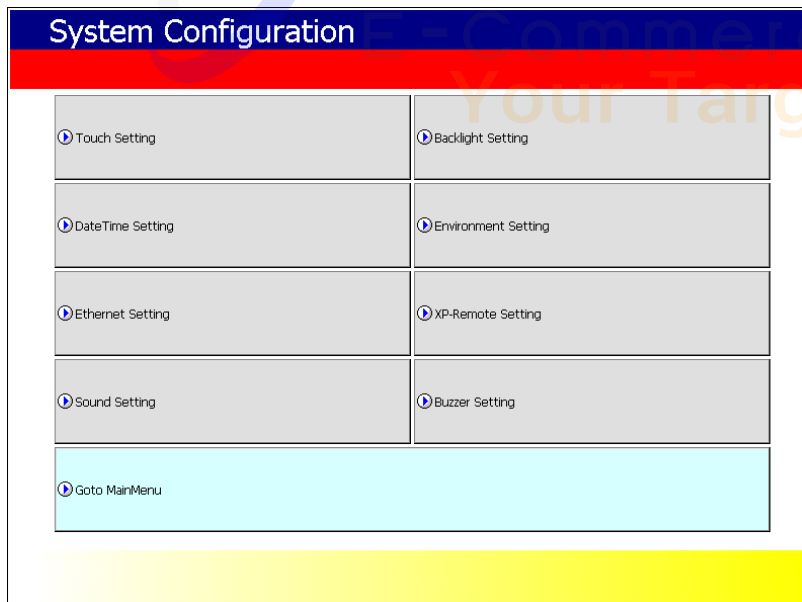

System Configuration screen

Chapter 4. System Configuration

4.1 Touch Calibration

When the location is not recognized in XGT Panel, Touch's scale can be adjusted in XGT Panel. If you press [Touch Calibration] button in System Setting, the setting screen shows up. If you press five '+' marks, XGT Panel's touch location adjustment is completed.

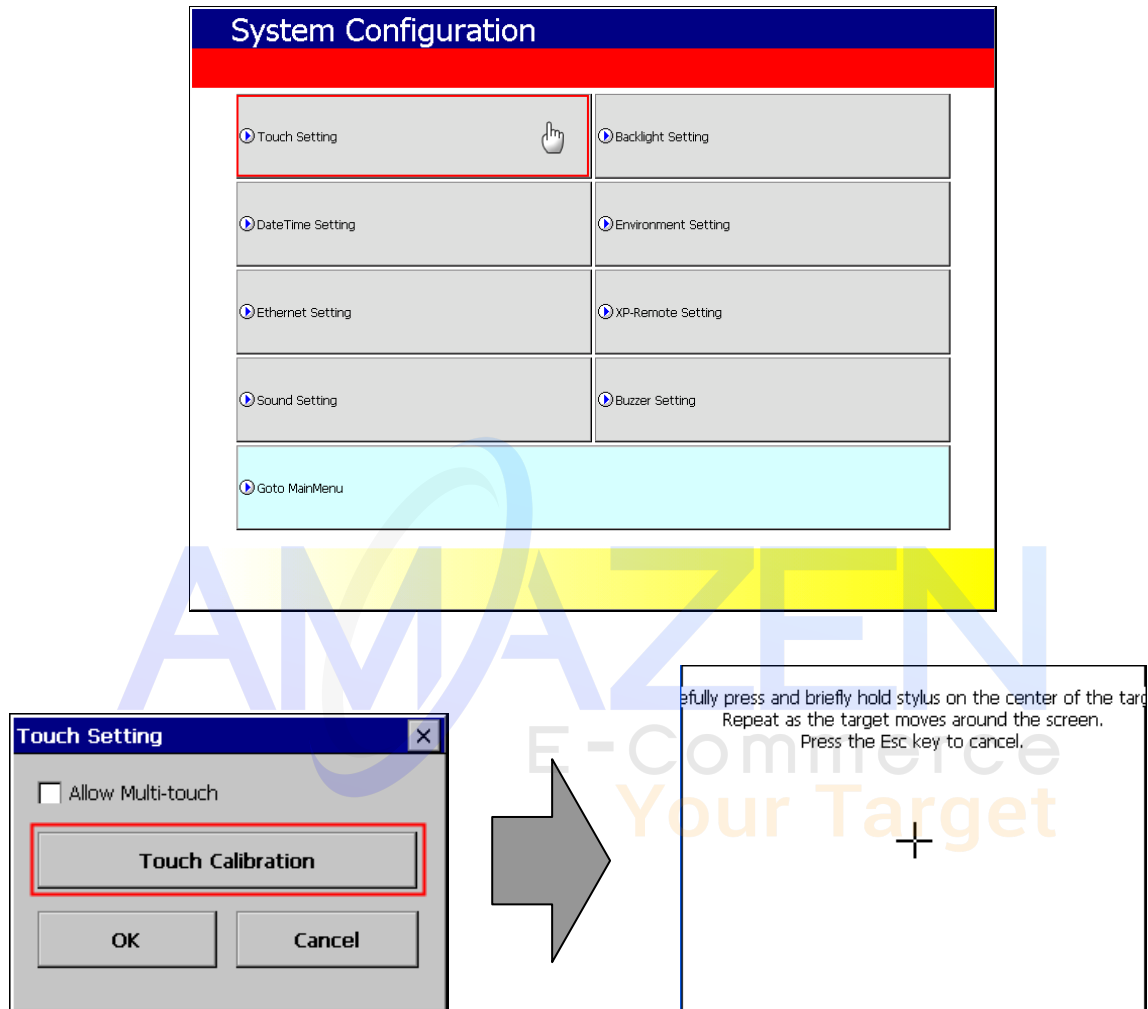

If you press two points simultaneously while [Allow Multi-touch] is selected, XGT Panel recognizes as if middle point between two points is selected. If you press two points simultaneously while [Allow Multi-touch] is not selected, XGT Panel recognizes as if any point is not selected.

Remark

- (1) XGT Panel's Touch Calibration setting is basically set. If Touch location is way off, adjusting menu with touch can be hard through touch. In that case, You can select the Touch Calibration setting menu by USB mouse or simply touch 5 times at the empty space on the main screen.
- (2) When touch location changes in using, redo touch setting.
- (3) If you don't allow Multi-touch, sensitivity is lower than when allowing Multi-touch.

4.2 Backlight Setting

If you press [Backlight Setting] button in [System Configuration] screen as follows, setting screen shows up.

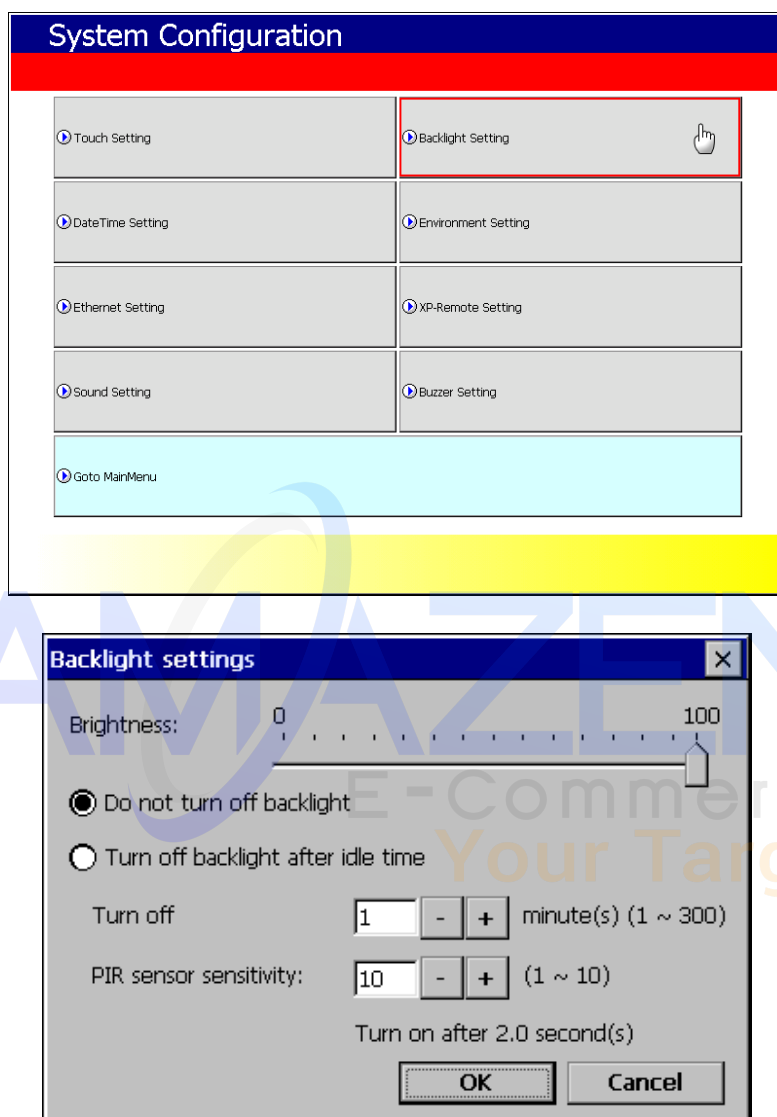

[Dialog box explanation]

Name	Explanation
Brightness	It may adjust brightness of backlight.
Do not turn off backlight	It doesn't turn off backlight power.
Turn off backlight after idle time	It automatically turns off backlight if not in touch for a certain period of time.
Turn off ~ minutes	It turns off backlight after a designated time (unit of minute).
PIR sensor sensitivity	Set the sensitivity level for the PIR (Passive Infrared) sensor. The lower the value, the quicker the backlight will turn on. When set to the lowest value, the backlight will turn on immediately when the screen is touched.

Chapter 4. System Configuration

4.2.1 PIR sensor

The XGT Panel's backlight is activated by detecting movement around the XGT Panel. If you approach the XGT Panel when the display is off, movement around the XGT Panel from the left, right or front, is detected and turns on the backlight.

- (1) The XGT Panel has a detection range of 1-1.5m from both sides.



- (2) The XGT Panel has a detection range of 40-50cm from the front.



Remark

The detection distance may vary depending on temperature and location.

4.3 Date Time Setting

If you press [Date Time Setting] button in [System Configuration] as follows, you can set XGT Panel's data and time.

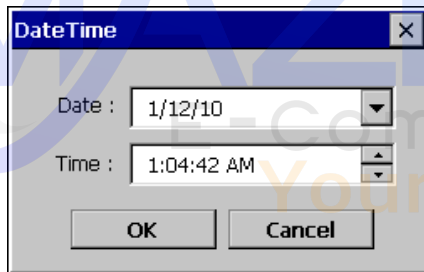
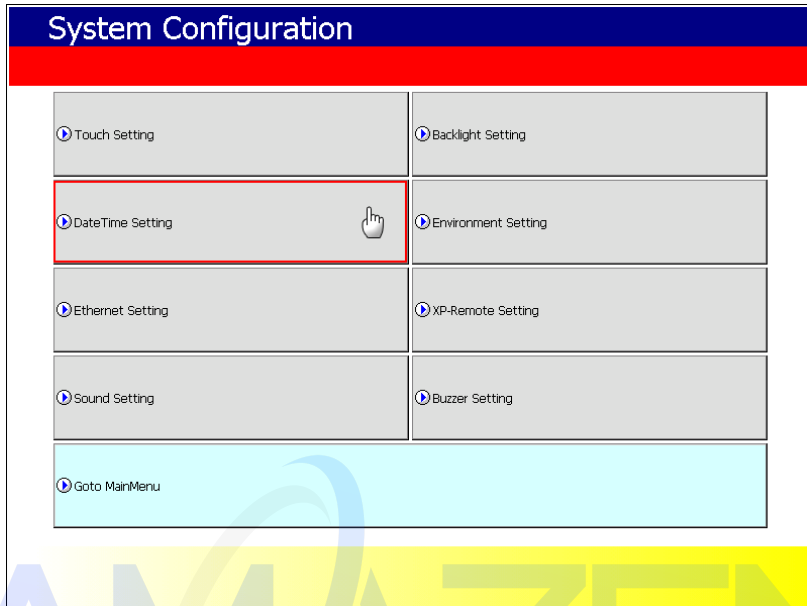

Remark

You can set data/time at device information of communication dialog at the XP-Builder.
For details, please refer to the XP-Builder's manual.

Chapter 4. System Configuration

4.4 Ethernet Setting

If you press [Ethernet Setting] button in [System Configuration] screen as follows, you can change IP to use Ethernet.

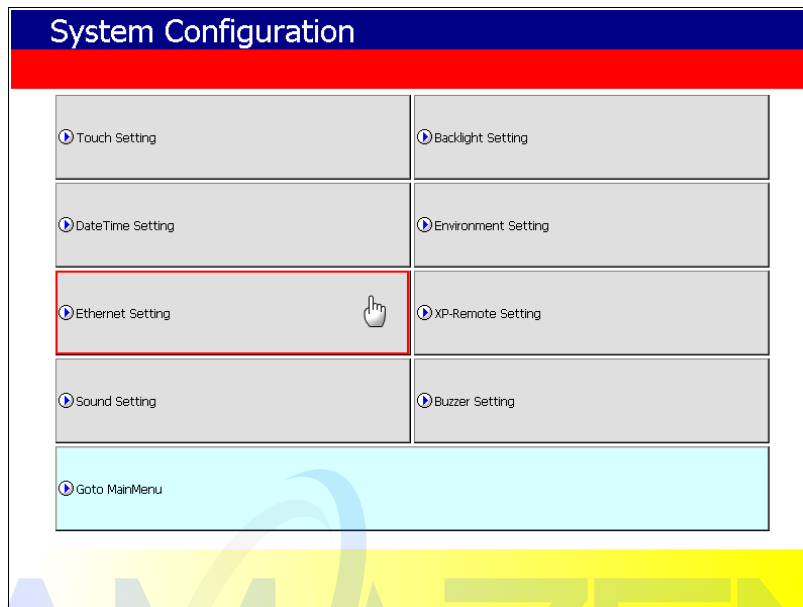

You can change IP address by pressing [Set] button of each IP address, Subnet Mask and Gateway. By pressing OK button, changed IP information is reserved.

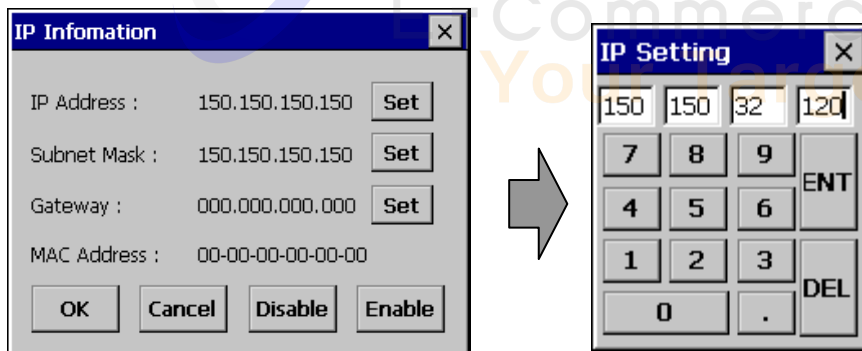

Remark

We recommend the following method, when connecting with PC solely.

- | | |
|------------------------------|------------------------------|
| 1) XGT Panel setting | 2) PC setting |
| - IP Address : 192.168.0.10 | - IP Address : 192.168.0.11 |
| - Subnet Mask: 255.255.255.0 | - Subnet Mask: 255.255.255.0 |
| - Gateway : 192.168.0.1 | - Gateway : 192.168.0.1 |

If you reboot after pressing [Disable] button, the device will not use Ethernet. In this case, booting speed gets faster. If you use Ethernet again, reboot after pressing [Enable].

4.5 Environment Setting

If you press [Environment Setting] button in [System Configuration] screen as follows, you can set 'Auto Goto Screen' and 'Buzzer On/Off'.

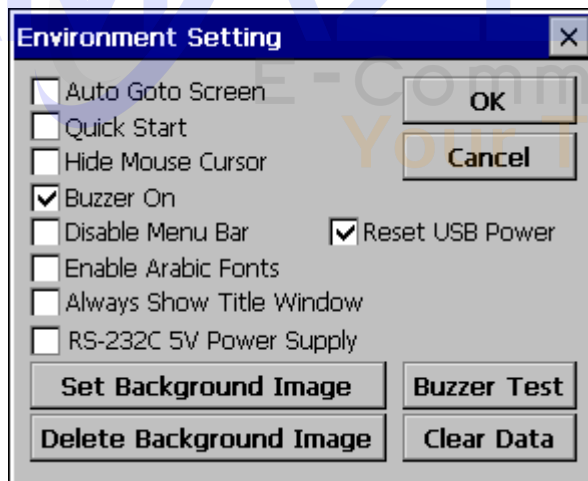
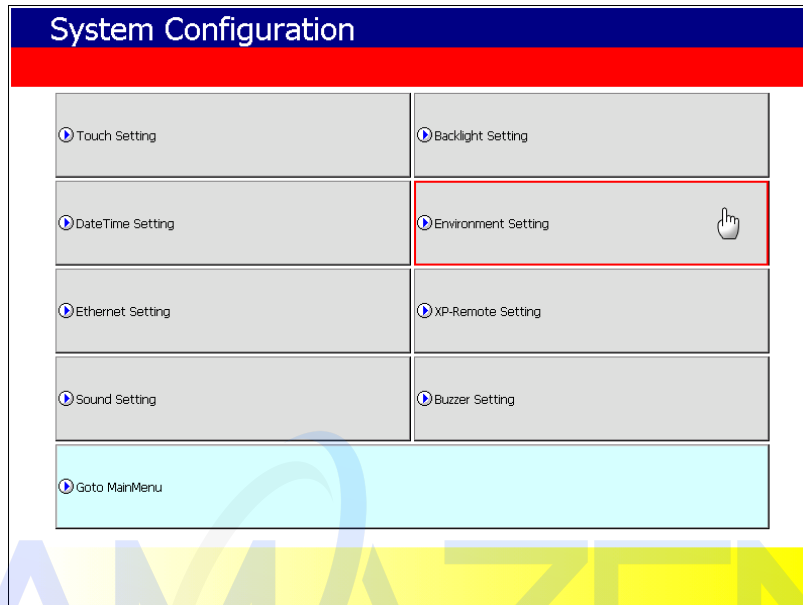

Name	Explanation
Auto Goto Screen	When setting [Auto Goto Screen], XGT Panel is rebooted. Or when downloading the edit data is completed, the screen automatically shows up. If you cancel this setting, the user should press 'Start' button in order to move to the screen.
Quick Start	When starting screen, screen shows promptly without showing progress bar because it doesn't caching the image in advance. However, if you select this option, first screen shows slowly. Especially, if there are many animation objects in screen, it may take several seconds based on image. But fast screen switching is available since second screen switching.

Chapter 4. System Configuration

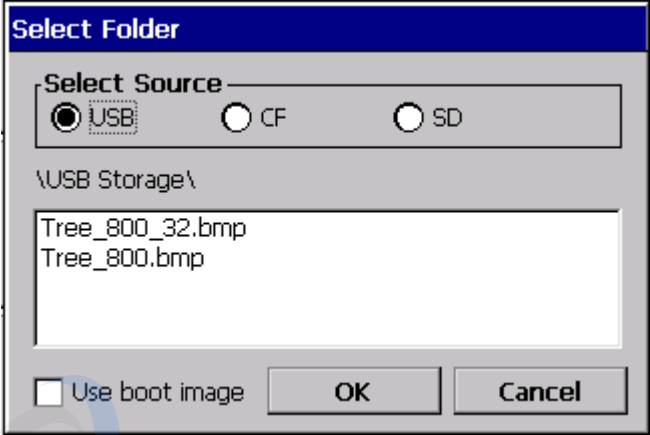
Hide Mouse Cursor	Mouse cursor doesn't show after screen switching
Buzzer On	You can set whether you use buzzer through [Buzzer On/Off] button.
Disable Menu Bar	The menu bar basically provided to go out from monitoring screen to the waiting screen doesn't show. In this case, if you want to go out to the waiting screen, you have to use the special switch to close the monitoring screen.
Set Background Image	<p>If you select the image through [Set Background Image], background image of waiting screen is set as the selected image. If you want to cancel, press [Delete Background Image]</p>  <p>[Background Image Selection Screen]</p> <p>[Use boot image] With an option selected, you cannot use it unless it is the image of different resolution from that of XGT Panel or 32-bit image.</p>
Clear Data	All files downloaded by the user are deleted. If connection password is set, you have to input the password. This password is connection password needed for project download, etc. You can set that password in [Communication] → [XGT Panel Information] → [Password] tap. The deleted files are user project file, web server, VNC start module, option card driver, RAPIEnet communication setting data, XP-manager setting data and etc. Setting through Environment Setting menu of device is not initialized.
Buzzer Test	It may test the buzzer.
Reset USB Power	When XGT Panel starts, USB power state is converted from Off to On initializing the connected device.
Enable Arabic Fonts	It enables the language indicated from right to left directions.
Always Show Title Window	It indicates title bar on pop up window. With title bar of pop up window selected, it may move the location.
RS-232C 5V Power Supply	When the monitor starts with XGT Panel button [Start] pushed, it outputs 5V power using No. 9 pin of RS-232C Port. When turning off XGT Panel monitor and returning to menu screen again, it stops power output.

Note

Buzzer can make settings in information on device tab of communication dialog box in the XP-Builder.
Please refer to the XP-Builder's manual.

4.6 Sound Setting

It may adjust XGT Panel sound volume.

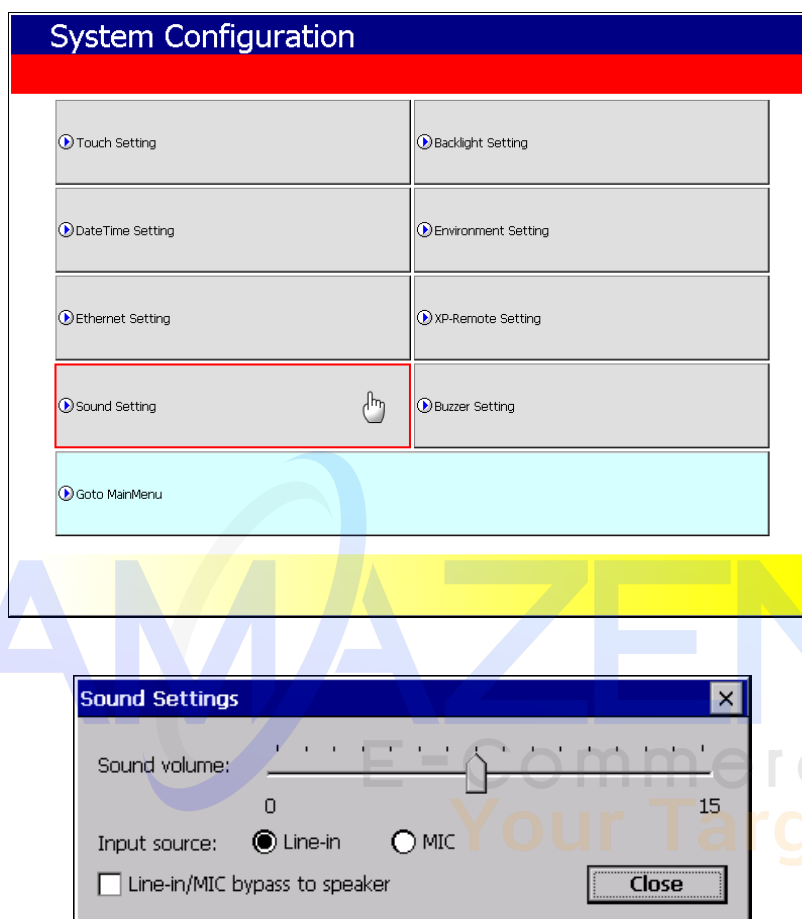

[Sound Setting Screen]

[Dialog box Explanation]

Name	Explanation
Sound volume	It may adjust sound output volume.
Input source	It designates the sound input type in Line-in or microphone. This function is supported in multimedia type XGT Panel only.
Line-in/MIC bypass to speaker	It transmits input sound (microphone, etc.) to the connected speaker. This function is supported in multimedia type XGT Panel only.

Note

In case of microphone with power not applied like ear microphone, it has no sound input function.
Unamplified speaker without volume adjustment function such as earphone, headset, etc. may make a small sound output through LINE-OUT

Chapter 4. System Configuration

4.7 XP-Remote Setting

Settings of XP-Remote that can remotely adjust XGT Panel can be changed.

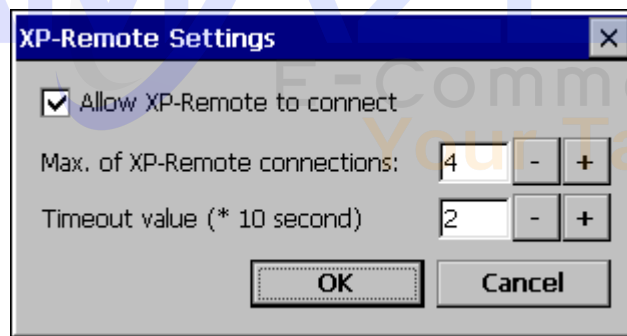
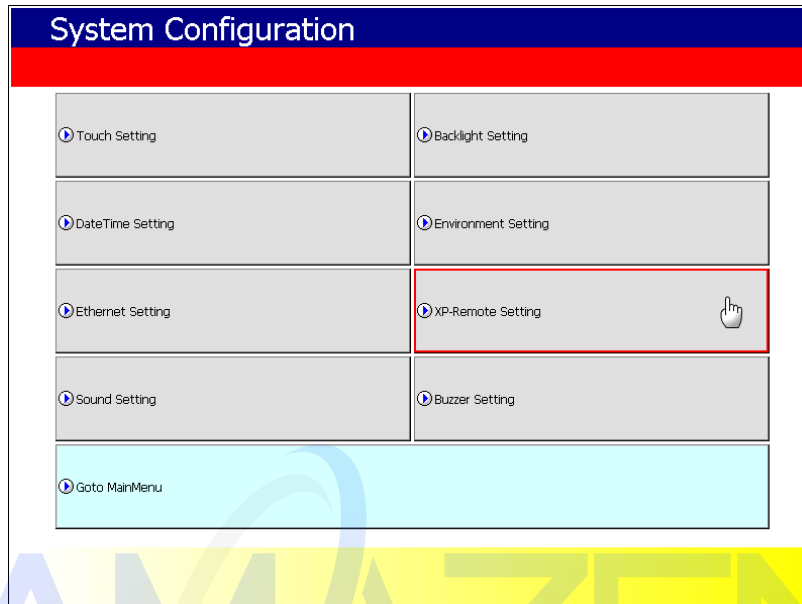

[XP-Remote Setting Screen]

[Explanation of dialog box]

Name	Explanation
Allow XP-Remote to connect	It allows connecting remote XP-Remote.
Max. of XP-Remote connections	It designates the maximum number of XP-Remote connected with XGT Panel.
Timeout value	It stops communication when there is no request of communication from XP-Remote within the designated time. In case XP-Remote is entitled to manipulation, it withdraws the right to manipulation (10 seconds ~ 300 seconds)

Note

For the function of XP-Remote in detail, please refer to XP-Remote user's manual.

4.8 Buzzer Setting

It may adjust volume and height of XGT Panel Buzzer.

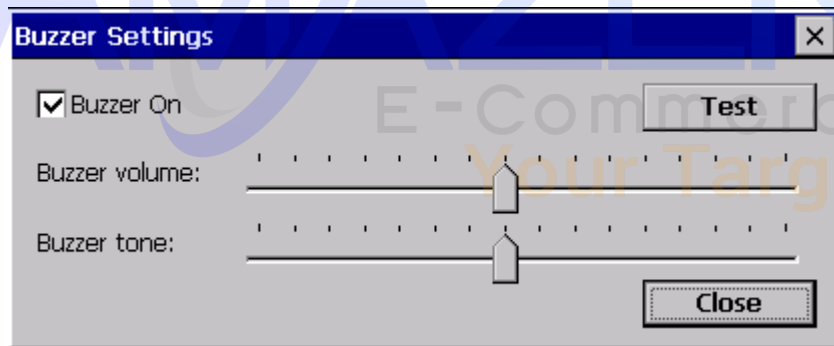
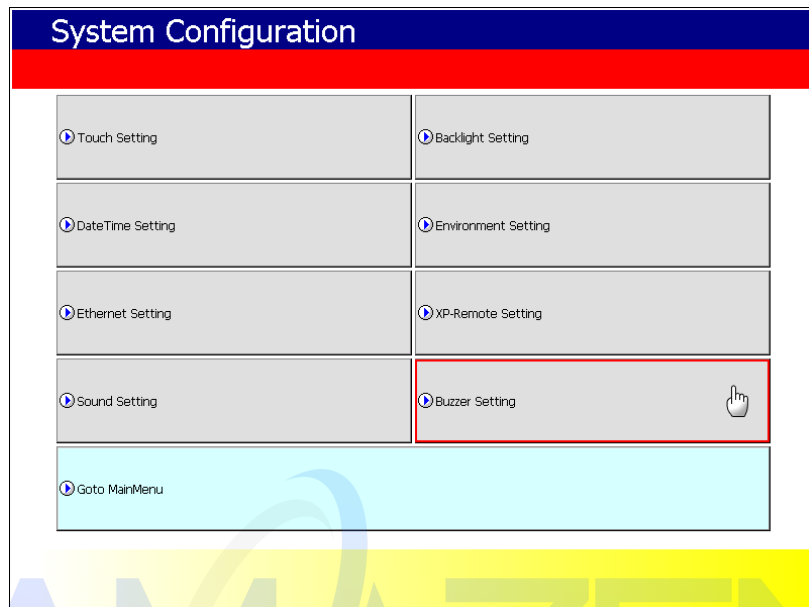

[Buzzer Settings Screen]

[Explanation of dialog box]

Name	Explanation
Buzzer On/Off	It may turn on or off the buzzer that occurs when in touch mode
Buzzer volume	It may adjust the volume of Buzzer
Buzzer tone	It may adjust the height of Buzzer.

Chapter 5. Diagnostics

It describes the diagnosis function for XGT Panel's communication terminal, screen and touch function.
 If you press [Diagnostics] button on the XGT Panel's basic screen, the menu for diagnosis shows up.

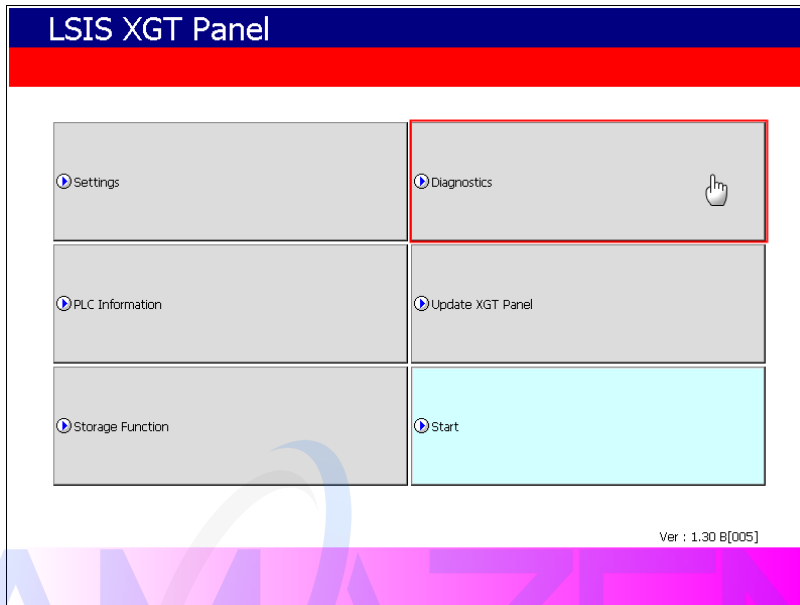

Main Screen

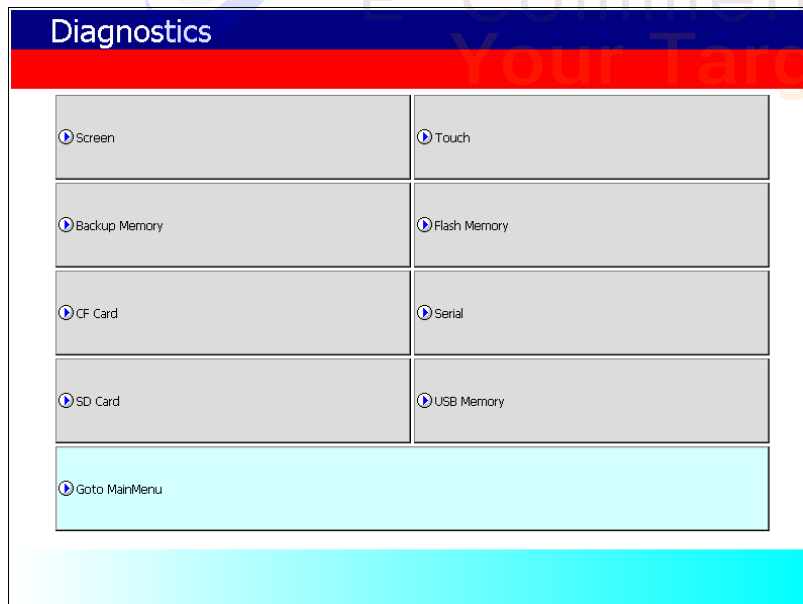

Environment setting screen

Chapter 5. Diagnostics

5.1 Screen Diagnosis

If you press [Screen] button, screens continuously change into diverse color with buzzer. For XP30-BTA/DC product, screen changes into 8 steps' light. After all screen for diagnosis pass. Then, Close button shows up with white ground.

If you press Close button, the initial screen shows up.

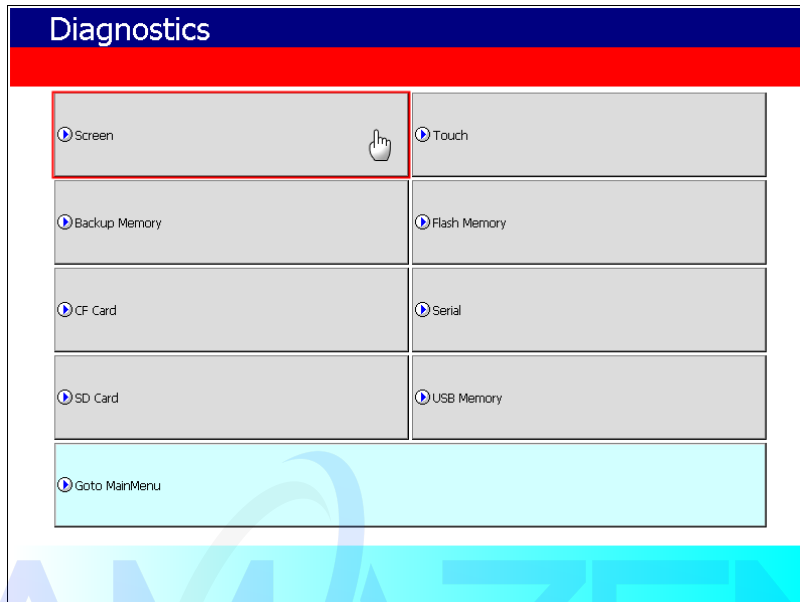

Diagnosis screen

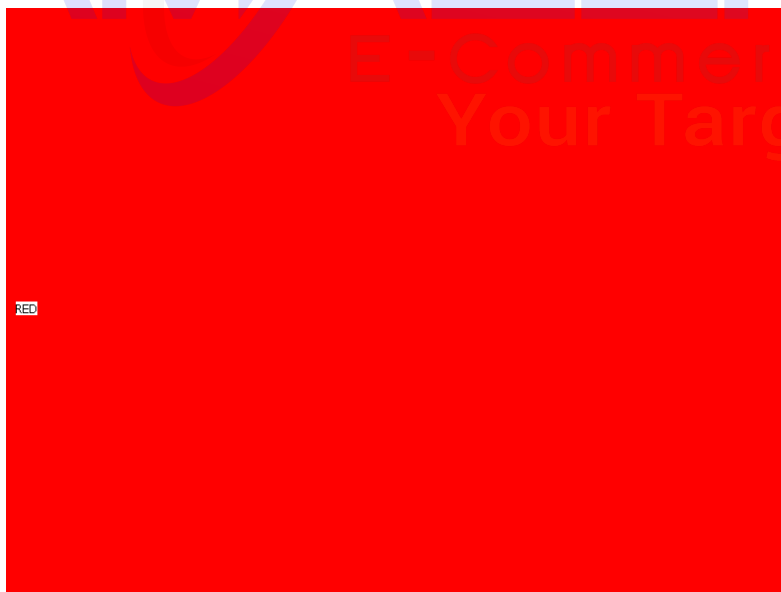

Screen diagnosis

Display Sequence	RED > GREEN > BLUE > BLACK > WHITE>GRAPH
-------------------------	--

5.2 Touch Diagnosis

If you touch the screen, the touched location is displayed as follows. If pressing the [OK] button, you can quit the screen.

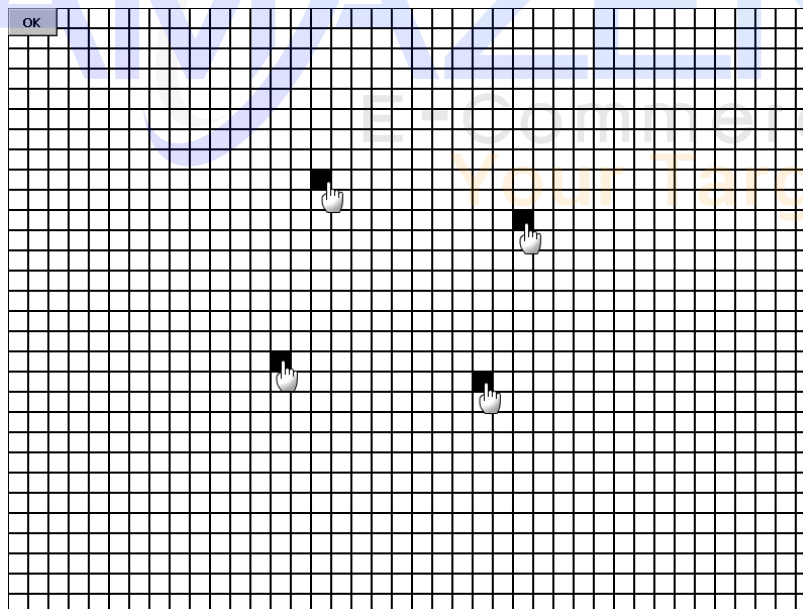
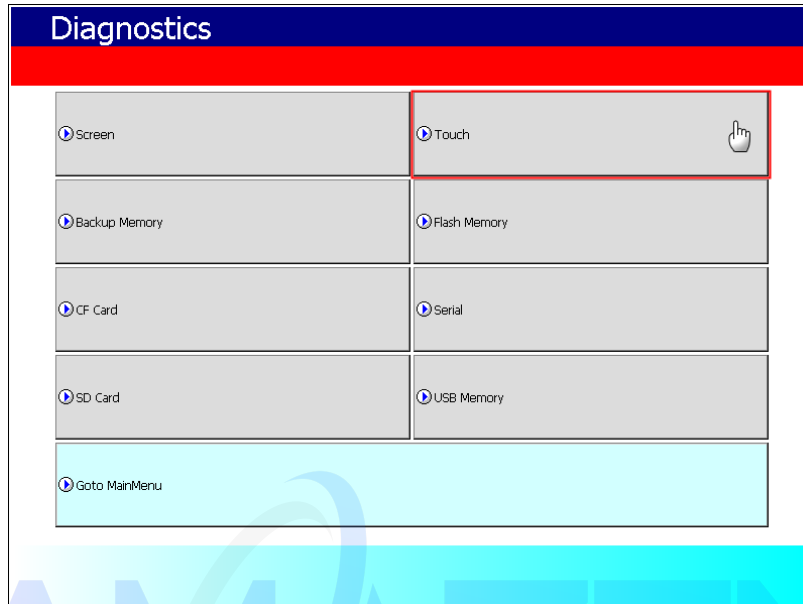

Touch diagnosis

If the touched location is not correct, reset the Touch setting. For detailed information, please refer to the Chapter 4. System Configuration.

5.3 Backup Memory Diagnosis

If you press [Backup Memory] button, you can see the result of diagnosis in the result windows.

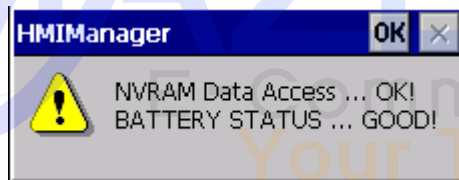
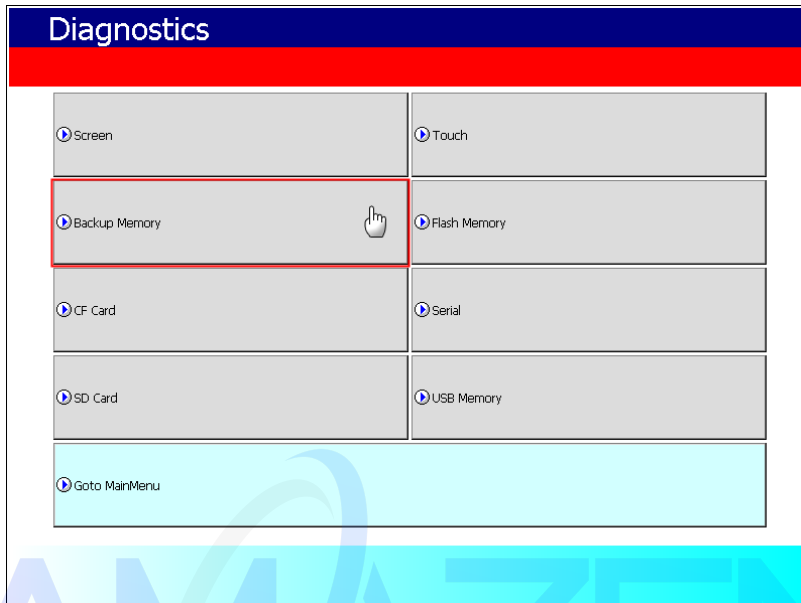

Completion of Backup Memory diagnosis

Remark

- (1) If 'NVRAM Data Access ... Fail' error is occurred, please contact with customer service center.
- (2) If 'BATTERY STATUS ... BAD' error is occurred, battery should be changed. Please contact with Customer service center.

5.4 Flash Memory Diagnosis Function

If you press [NOR Flash] button, you can see the result of diagnosis in the result widows.

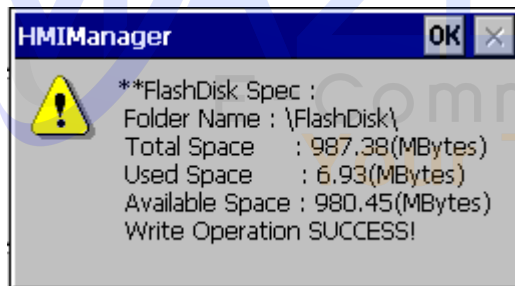
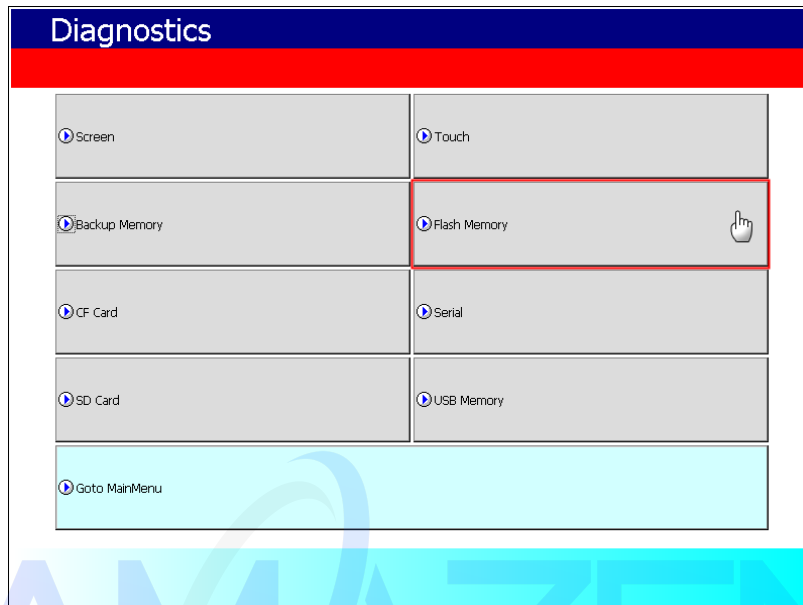

Completion of Flash Memory diagnosis

Remark

If 'Read Disk Information Error!' occurs, please contact with Customer service center.

Chapter 5. Diagnostics

5.5 CF Card Diagnosis

If you press [CF Card] button, the result of diagnosis shows up in the result windows.

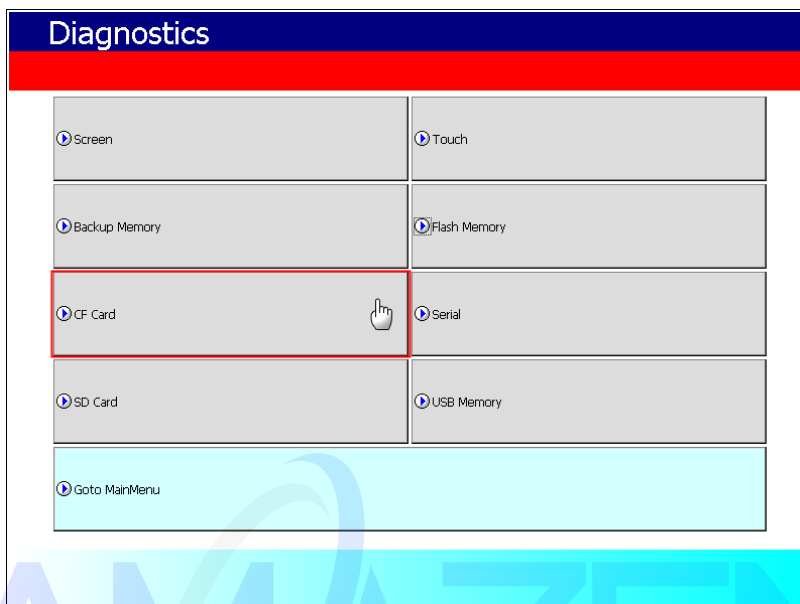

Completion of CF Card diagnosis

Remark

If 'Read Disk Information Error!' occurs, please contact with Customer service center.

5.6 Serial Communication Diagnosis

If you press [Serial] button, you can diagnose Serial ports which is equipped at XGT Panel.
(In case of diagnosis purpose, you have to connect the loop-back terminal at each port.)

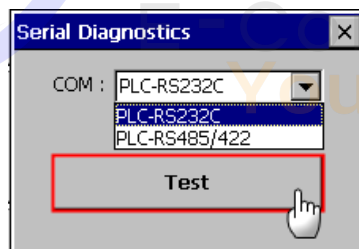
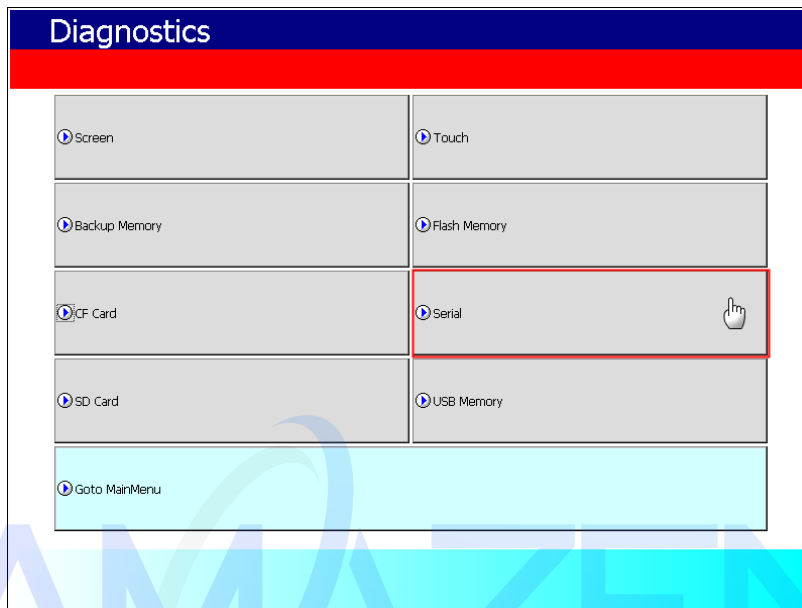

Serial port selection

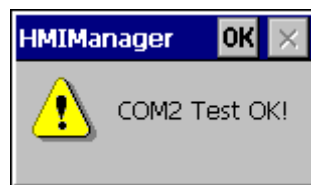

Completion of serial port diagnosis

Chapter 5. Diagnostics

The RS-232C port terminal should be made as follows

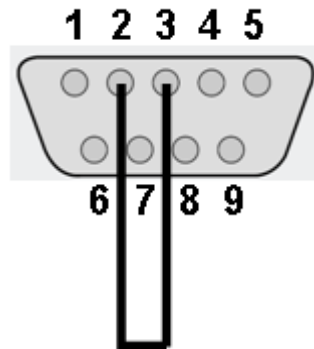

(Connect the No.2 and 3 pin)

The RS-422/485 port terminal should be made as follows.

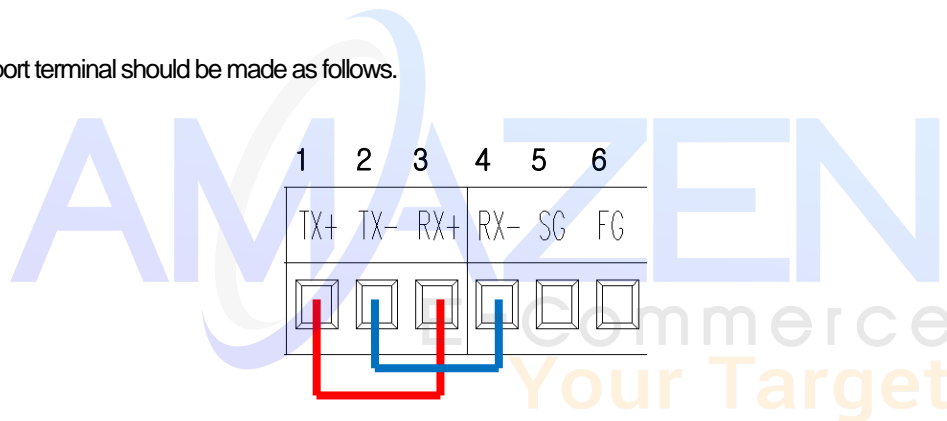

(Connect the TX+ with RX+ and TX- with RX-)

Pin	Name	Function
1	TX+	Transferring data
2	TX-	Transferring data
3	RX+	Receiving data
4	RX-	Receiving data
5	SG	Signal Ground
6	FG	Frame Ground

5.7 SD Card Diagnosis

If you press [SD Card] button, the result of diagnosis shows up in the result windows.

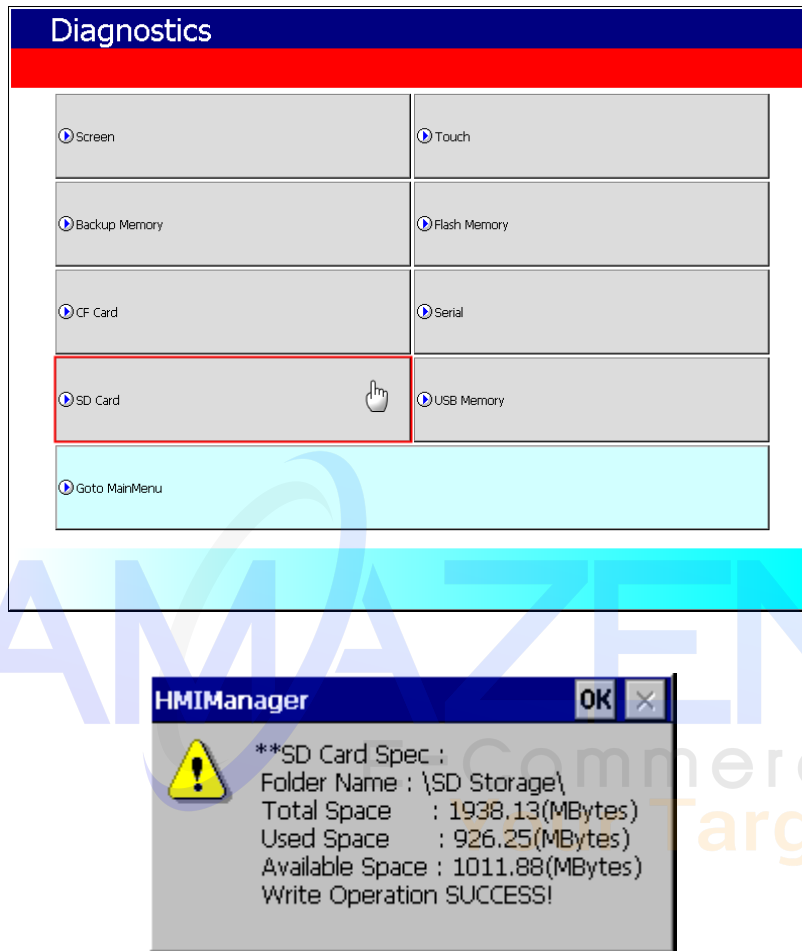

Completion of SD Card diagnosis

Remark

If 'Read Disk Information Error!' occurs, please contact with Customer service center.

Chapter 5. Diagnostics

5.8 USB Memory Diagnosis

If you press [USB Memory] button, the result of diagnosis shows up in the result windows.

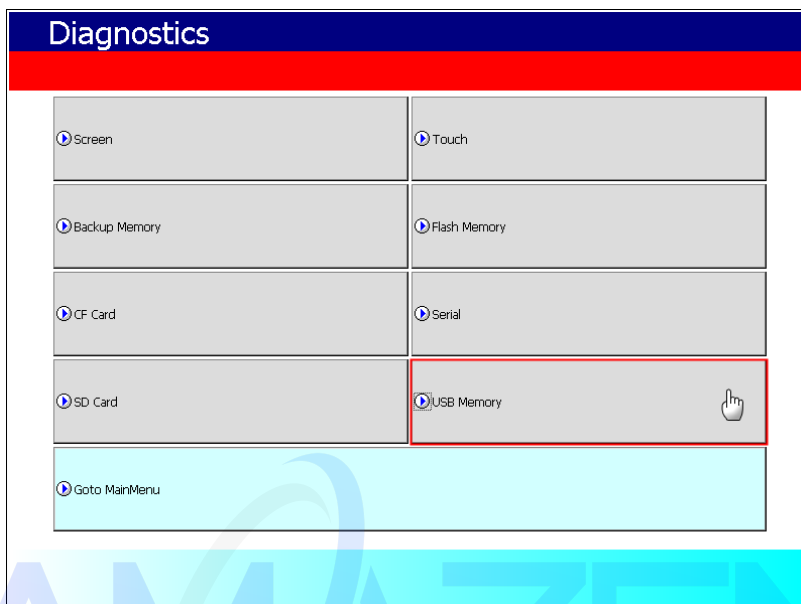

Completion of USB Memory diagnosis

Remark

If 'Read Disk Information Error!' occurs, please contact with Customer service center.

Chapter 6 Viewing Information of PLC Connection Status

PLC Information, it shows XGT Panel configuration, PLC CPU status and various records.

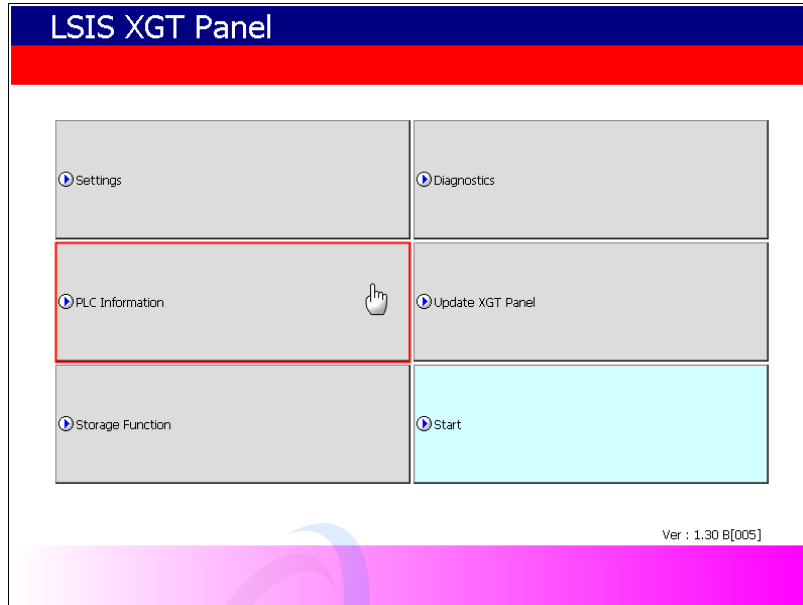

Remark

You can check the status of PLC connection after project data is transmitted into XGT Panel.

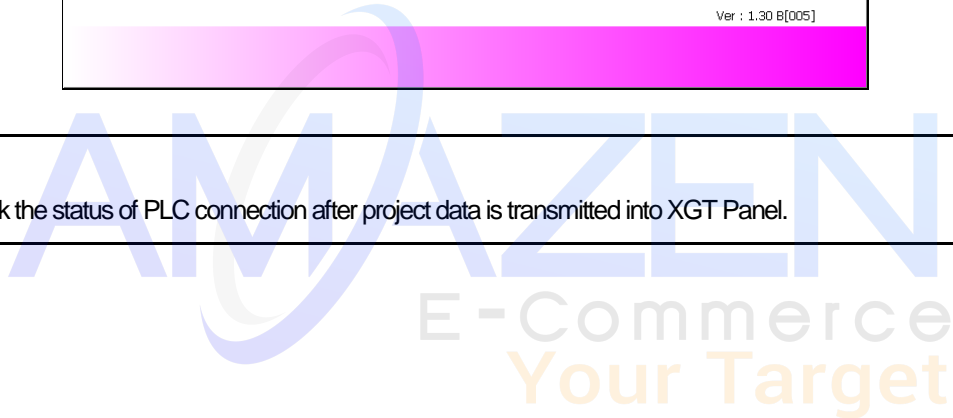

Ch.6 Viewing Information of PLC Connection Status

6.1 PLC Communication Configuration Settings

You can select [Settings] button to change PLC communication settings

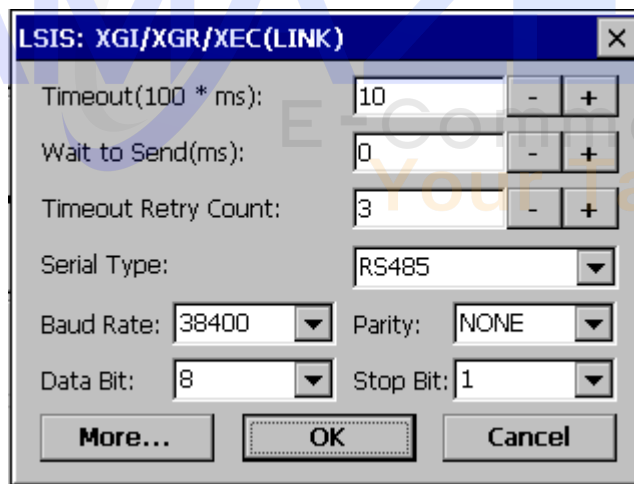
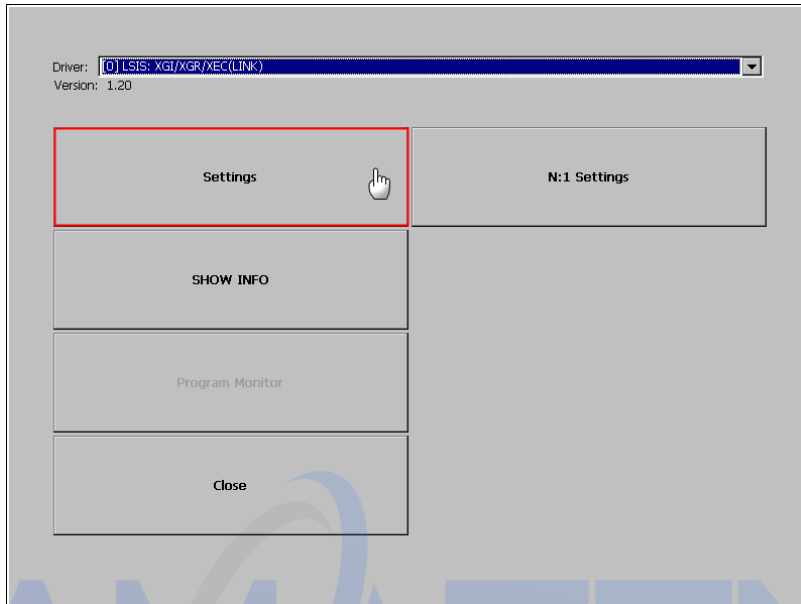

PLC Communication Configuration setting

Remark

- PLC Communication Configuration setting dialog box may look different.
- For further information about the settings, please refer to the PLC user manual.

6.2 Connection Information

You can check the setting items for the connection with PLC such as vender of PLC, target device, connection type, ip address, connection information and timeout value in the XP-Builder.

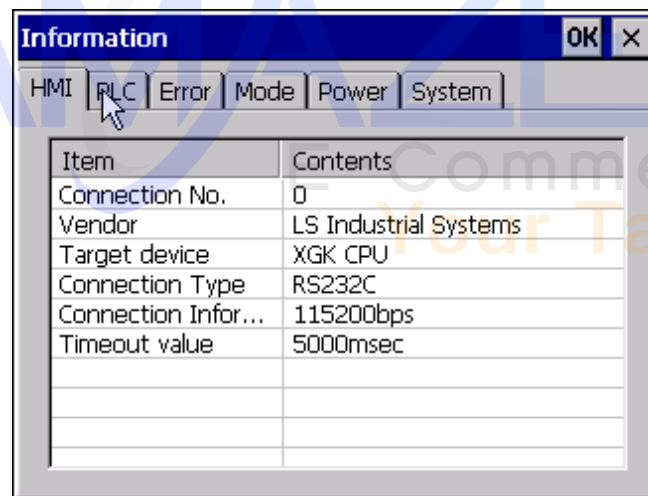
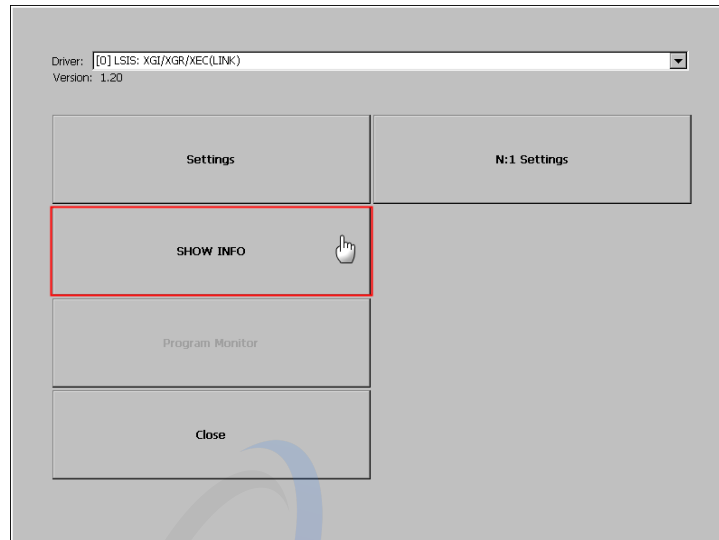

Remark

Connection No. → 0 to 15 connections can be made.

Ch.6 Viewing Information of PLC Connection Status

6.3 PLC Information

You can check CPU type of PLC, operation mode, state, version, and scan time.

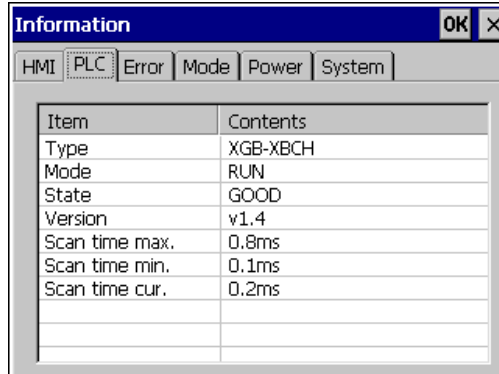

The screenshot shows a software window titled 'Information' with a blue header and 'OK' and 'X' buttons. Below the header are tabs for 'HMI', 'PLC', 'Error', 'Mode', 'Power', and 'System'. The 'PLC' tab is selected. The main area contains a table with two columns: 'Item' and 'Contents'.

Item	Contents
Type	XGB-XBCH
Mode	RUN
State	GOOD
Version	v1.4
Scan time max.	0.8ms
Scan time min.	0.1ms
Scan time cur.	0.2ms

Remark

The following PLC is available for view of PLC information.

- MASTER-K CPU, FEnet, Cnet
- GLOFA-GM CPU, FEnet, Cnet
- XGK/XGB/XGI/XGR CPU, FEnet, Cnet

6.4 History of PLC Error

You can check the PLC Error History.

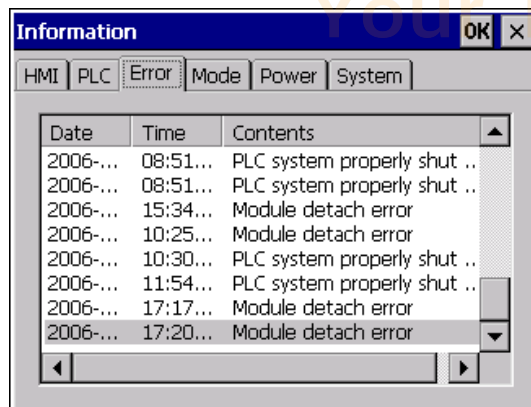

The screenshot shows the same 'Information' dialog box as in section 6.3, but with the 'Error' tab selected. The main area contains a table with three columns: 'Date', 'Time', and 'Contents'. The table lists several error events.

Date	Time	Contents
2006-...	08:51...	PLC system properly shut ..
2006-...	08:51...	PLC system properly shut ..
2006-...	15:34...	Module detach error
2006-...	10:25...	Module detach error
2006-...	10:30...	PLC system properly shut ..
2006-...	11:54...	PLC system properly shut ..
2006-...	17:17...	Module detach error
2006-...	17:20...	Module detach error

Remark

The following PLC is available for viewing Error History.

- MASTER-K CPU doesn't have the Error History.
- GLOFA-GM CPU, FEnet, Cnet
- XGK/XGB/XGI/XGR CPU, FEnet, Cnet

6.5 History of PLC Mode Conversion

You can check the history about our PLC's RUN/STOP operation mode.

Date	Time	Contents
2006-...	14:23...	Remote,Stop
2006-...	14:23...	Remote,Run
2006-...	10:02...	Remote,Stop
2006-...	10:32...	Remote,Stop
2006-...	16:57...	Remote,Stop
2006-...	17:47...	Remote,Stop
2007-...	15:02...	Remote,Stop
2007-...	15:02...	Remote,Stop

Remark

- The following PLC is available for viewing PLC operation mode conversion history.
- MASTER-K CPU doesn't have the history about operation mode conversion.
 - GLOFA-GM CPU, FEnet, Cnet
 - XGK/XGB/XGI/XGR CPU, FEnet, Cnet

6.6 History of PLC Power

You can check the history about when PLC was turned on and off

Date	Time	Contents
2006-10-26	12:02:36	Main base,
2006-11-01	18:34:39	Main base,
2006-11-04	17:15:38	Main base,
2006-12-01	19:41:59	Main base,
2006-12-06	16:56:59	Main base,
2006-12-27	17:10:13	Main base,
2007-01-15	15:02:16	Main base,
2007-01-15	15:02:18	Main base,

Remark

- The following PLC is available for viewing the history of when our PLC was turned off and on.
- MASTER-K CPU doesn't have the history about when our PLC was turned on and off.
 - GLOFA-GM CPU, FEnet, Cnet
 - XGK/XGB/XGI/XGR CPU, FEnet, Cnet

Ch.6 Viewing Information of PLC Connection Status

6.7 History of PLC System

You can check history about PLC system.

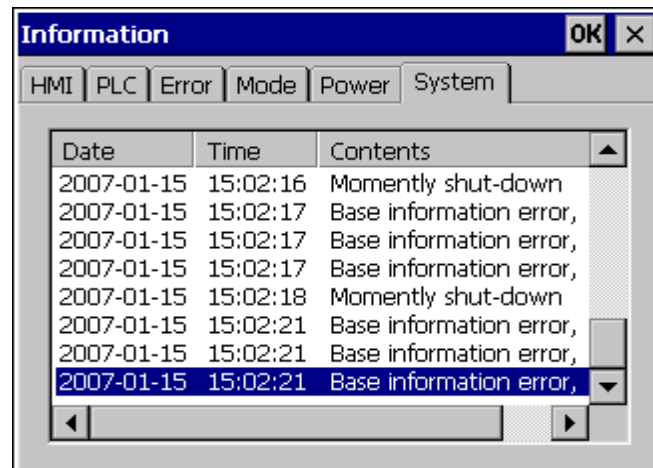

Remark

The following PLC is available for viewing history about system.

- MASTER-K CPU doesn't have the history about system.
- Only GLOFA-GM CPU (GM4C) has the history about system. Other CPUs don't have the history about system.
- XGK/XGB/XGI/XGR CPU, FEnet, Cnet

6.8 N:1 Settings

Using N:1 communication, it means communicate number of XGT Panel with single PLC.

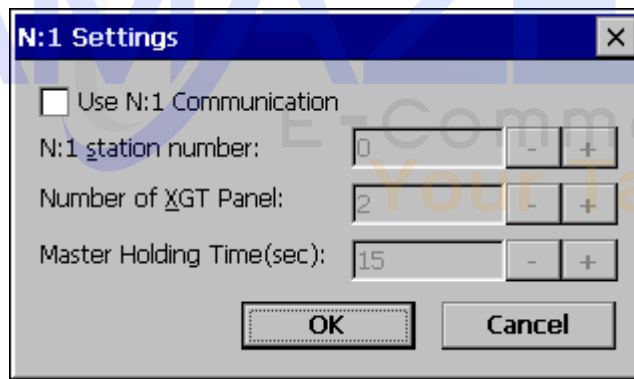
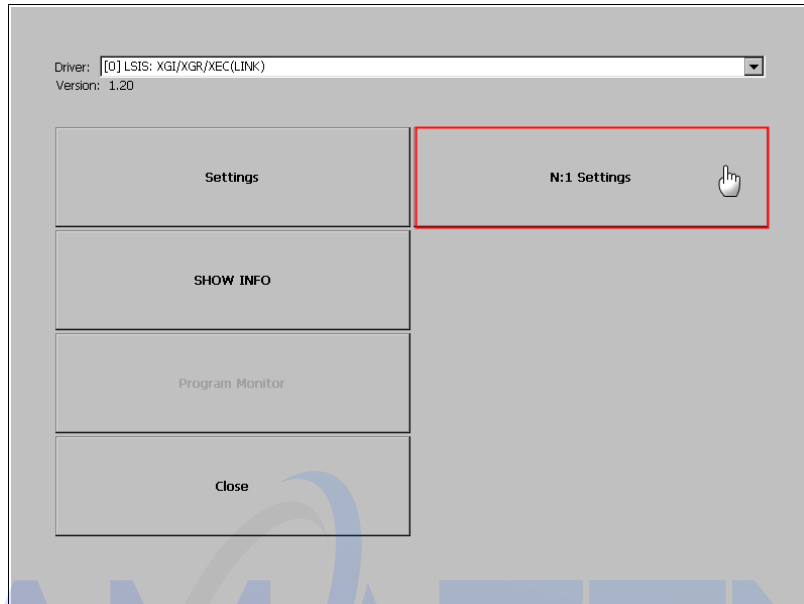

[N:1 settings dialog box]

Remark

For detail information about the N:1 communication, please refer to the XP-Builder manual.

6.9 Program Monitor

The programs that adopt LD language of XGK and XGB series can be monitored.

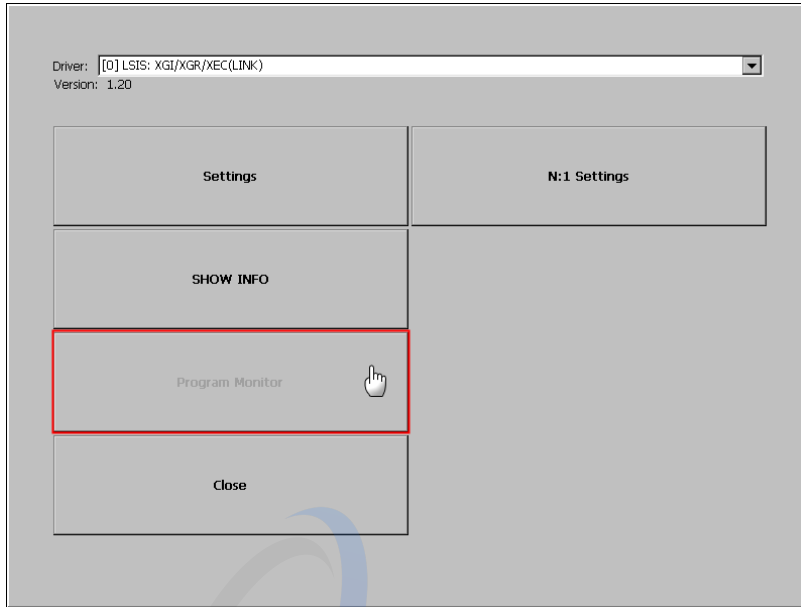

Remark

- Program Monitor driver can be downloaded from XP-Manager
- Only support for XGK/XGB CPU, Cnet, Enet communication
- To enable the [Program Monitor] button, program monitor should be checked in which locates in the XP-Builder project property menu.

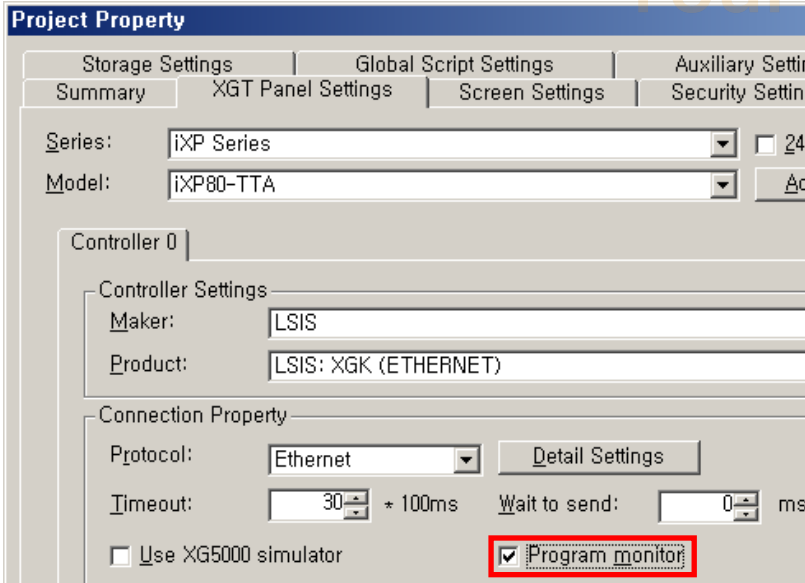

Chapter 7 Storage Function

7.1 General Introduction

Downloading the user project made in XP-Builder from PC, uploading the project stored in the device to PC, updating the device and etc are available through connection with XGT Panel with Serial cable or Ethernet cable generally. However, when those connections are not available, you can use CF card, USB storage equipment

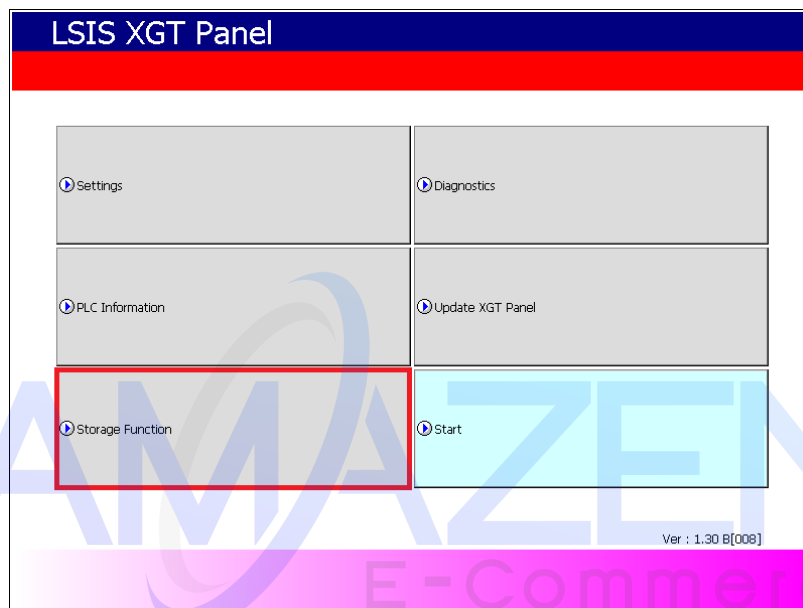

1. If you touch [Storage Function], the following dialog box shows.

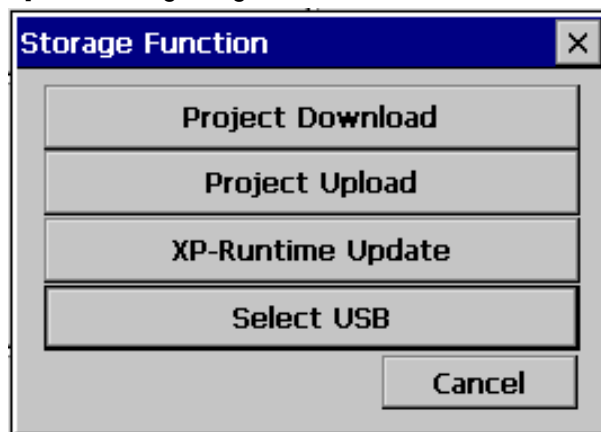

2. In case of downloading the project by using CF card or USB storage equipment, touch [Project Download] button.
3. In case of transmitting the project data stored in the device to CF card or USB storage equipment, touch [Project Upload] button.
4. In case of updating the XGT Panel with XGT Panel Software stored in CF card or USB Storage equipment, touch [XGT Panel Update]

7.2 Downloading Project through the Storage Equipment

1. If you touch [Project Download], the following dialog shows.

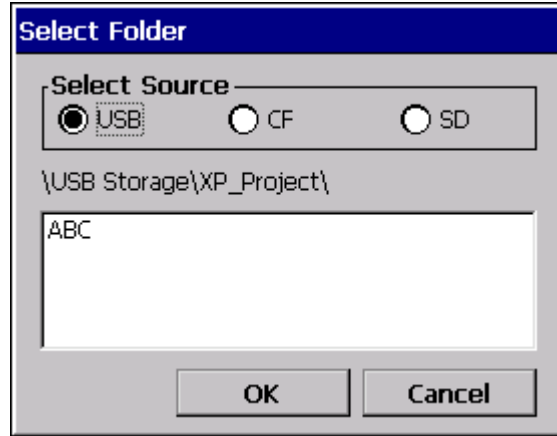

2. Please select the targeted external memory in "Select Source". Following path is indicated depending on the selected external memory.

- USB: \USB Storage\XP_Project\
- CF: \Storage Card\XP_Project\
- SD: \SD Storage\XP_Project\

In case of downloading the project by using storage equipment, the project should be saved in the one lower directory between those two directories.

3. Select one among directory lists and touch [OK].

4. Touch [OK] button, then download will start.

7.3 Uploading Project through the Storage Equipment

1. If you touch [Project Upload], the following dialog shows.

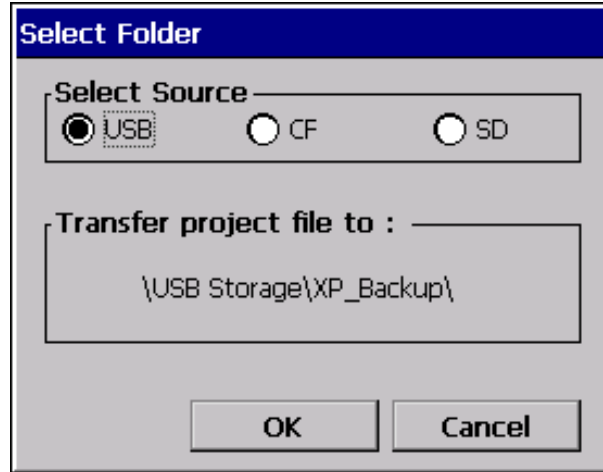

2. Please select the targeted external memory in "Select Source". Following path is indicated depending on the selected external memory

- USB: \\USB Storage\\XP_Backup\\
- CF: \\Storage Card\\XP_Backup\\
- SD: \\SD Storage\\XP_Backup\\

3. If you touch [OK] button, project backup file is transmitted to the selected path.

4. The project backup file is saved when Download project backup file is selected when downloading the project.

If you don't select, project backup file is not saved in the device and transmission to the storage equipment is not available.

7.4 Updating the Device through Storage Equipment

1. If you touch [Project Upload], the following dialog shows.

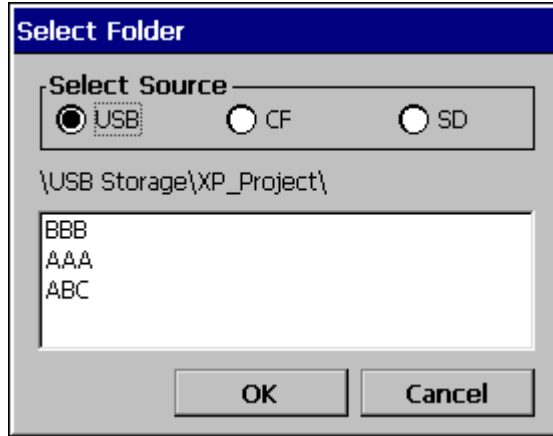

2. Please select the targeted external memory in "Select Source". Following path is indicated depending on the selected external memory

- USB: \USB Storage\XP_Software\
- CF: \Storage Card\XP_Software\
- SD: \SD Storage\XP_Software\

In case of updating the device by using storage equipment, the XGT Panel Software project should be saved in the one lower directory between those two directories.

3. If you touch [OK] button, the device is updated with XGT Panel Software in the designated path.

7.5 Select a USB Storage Device

1. When multiple USB devices are connected to the XGT Panel, you must select a device for uploading, downloading, or backing up projects. You can change your selection at any point during a project.

To select a USB storage device:

In the XGT Panel main menu, touch[Storage Function], then Touch [Select USB]

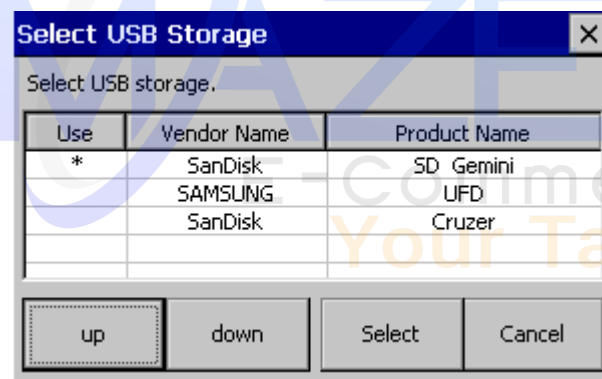
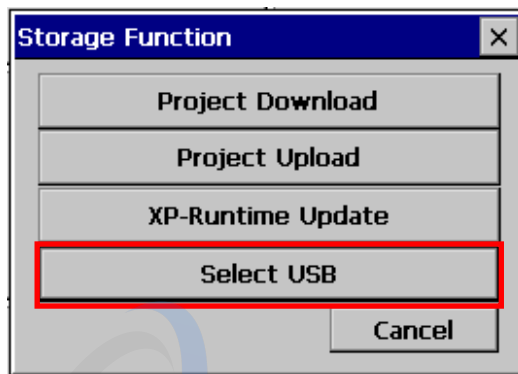

2. Select device from the list of connected devices

- Use: The selected device is indicated with an asterisk(*).
- Vendor Name: The device manufacturer
- Product Name: The device name
- Up/down: Move to the next or previous item
- Select: Save your selection
- Cancel: Exit without saving changes

7.6 Select USB Storage Device while Monitoring a Project

1. To select a storage device while monitoring a project, on the XGT Panel, touch [Start] to open the Select USB Storage window. Select a USB device and touch [Select].



2. To select a storage device from the status bar, touch [USB].



3. If the selected device is disconnected or if another device is connected, the Select USB Storage window appears again.

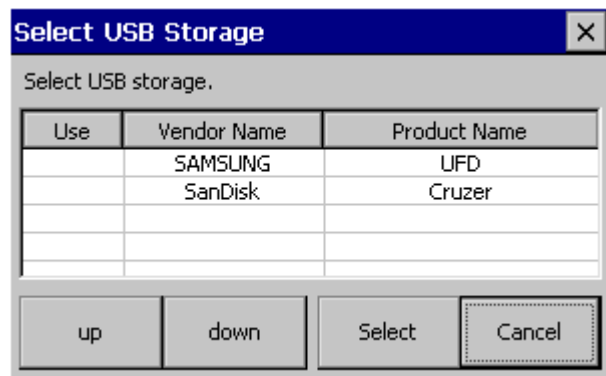

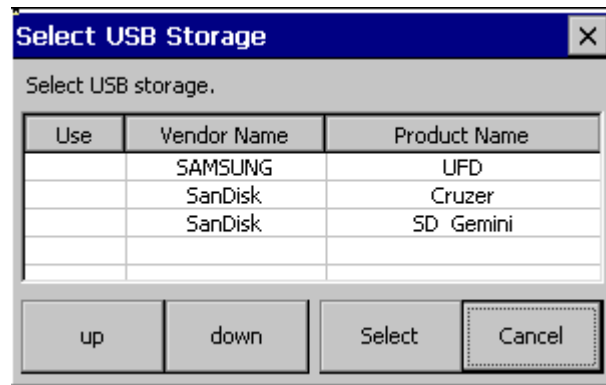
**Remark**

- (1) Do not remove or turn off the selected USB device while running a project. Project data may be corrupted and cause the project to malfunction.
- (2) Do not erase or move the directory or folders on the USB device. Doing so may cause data to be corrupted or the project to malfunction.
- (3) When removing an SD or CF storage device, turn on the safe removal switch on the back of the panel and remove the device only after the switch lamp turns off. Failure to do so may cause the device to be unrecognized when you reconnect it.
- (4) When you reconnect a device, allow at least three (3) seconds to establish the connection. Failure to do so may cause the device to be unrecognized when you reconnect it.
- (5) When one USB device is connected, turning on the power to the panel will set the USB device as the main storage device automatically.
- (6) When connecting multiple devices, the first device connected is set at the main storage device automatically. However, removing devices does not change the selected storage device automatically. You must reselect the main storage device.

Chapter 8 XGT Panel S/W Update

8.1 General Introduction

It describes the function for updating the XGT Panel software.

Basically you can optimize XGT Panel when you download the project file in XP-Builder. Please use this function only in case of updating XGT Panel specially.

New function is added to XGT software, you need to update a version of XGT Panel
Please refer to the following.

[Method]

Select [Upgrade -> Update XGT Panel] on the XGT Panel's main screen. Then XGT Panel becomes update mode. In order to return to the main screen, touch a screen for 3 seconds.

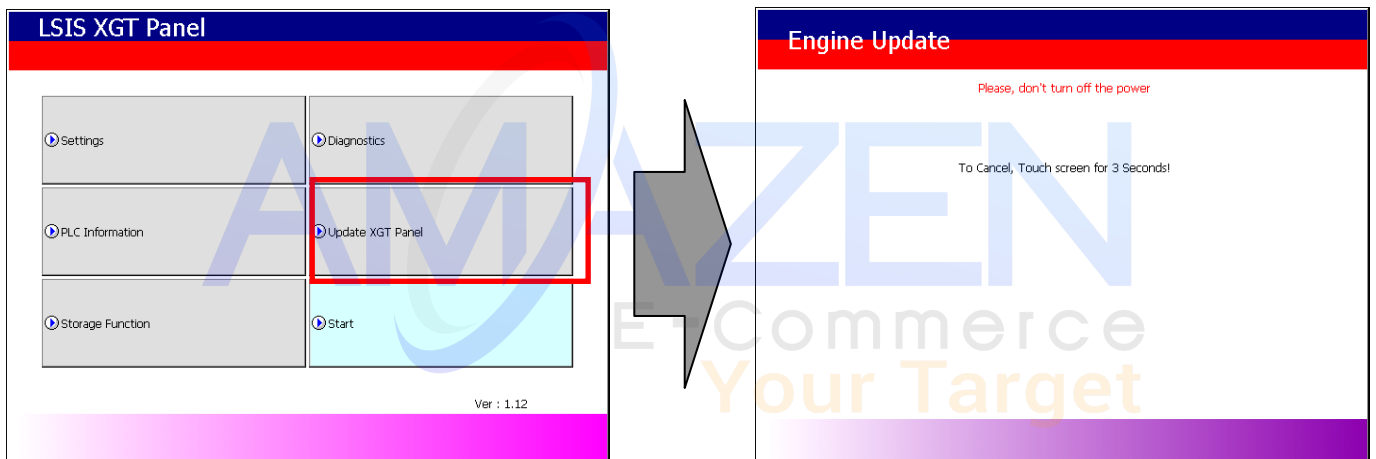

After downloading XGT Panel software from LSIS website, make a temporary folder and save it.

Designate the folder where the software will be saved in the XP-Builder's [XGT Panel Update] windows and update XGT Panel by [Send] menu. For more detailed information about XP-Builder, please refer to the XP-Builder user manual.

Remark

Do not remove communication cable or turn off the device during updating. It may cause the abnormal operation.

Chapter 9 File Backup through External Storage Equipment

Describes on management function about external storage equipment saving backup data of logging, recipe, and screen image

- (1) XGT Panel can back up the logging, recipe, and screen image data at CF card or USB storage equipment according to setting in XP-Builder.
- (2) In case there is no space for backup in the designated storage equipment, it continues backup deleting previous data or stops backup according to setting in XP-Builder
- (3) Monitors attachment status of backup equipment at XP-Builder.
- (4) In case the applicable storage device is not in use with safety removal switch of CF/SD card in operation, LED will be turned off right away. If the applicable storage device is in use, however, LED will be turn off as its use is over. Data backup will be done regularly only when LED is turned off and the device is removed.

9.1 Path Structure in case of File Backup

Backup path structure of logging, recipe, and screen image is as follows.

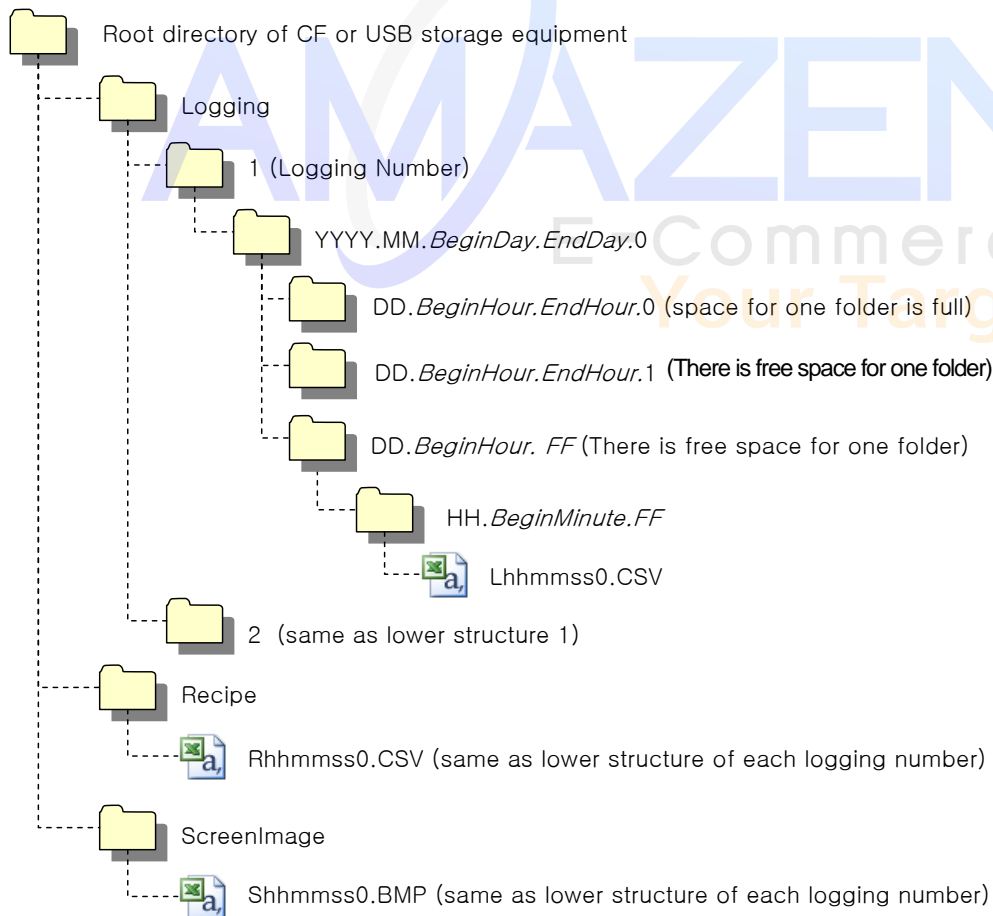

1. Path structure in case of logging backup

Chapter 9. File Backup through External Storage Equipment

- (1) Directory named 'Logging' is created under the root directory of USB/CF storage equipment
 - (2) The directory whose name is logging number is created under Logging directory.
 - (3) The directory whose name is year, month is created under Logging number directory.
 - (a) Includes day directory under
 - (b) Up to 500 day directories can be created.
 - (c) Name of year, month directory includes the firstly created day information under its directory

Ex) In case directory is created in 2010, October and includes directory since 15th under, directory's name is
: 2010.10.15.FF
FF at end means the directory can save more data created in 2010, October (currently, the number of lower directory is 500 or less)

 - (d) In case month is changed, changes directory name to day information of last created day directory.

Ex) In case month becomes November from October and directory from 15th directory to 30th have been created in 2010, October directory.
: 2010.10.15.30.0
 - (e) Though month is not changed, in case the number of day directory under year, month directory is 500 or above, directory name is changed into name including day information of last created day directory.

Ex) In case the number of directory from first to 15th is 500 or above in the directory created in 2010, October.
: 2010.10.01.15.0
 - (f) In case there is the year, month directory having same start day and end day when changing directory's name due to over 500 day directories or change of month, last digit index number increases.

Ex) In case there are three year, month directories that are having over 500 day directories created in October first and 2010 year October directory
: 2010.10.01.01.0
: 2010.10.01.01.1
: 2010.10.01.01.2
- (4) Day directory is created under year, month directory
 - (a) Hour directory is created under day directory
 - (b) Day directory can have up to 500 hour directory
 - (c) Name of day directory includes not day information but also hour information of first created hour directory
 - (d) Relation between day directory and hour directory is same as relation between year month directory and day directory.
 - (5) Directory whose name includes hour information is created under day directory.
 - (a) Hour directory includes backup file under
 - (b) Hour directory can include up to 500 backup file
 - (c) Name of time directory include not only hour information but also minute information of first created file under
 - (d) Relation between hour directory and backup file is same as relation between year, month directory and day directory.
 - (6) Name of logging backup file includes the created hour, minute, second information.
 - (a) Backup file is created in CSV format.
 - (b) File name start with 'L' meaning logging and includes hour, minute, second, index information
 - (c) In case backup file is created at the same time in terms of second, index information at the end of file name increases.
- ### 2. Path structure in case of recipe backup
- (1) Directory named 'Recipe' is created under USB/CF/SD storage equipment root directory.
 - (2) Year, month directory is created under Recipe directory
 - (3) The lower directory structure is same as that of logging backup path structure.
 - (4) Name of recipe backup file includes the created hour, minute, second information.
 - (a) Backup file is created in CSV format.
 - (b) File name start with 'R' indicating recipe and includes hour, minute, second, index information.

Chapter 9. File Backup through External Storage Equipment

(c) In case backup file is created at the same time in terms of second, index information at the end of file name increases.

3. Path structure in case of screen backup

- (1) Directory named 'Screen Image' is created under USB/CF storage equipment root directory.
- (2) Directory whose name is year; month is created under Screen Image directory.
- (3) The lower directory structure is same as that of logging.
- (4) Name of screen image backup file includes hour, minute, second information.
 - (a) Backup file is created in bitmap format.
 - (b) File name starts with 'S' and includes hour, minute, second, index information.
 - (c) In case backup file is created at the same time in terms of second, index information at the end of file name increases.

4. Structure of path at memo backup

- (1) 'Memo' directory will be formed at the sub route directory of USB/CF/SD storage device.
- (2) Directory in the name of Year and Month will be formed below the Memo Directory.
- (3) Structure of directory thereafter is same as that of logging backup route.
- (4) Memo backup file has the name made of hour/minute/second when it was created.
 - (a) Backup file is created in the type of bitmap.
 - (b) File name starts with 'M' that represents the screen image, which includes the index information of hour, minute, and second thereafter.
 - (c) In case backup file is created at the same time up to second, it increases the far end index information.

5. Structure of path at live image recording

- (1) 'Movie' directory will be formed at the sub route directory of USB/CF/SD storage device
- (2) Recorded live image is stored below the Movie Directory.
- (3) Live image file has the name made of year/month/date/hour/minute/second information when it was created.
 - (a) Backup file will be created in AVI type. H.264 and Mp3 were used for Video CODEC and Audio CODEC respectively.
 - (b) File name starts with 'MOV' that represents screen image, which includes data and hour information thereafter.
 - (c) Live image can be stored up to the number 1,000 files. This number can be designated at the special device settings of XP-Builder.

6. Structure of path when Blue Screen of camera image and live image is created

- (1) 'MovieStill' directory will be formed at the sub route directory of USB/CF/SD storage device.
- (2) Recorded live image will be stored below MovieStill directory.
- (3) Blue screen image file has the name made of year/month/date/hour/minute/second information when it was created.
 - (a) Backup file will be created in JPG type.
 - (b) File name starts with 'STL' that represents screen image, which includes data and hour information thereafter.
 - (c) Live image can be stored up to 1,000 files. This number can be designated at the special device settings of XP-Builder.

Remark

- (1) When changing device time, in case of changing current time into after time, we guarantee the normal operation. But in case of changing current time into early time, we don't guarantee the normal operation. In this case, you have to delete directory including the changed hour and its lower directory for normal operation. For example, if you change time from December 10th to December 5th, you have to delete year, month directory created in December 10th and restart the device
- (2) Sorting by project is not supported for each logging, recipe, screen image. For example, there are no.1, 2, and 3 logging groups in the project A. And in case each logging group backups the file, 1, 2, 3 directories are created and each data is saved under each directory. Then, in case file backup occurs in the project B having no.1, 2 logging group, backup file is created in same directory of project A. In this case, you have to sort the backup files of project A and B based on the created time.

Chapter 9. File Backup through External Storage Equipment

9.2 Operation setting when there is no space for backup

You can designate in the XP-Builder whether to cancel the backup or delete the oldest backup file and execute backup when there is no space in the storage equipment.

[Project Property Setting -> Storage Settings -> Backup Storage -> Delete old file if disk full]

1. In case of backup, deleting the oldest data

- (1) In case there is no space for backup, searches the oldest year, month directory under Logging, Recipe, Screen Image. (But in case of Logging, finds under Logging number directory. That is, when executing backup about Logging number 2, in case there is no backup data in Logging number 2 directory and there is data only in logging number 1, data of logging number 1 is not searched/deleted.)
- (2) Searches the oldest day directory under the oldest year, month directory.
- (3) Searches the oldest hour directory under the oldest day directory.
- (4) Deletes the oldest backup file under the oldest hour directory
- (5) Checks the space and if more space is necessary, the above steps of (1) ~ (4) are repeated and checks the space.
- (6) When deleting file, in case all data in time directory are deleted, relevant hour directory is deleted.
- (7) When deleting hour directory, in case all hour directories in day directory are deleted, relevant hour directory is deleted.
- (8) When deleting day directory, in case all day directories in year, month directory are deleted, relevant year, month directory is deleted.

Remark

- (1) In unknown directory or file (user file or directory), searches the oldest thing among normal backup files except unknown directory or file.
- (2) In case there is nothing except user data in now searched directory, backup operation fails. XGT Panel can't delete user data, at this point, operation stops.

9.3 Structure of path of video file and video capture files

1. Movement when file is added

- (1) When the name of created file is MOV_120220_121212.avi, the directory will be created as follow;

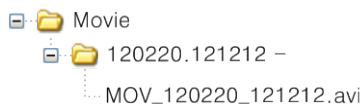

- (2) When MOV_120220_200101.avi file is created again thereafter, the applicable directory is added by subdirectories as follow until it fills 500 files.



(3) When 500 files are filled with MOV_120330_110101.avi as its last one, the name of directory will be change as follow;

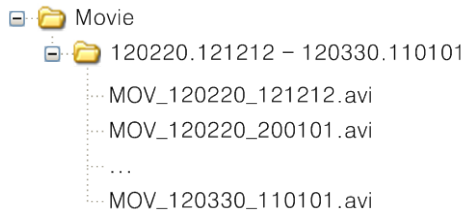

(4) When the 501st file (MOV_120330_110230.avi) is created, a new directory will be created as follow;

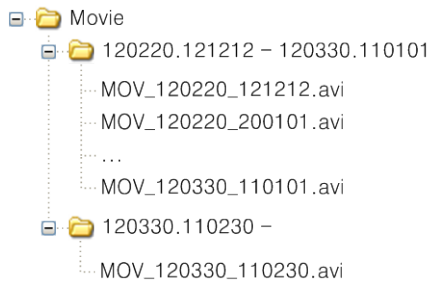

2. Movement when the domain is short or it exceeds the designated limit

- (1) In case of designating the property related with storage device for the XP-Builder project – At the time of setting video file and video capture, if you check at [Delete Old File when Domain is full], it operates by deleting the oldest file when the space is short or it exceeds the limited number of directories. When you release such check, it stops operation together with error code when the space is short.
- (2) When the number of directories filled with 500 files becomes 100;
 - It deletes the oldest file in the oldest directory. When the directory gets empty, that directory is also deleted.
- (3) When there is no available space in the storage device;
 - It deletes the oldest file in the oldest directory. It requires minimum 10MB to save the live image and minimum 1MB to save video capture file. It deletes out the oldest file one by one until such space is secured. When the directory gets empty, that directory is also deleted.

3. ActiveSync –related movement

- (1) When in connection with ActiveSync
When in connection with ActiveSync, it doesn't make any specific operation. In case you deletes and move the file in the storage device with ActiveSync in connection, the applicable mode is not reflected in the motion of device. That is, deletion of file doesn't cause update of the device of the number of video files or the value of video capture file device.
- (2) When out of connection with ActiveSync
When out of connection with ActiveSync, it renews the list of stored video file and video capture file in the storage device again. During this time, it is impossible to start recording or replaying. Through the status device, you can confirm when the motion of file list preparation will be stopped.

4. Motion when dismounting the storage device

- (1) When mounting the storage device
Please scan the entire video file and video capture file, prepare the list, and find out the total number. During this time, it is impossible to start recording or replaying. Through the status device, you can confirm when the motion of file list preparation will be stopped.

Chapter 9. File Backup through External Storage Equipment

9.4 Monitoring Connection Status of External Storage Equipment

XGT Panels monitors connection status about external storage equipment designated when setting backup path in XP-Builder. The following figure is backup path specified in XP-Builder.

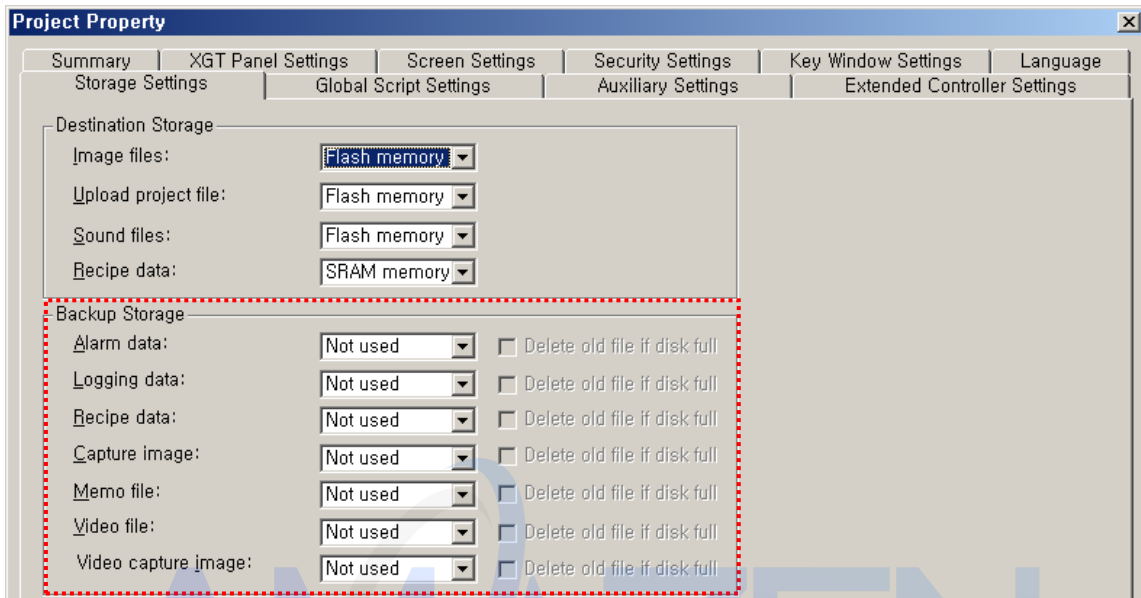

In order to use this monitoring function, you have to set about system alarm window

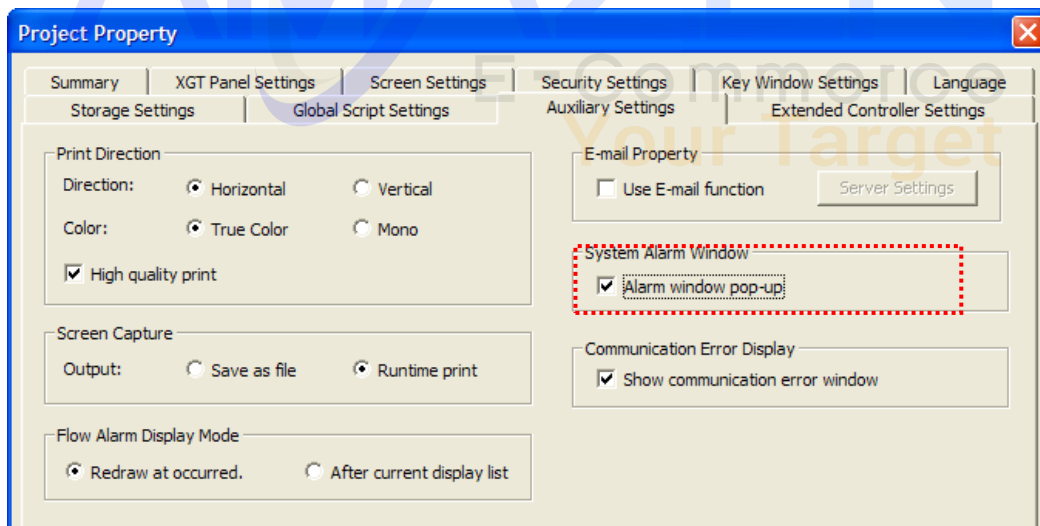

Chapter 9. File Backup through External Storage Equipment

In case USB storage equipment (or CF storage equipment) is removed during operation after setting the path for saving Logging backup file as USB storage equipment (or CF storage equipment) and downloading the project into device, the designated system alarm (HS951.0) is set. In case storage equipment is equipped again, alarm is reset.

In case USB storage equipment (or CF storage equipment) is removed during operation after setting the path for saving Recipe backup file as USB storage equipment (or CF storage equipment) and downloading the project into device, the designated system alarm (HS951.1) is set. In case storage equipment is equipped again, alarm is reset.

In case USB storage equipment (or CF storage equipment) is removed during operation after setting the path for saving Screen Image backup file as USB storage equipment (or CF storage equipment) and downloading the project into device, the designated system alarm (HS951.2) is set. In case storage equipment is equipped again, alarm is reset.

Internal address of the designated system alarm can be checked in XP-Builder as follows.

	Device	Data Type	Description
1	HS950.0	BIT	NVRAM Low Battery Warning
2	HS950.1	BIT	NVRAM Invalid Data Warning
3	HS951.0	BIT	No Logging Backup Storage
4	HS951.1	BIT	No Recipe Backup Storage
5	HS951.2	BIT	No Screen Backup Storage
6	HS951.4	BIT	No Printer
7	HS950.8	BIT	USB Over Current Warning
8	HS951.3	BIT	No Alarm Backup Storage

9.5 Safety Removal Switch

In order to remove the storage device, you can use safety removal switch to guarantee that data was backed up with safety

LED is turned off if you remove the storage device right away without any motion of safety removal switch. If you operate safety removal switch, LED will be turned off right away if there is no backup function with storage device in current use. In that case, LED will be turned off when such work is all over, and will internally turn off the connection with the storage device. That is, when LED is turned off, you cannot backup anything in the storage device, and may not use data in the storage device such as file recipe, etc. Therefore, you need to remove and then mount the storage device again in order to operate safety removal switch and then use it again after LED is turned off. When you operate safety removal switch and re-mount the storage device, you are required to re-mount it at least after 5 seconds in case of SD card while 3 seconds in case of CF card.

With the following function in operation, LED will not be turned off even with safety removal switch in operation. LED will be turned off with the applicable mode completed. It will not be turned off during the creation of backup data or during the Read mode in the XP-Builder. It will not be turned off during the Load mode as the image stored in XP-User Image in the storage device is used as part image. It will not be turned off during the file recipe Write or Read mode. It will not be turned off during Backup Data Read mode in XP-Server using the XP-Link communication. It will not be turned off during the Inquiry mode of the list of backup files to be uploaded from the XP-Builder. It will not be turned off during the Load mode of sound file or image included in the Project. It will not be turned off during the Read mode of Project Backup Data with the storage device or from the XP-Builder. It will not be turned off when it downloads the project in the device using XP-Builder or storage device. It will not be turned off when it is changing the start menu image. It will not be turned off with the ladder monitor program stored in the storage device in operation.

Chapter 9. File Backup through External Storage Equipment

Function	Sub-classification	Movement
Data Backup	Alarm	Write
	Logging	Write
	Recipe	Write
	Screen	Write
	Memo	Write
	Video	Write
	Still Shot	Write
Data Upload	Alarm	Read
	Logging	Read
	Recipe	Read
	Screen	Read
	Memo	Read
	Video	Read
	Still Shot	Read
Function-wise Data	Part Image	Read
	File Recipe Edit	Read/Write
	File Recipe Transfer	Read/Write
Web Server	Webpage Create	Write
XP Link File Transfer		Read
File List Inquiry		Read
Project Upload	Project Backup – Communication	Read
	Project Backup - Storage Device	Write
Project Download	Image	Write
	Sound	Write
	Project Backup	Write
Ladder Monitor	Download	Write
	Execute	Read
Changing default Image		Read
Storage Device Download	Project Data	Read

Chapter 10 Installation and Wiring

10.1 Installation

10.1.1 Installation environment

This machine has high reliability regardless environment. But for reliability and stability, be careful the followings

(1) Environment condition

- (a) Install at the panel which can protect this machine from water and dust.
XGT Panel is designed by IP65 Standard in front parts and IP20 Standard in rear parts.
- (b) Install at the place where impact and vibration is not continuously applied.
XGT Panel is designed to meet IEC standard (IEC 61131-2).
- (c) Do not expose this machine to direct light.
- (d) Do not install at the place where rapid temperature change can occur.
Moisture by rapid temperature change can cause malfunction and damage.
- (e) This machine should be installed within 0 ~ 50°C, otherwise the screen may be changed or cause malfunction
- (f) This machine should be installed within 10~85% relative-humidity.
Moisture by rapid temperature change can cause malfunction and damage.
- (g) Avoid corrosive gas and burnable gas.

(2) Installation construction

- (a) When doing screw's processing or wiring construction, be careful that the remains do not enter the XGT Panel inside.
- (b) Install at the place where you can easily control.
- (c) Do not install with high voltage machine within same Panel.
- (d) Keep distance of more than 100mm from duct for wiring and peripheral machine.
- (e) Ground at the place where few noises develop.

(3) Anti-heat design of control panel

- (a) In case of installing XGT Panel in the airtight panel, consider the heat by other machine as well as own heat. In case that the air circulates through a ventilating opening or a general pan, XGT Panel system can be influenced by in-draft of dust or gas.
- (b) We recommend you to install a filter or to use an airtight heat exchanger.

Remark

(1) Protection standard

- 1) Ingress Protection (IP) is based on the IEC 60529 Standard for degrees of protection provided by enclosures.
It includes the degree of protection against solid objects and of protection against water ingress.
- 2) IP65 rating guarantees the enclosure is dust proof (6) and protected against jets of water (5).
- 3) IP20 rating guarantees protection from solid foreign objects of 12mm diameter and greater (2), but it does not guarantee protection from water ingress.

Chapter 10. Installation and Wiring

Element	Numerals or letters	Meaning for the protection of equipment	Meaning for the protection of persons
Code letters	IP		
First characteristic numeral	0 1 2 3 4 5 6	Against ingress of solid foreign objects (non-protected) ≥ 50 mm diameter ≥ 12.5 mm diameter ≥ 2.5 mm diameter ≥ 1.0 mm diameter Dust-protected Dust-tight	Against access to hazardous parts with (non-protected) Back of hand Finger Tool Wire Wire Wire
Second characteristic numeral	0 1 2 3 4 5 6 7 8	Against ingress of water with harmful effects (non-protected) Vertically dripping Dripping (15° tilted) Spraying Splashing Jetting Powerful jetting Temporary immersion Continuous immersion	
Additional letter (optional)	A B C D		Against access to hazardous parts with back of hand Finger Tool Wire
Supplementary letter (optional)	H M S W	Supplementary information specific to: High-voltage apparatus Motion during water test Stationary during water test Weather conditions	

<Source: IEC60529>

(2) Caution

- 1) The XGT Panel is designed to mount on the panel, so that the front side meets the standard. However, it does not guarantee the installation environment.
- 2) The product may malfunction or break down if the installation environment is not suitable for the protection rating.
- 3) The standard is only for protection from dust and water. Use care to protect against oil, corrosives, or metal particles.
- 4) If the gasket breaks down due to exposure to chemicals or continuous vibration, the protection from dust and water may be weakened.
- 5) When you install or mount the XGT Panel, be careful not to damage the product.

10.1.2 Notice in handling

It describes the notice from opening to installation.

- Do not drop or cause heavy impact.
- Do not disassemble voluntarily. When doing this, we are not responsible for the product.
- When wiring, be careful that the remains do not enter into XGT Panel.

10.1.3 Notice in installing the panel

Here describes how to install XGT Panel in panel and notice.

(1) Panel cut

- Before installing the XGT Panel in panel, panel should be made with the following dimension.

Unit: [mm]

Classification	X (Wide)		Y (Height)		Z (Thickness)
iXP70-TTA	259.0	+1	201.0	+1	1.6-9.5
		-0			
iXP80-TTA	301.5	+1	227.5	+1	
		-0			
iXP90-TTA	383.5	+1	282.5	+1	
		-0			

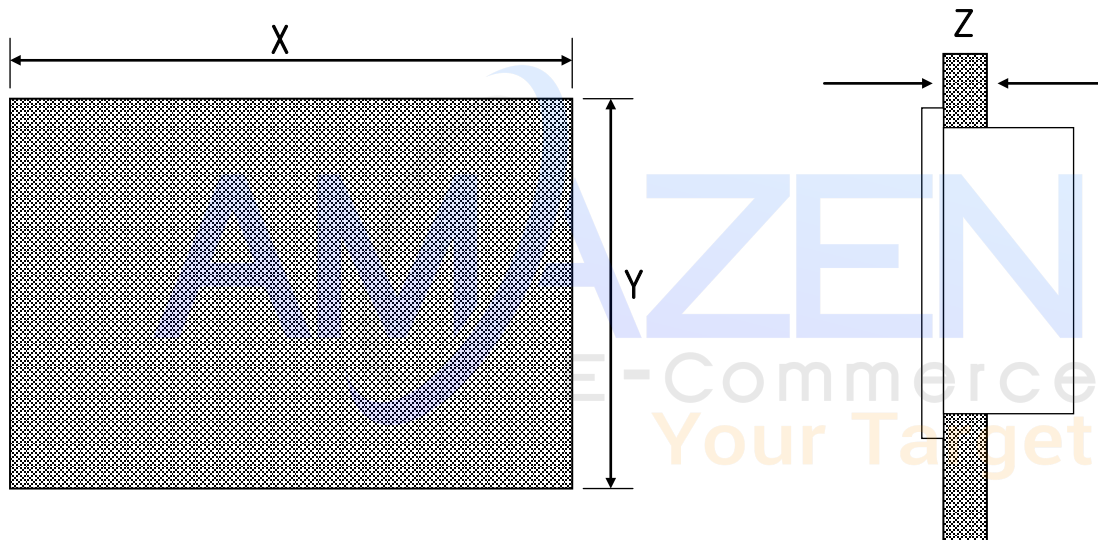

Chapter 10. Installation and Wiring

(2) XGT Panel installation

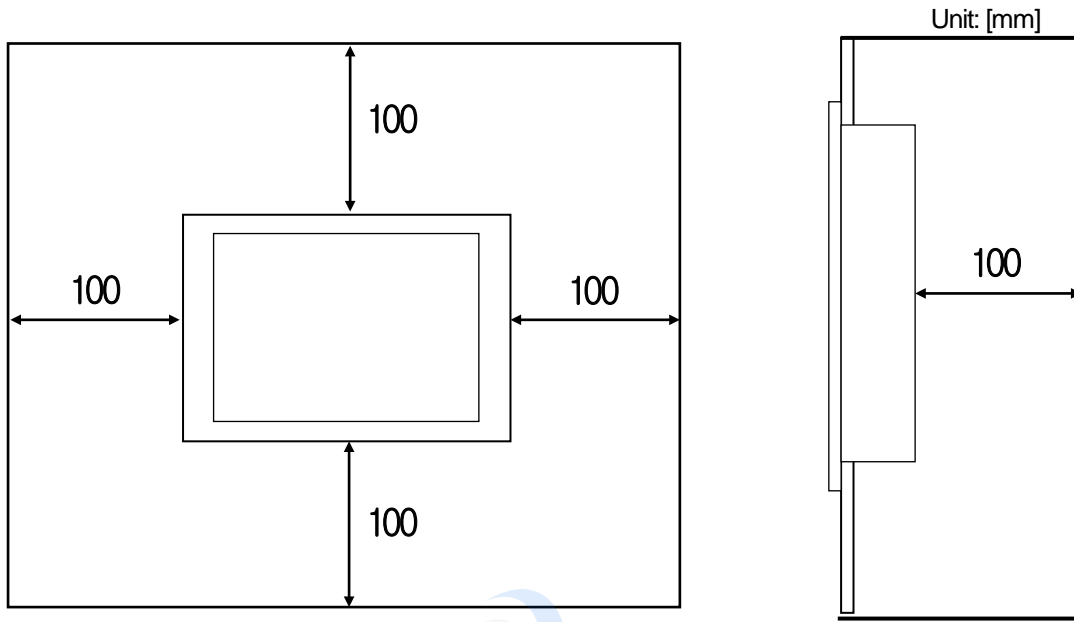

- Keep the distance of 100 mm between XGT Panel and panel per each direction.

Remark

- (1) To be affected at a minimum by the electromagnetic waves (radial noise) or heat from other controllers, it needs to keep its distance as the above explanation.
- (2) When installing, consider the power and communication cable wiring.
- (3) If the size of the panel cutout dimensions are beyond the error range (0-1mm), the contact surface between the gasket and the panel may be reduced. This may weaken the protection from water and dust ingress.

- When mounting the XGT Panel inside a panel, ensure that you use the gasket to protect against dust or water ingress.

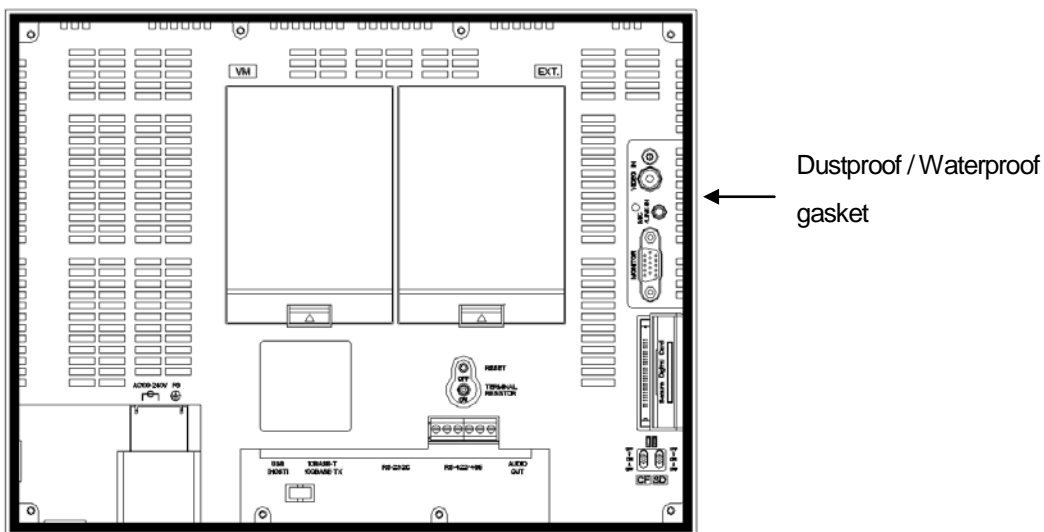

Remark

- (1) Use the gasket to prevent dust or other contaminant ingress.
- (2) When you mount the XGT Panel on the panel, if the surface of panel is uneven, water or dust can enter the product through the gaps. This can be caused by the quality of the material (iron, aluminum, or acrylic) or the thickness, so check the installation environment carefully. Moreover, be sure to adhere the gasket and panel.
- (3) If the gasket is damaged when you install the product or is deteriorated after a long period of use, it may weaken the protection from water and dust ingress. If you need to replace it, contact the agency or a service center.

(3) Installation location

- When installing the XGT Panel, consider screen and use of touch.
- When you don't see within the following angle, you may not see clearly. When installing, consider angle.

Item	Left and Right	Upper	Lower
iXP70-TTA	80 deg.	60 deg.	80 deg.
iXP80-TTA	80 deg.	60 deg.	80 deg.
iXP90-TTA	80 deg.	60 deg.	80 deg.

(4) Fixation

- Fix XGT Panel to the panel using the supplied brackets provided in the OEM packaging.

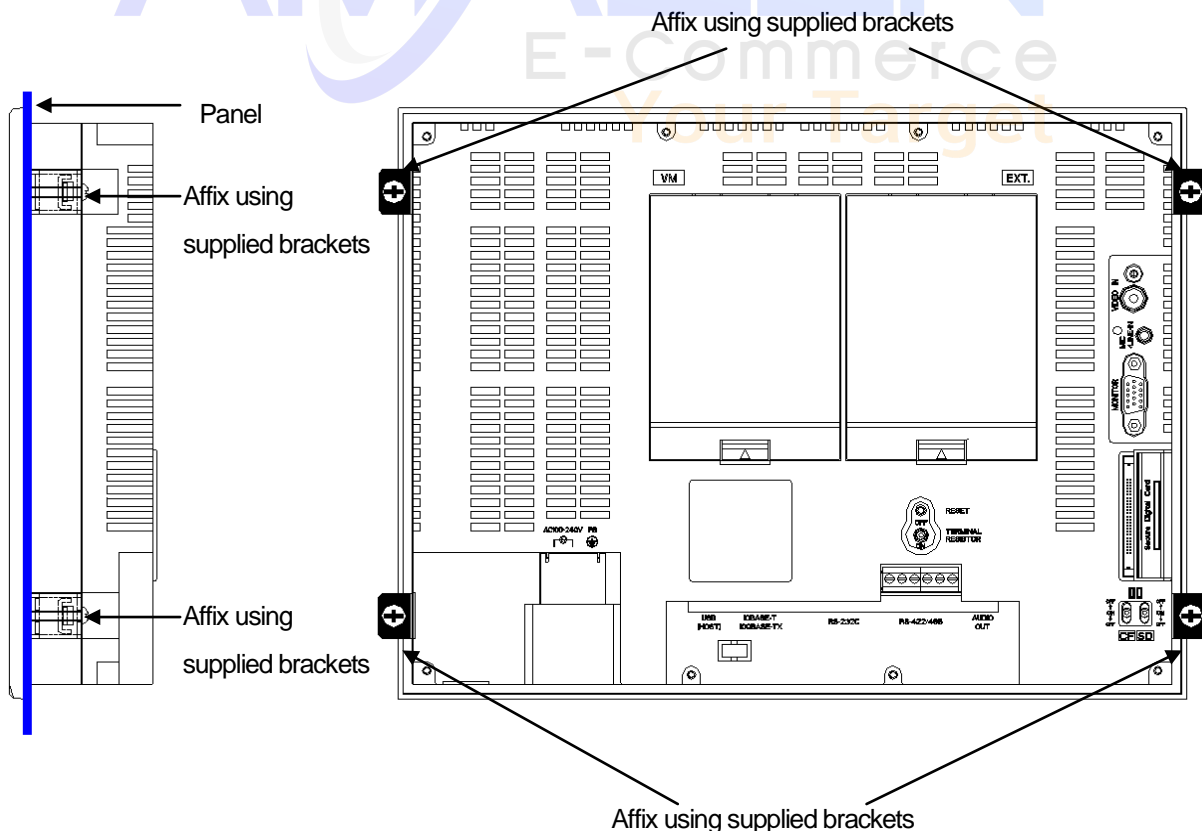

Chapter 10. Installation and Wiring

Remark

- (1) Affix the brackets on four sides of the product to prevent ingress by water and dust.
- (2) Affix the brackets top to bottom and right to left to prevent gaps.
- (3) Align the brackets vertically with the panel. The screw torque of the brackets is 6.42kgf/cm. The screw torque may vary by the quality of the panel, but it should follow the standard screw torque value for a bolt. If you apply excessive force when affixing the brackets, the XGT Panel can be damaged. This may result in touch screen errors or weaken the protection against water and dust ingress.
- (4) After mounting the XGT Panel on the panel, remove the screen protection film. Touch screen errors may result if the film is not removed. To protect the screen, use the exclusive protection sheet. To purchase a protection sheet, contact the agency or a sales office.

10.2 Wiring

It describes the wiring that you should know when installing the XGT Panel.

10.2.1 Power wiring

XGT Panel is divided into the DC product and the AC product.

Power	Name
DC 12/24V	iXP70-TTA/DC
	iXP80-TTA/DC
	iXP90-TTA/DC
AC 100-240V	iXP70-TTA/AC
	iXP80-TTA/AC
	iXP90-TTA/AC



Warning

- ▶ If AC power is applied into the product for DC power, It may cause damage or fire. Be careful of connection.
- ▶ 'DC' is the product which use DC 12/24V, and 'AC' is the product which use AC 100-240V. When using the product, Please check the label in the back of the product.

The power terminal should have the following specification.

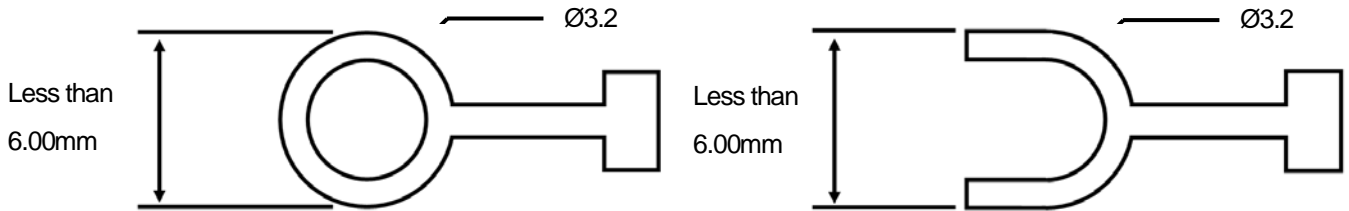

The power cable should have the following specification.

Type	Cable specification (Unit: mm ²)
Power and protection ground	1.5 (AWG16) ~ 2.5 (AWG12)

Remark

- (1) For installations where there is voltage drop, it is recommended to use stranded wire with a cross sectional area 1.5~2.5 mm².
- (2) It is recommended that cable connections are twisted and secure. Short cable runs are also recommended Between the point of supply and the XGT panel.
- (3) For safety reasons it is recommended that you use color coded outer sheaths on the conductors to aid safe terminations.
Follow local regulations when making electrical connections.

Wiring of power is as follows.

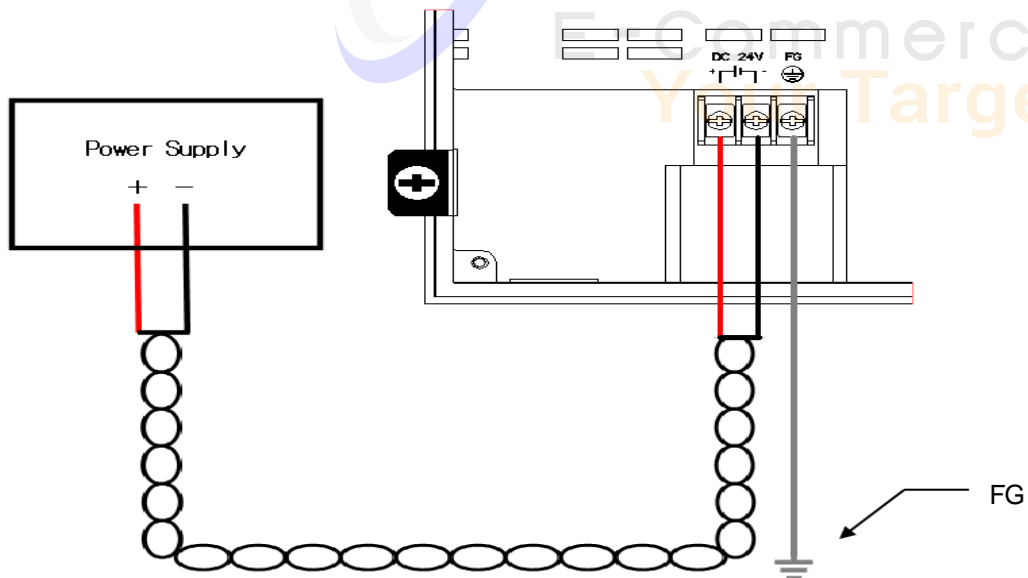

DC Power connection

Chapter 10. Installation and Wiring

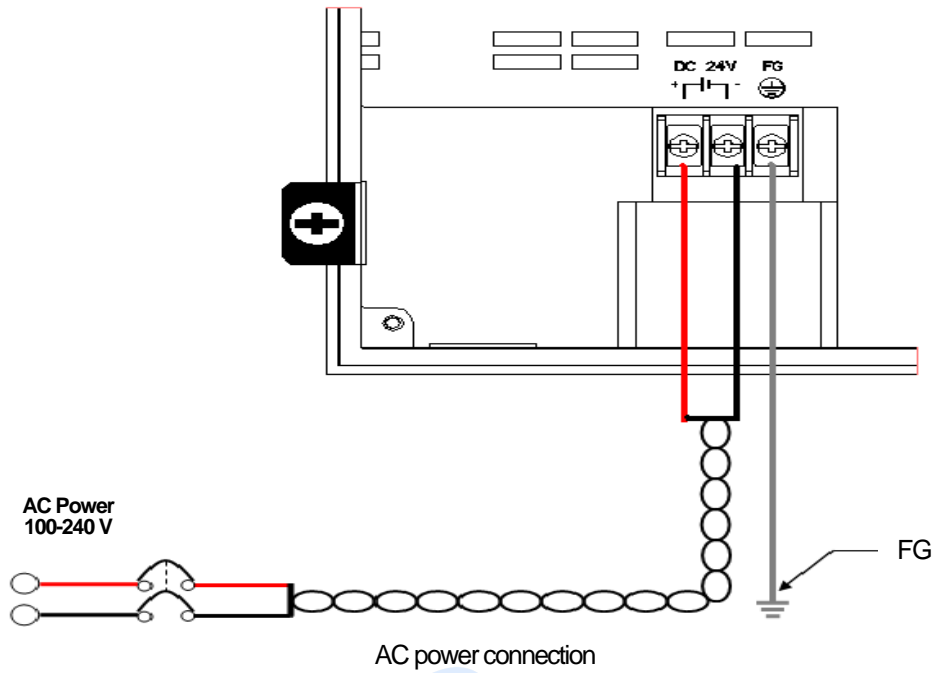

Remark

- (1) Use a regulated power supply transformer when the power fluctuation is bigger than the standard.
- (2) If electromagnetic interference is experienced or expected use an insulation transformer to protect the XGT panel from interference.

Separate the XGT Panel power from the I/O device and main circuit device.

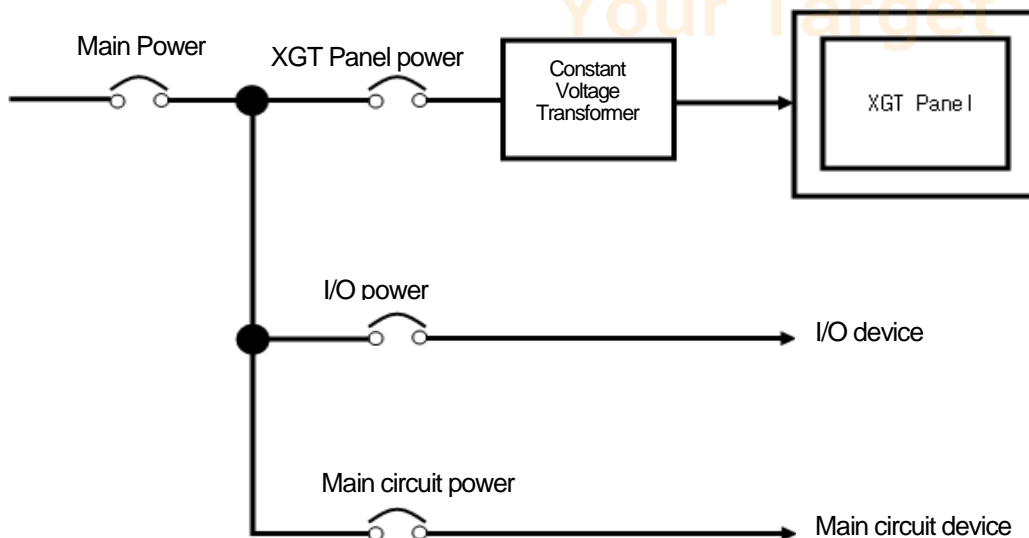

Remark

- (1) Separate the XGT Panel power supply cable from the main circuit cable (high voltage and current) and input/output cable. Maintain a minimum separation of 100mm between cables.

Use a lightning surge protector to prevent damage from lightning strikes.

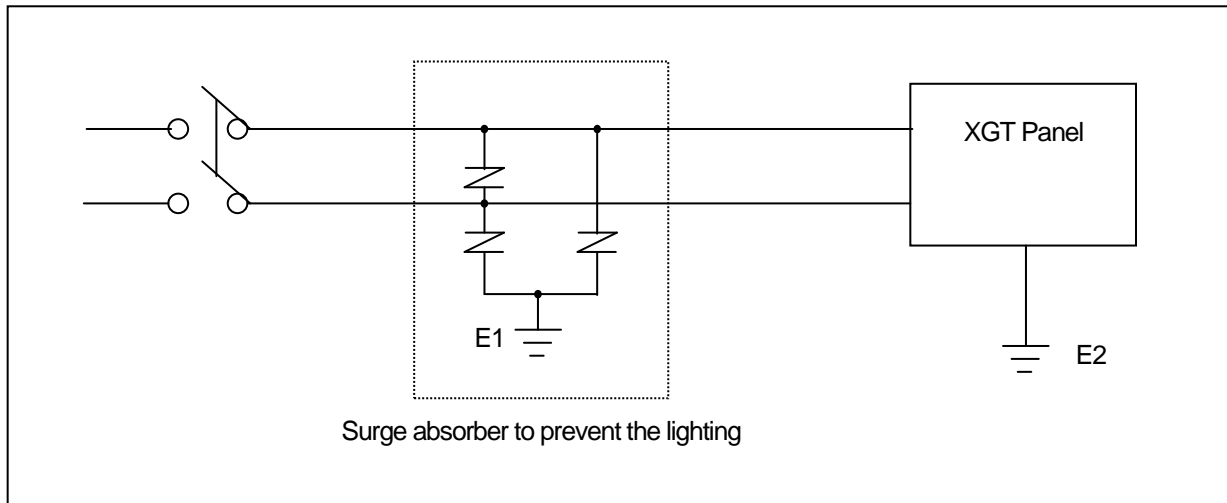

Remark

- (1) Separate E1, the ground connection for lightning surge protector, and E2, the ground connection for XGT Panel.
- (2) Set lightning surge protector to below the allowable surge voltage to provide protection if the voltage increases to its maximum.

Use an insulation shielding transformer or noise filter when the electromagnetic interference occurs. Keep the stripped ends of the terminated cables twisted and as short as possible. When running the wiring avoid running the cables for the insulation shielding transformer or noise filter pass through the cable duct.

When you use the magnetic lighting contactor (MC) for AC/DC, it is recommended to use a ferrite core close to the power terminals as shown below:

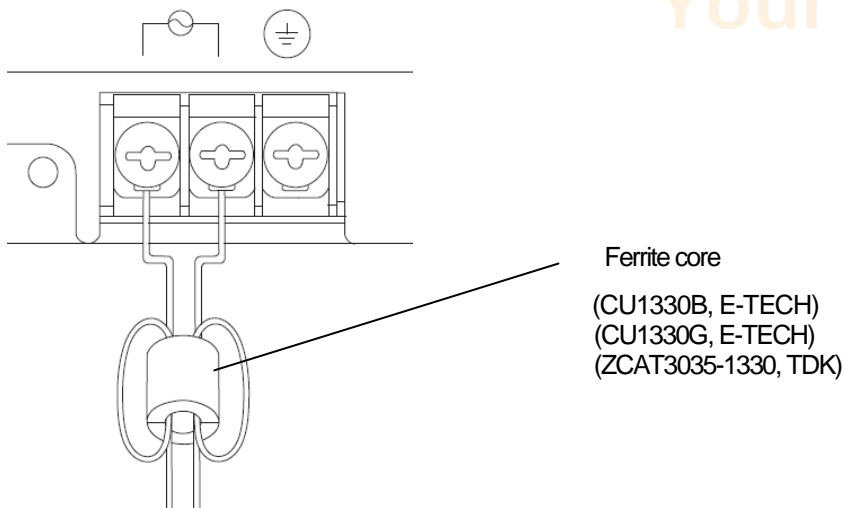

Chapter 10. Installation and Wiring

10.2.2 Ground wiring

- (1) Our XGT Panel has enough anti-noise measure, so except that there are many noises specially, the ground is not needed. When you use the ground connection, refer to the following information.
- (2) Use the exclusive ground connection. When you install the ground connection, use the third grounding resistance (less than 100Ω).
- (3) If you cannot use the exclusive ground connection, use the common ground connection like below.

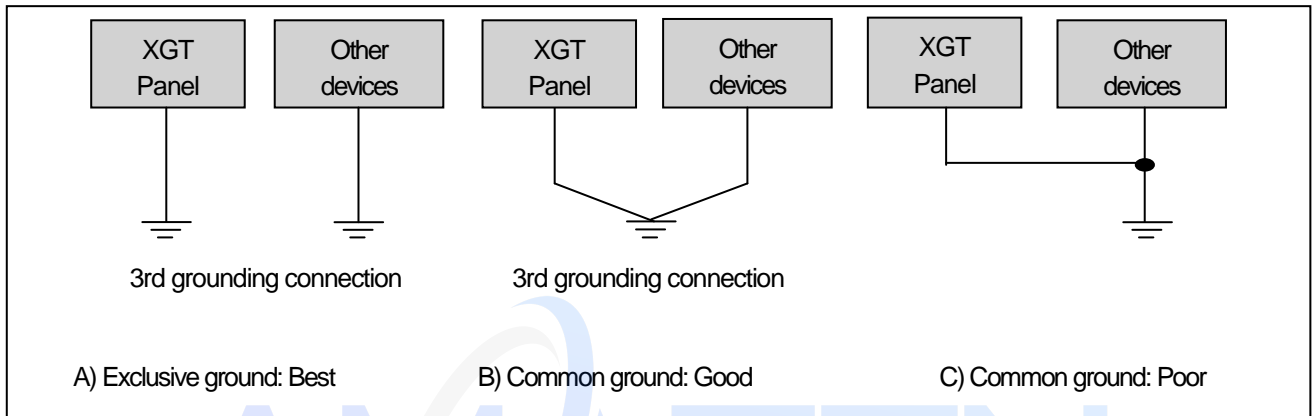

- (4) Use cables for grounding/earth connections by using cable with a cross sectional area greater than 2.0 mm^2 . Install the ground connection as close as possible to the XGT Panel.

Remark

- (1) Check and test the grounding connection. If the connection is bad or in case of (B) above, the XGT Panel may malfunction or the communication signals may fail.

Chapter 11 Maintenance

To keep the XGT Panel best, examine the XGT Panel.

11.1 Maintenance

Because an error may be developed by environment, the periodic maintenance is needed. You should check the following categories once or twice every 6 months.

Maintenance category		Criterion	Action
Power		Within the power change range (Within -15% / +10%)	Modify the source of electric power in order to be in the fluctuation range of a permissible voltage.
Environment	Operating temperature	0 ~ + 50 °C	Modify the operating temperature and humidity to be proper.
	Operating humidity	10 ~ 85%RH	
	Vibration	No vibration	Use the anti-vibration rubber and make a count measure.
Getting loose of power terminal		There is no unwinding	Screw the unwound terminal.
Getting loose of communication connector		There is no unwinding	Screw the unwound terminal.
Reserved part		Amount of reserved part and reservation Check the status	Refill the insufficiency and improve the reservation.
Gasket installation status		No gap between the gasket and panel.	Replace gasket or affix brackets firmly
Gasket status		No damage or deterioration	Replace gasket

11.2 Daily Maintenance

Check the followings daily.

Maintenance category	Maintenance contents	Criterion	Action
Mounting status	Check the brackets	Should be mounted firmly	Retighten screws
Power terminal status	Loose terminal screws	Not loose	Retighten screws
	Reduce the distance between compressed terminals.	Keep the proper distance.	Correction
Communication connector status	Unwinding of fixed screw	Not loose	Retighten screws
Indication LED	Check the lighting	Green LED should be turned on	Refer to the appendix 1.

11.3 Periodical Maintenance

Check the followings once or twice every six months and take measure.

Maintenance category		Maintenance method	Criterion	Action
Environment	Surrounding temperature	Measure through temperature/Hygrometer Measure of corrosive gas	0 ~ 50 °C	Modify it to meet the general standard. (environment standard in the panel)
	Surrounding humidity		10 ~ 85%RH	
	Surrounding pollution degree		No corrosive gas.	
XGT Panel Status	Unwinding, swing	Move XGT Panel	Fixed firmly	Retighten screws
	Dust, foreign matter adhesion	Visual check	Not loose	-
Connection status	Looseness	Retighten screw with Screwdriver	Not loose	Retighten screws
	Reduce the distance between compressed terminals.	Visual check	Keep the proper distance.	Correction
	Loose connectors	Visual check	Not loose	Wind the fixed screw of connector
	Loose brackets	Retighten screw with Screwdriver	Not loose	Retighten screws
Power voltage maintenance		Check the power voltage of input terminal of power by test	AC100~240V: AC85~ 264V DC24V: DC19.2 ~ 28.8V	Supply power modification
Battery		Check when battery is exchanged and voltage drop is indicated (It is expressed by system alarm)	<ul style="list-style-type: none"> • Check the total of power stoppage time and guarantee duration • There is no battery voltage drop indication 	If guarantee duration is exceeded even though there is no battery voltage drop indication, change the battery.
LCD Backlight maintenance		Visual check	Check the guarantee duration	When error occurs, change the backlight.
Touch status	Touch location error	Check at the Diagnostics of XGT Panel	Appropriate touch location	Reset at the setting of XGT Panel.
	Damage or deterioration of protection sheet	Visual check	There is no damage or deterioration	When error occurs, change protection sheet

Remark

- (1) Battery exchange time is expressed by alarm. System alarm is expressed when system alarm category is set at the XP-Builder as follows.

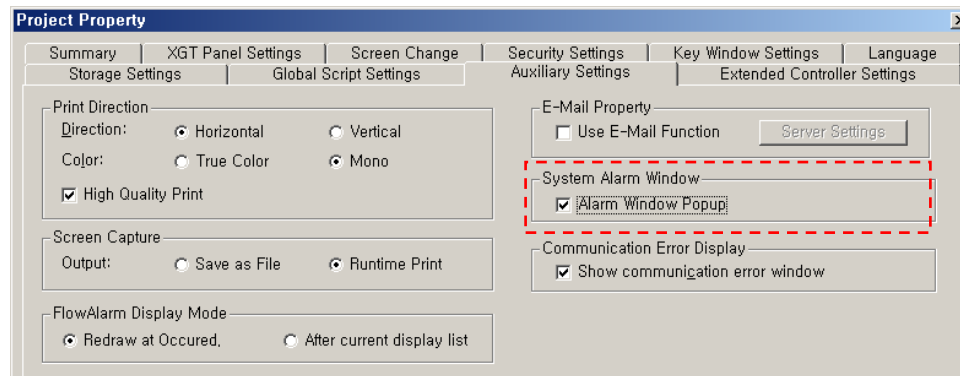

- (2) iXP model LCD backlight is not replaceable. Therefore when backlight has some problem or it is no longer of any use, LCD has to be replaced.

AMAZEN
E-Commerce
Your Target

Chapter 12 EMC Standard Certification

12.1 Requirement for EMC Standard Certification

EMC command is regulated on “It doesn’t produce the Strong electromagnetic waves: Emission” and “It is not affected by electromagnetic wave from external: Immunity”. The following is describing the contents to meet the EMC command when configuring the system by using the XGT Panel. This is a summary document for the request and standard which our company has obtained from EMC but we don’t assure that all devices manufactured according to these contents are not suitable for the below standards. The final manufacturer needs to finally judge about the fitness method or fitness judgment of EMC command.

12.1.1 CE standard certification

Applied Standards		Results
1. Emission		
Conducted Disturbance	EN61000-6-4:2007	C
Radiated Disturbance	EN61000-6-4:2007	C
Harmonic Current Emission	EN61000-3-2:2006 / A2 : 2009	NA ^{㉔2)} NT ^{㉔3)}
Voltage Change, Fluctuations and Flicker	EN61000-3-3:2008	NA ^{㉔2)} NT ^{㉔3)}
2. Immunity		
Electrostatic Discharge	EN61000-6-2:2005	C
	EN61000-4-2:2009	
Radio-Frequency Electromagnetic Field	EN61000-6-2:2005	C
	EN61000-4-3:2006 / A1 : 2008	
Fast Transient	EN61000-6-2:2005	C
	EN61000-4-4:2004	
Radio-Frequency Continuous Conducted	EN61000-6-2:2005	C
	EN61000-4-6:2009	
Power-Frequency Magnetic Fields	EN61000-6-2:2005	C
	EN61000-4-8:1993 / A1 : 2001	
Surges	EN61000-6-2:2005	C
	EN61000-4-5:2006	
Voltage Dips and Interruptions	EN61000-6-2:2005	NA ^{㉔2)} C ^{㉔3)}
	EN61000-4-11:2004	
RE1) C=Conform NC=Not Conform NT=Not Tested NA=Not Applicable RE2) Applicable to the only iXP70-TTA/DC, iXP80-TTA/DC, iXP90-TTA/DC RE3) Applicable to the only iXP70-TTAAC, iXP80-TTA/AC, iXP90-TTA/AC		

Chapter 12. EMC Standard Certification

Directive:

Electromagnetic Compatibility Directive 89/336/EEC amended by the Directive 93/68/EEC



12.1.2 KC standard certification

The XGT Panel acquires the electromagnetic fitness registration (KC specification) certified by wave laboratory under information-communication part.

A grade device

This device acquires KC for industrial use.

If device is not purchased properly, exchange it to device for home use.



12.2 Requirement for Low Voltage Command Suitability

It is required to get the needed Stability for the device operated at AC50~1000V, DC75~1500V's power. The following describes attention about installation and wiring for the suitability when using the XGT Panel. Though the following data is made by requirement of regulation and standard, we don't guarantee that all devices are suitable for the above command. The method to be suitable for the EMC command and judgment of suitability should be finally made by device manufacturer himself.

12.2.1 Standard certification for XGT Panel

XGT Panel is according to the EN61131-2:2007 (stability of device used in the measure, control laboratory). XGT Panel, iXP70-TTA/AC, iXP80-TTA/AC and iXP90-TTA/AC, is made to meet the above standard.

12.2.2 Selection of XGT Panel

- (1) iXP70-TTA/AC, iXP80-TTA/AC, iXP90-TTA/AC

Because the Power module whose rated input voltage is AC100-240V has danger voltage (voltage of more than 42.4V), the product which is suitable for CE mark is having the improved insulation between internal 1 and 2.

- (2) iXP70-TTA/DC, iXP80-TTA/DC, iXP90-TTA/DC

The I/O module under DC12V exceeds the range of low voltage command target.

Appendix 1 Troubleshooting

1.1. Type of Problem

It classifies problems from XGT Panel including an indicated figure, indication of the object, and problems appeared when downloading. Refer to the following chart.

Classification of problem	Description
Problem when starting	Malfunction when starting. ☞ Please refer to the 2. Problem when starting.
Problem when touching	In case that there is no reaction when touching. ☞ Please refer to the 3. Reaction problem when touching.
Display problem of figure and object.	In case that the figure or object is different from when editing. ☞ Please refer to the 4. Indication problem of figure and object.
Communication problem	In case that communication is not executed properly. ☞ Please refer to the 5. Communication problem.
Error message when executing program	In case that an error message occurs when operating the XGT Panel. ☞ Please refer to the 6. Error message when executing program.

1.2. Problem when Starting

Why does black screen show up when turning on the device?

Phenomenon: When turning on the device, black screen shows up and the booting is impossible.

< Cause >

- (1) Because the device is not set as a booting mode.
- (2) Black screen may appear because of malfunction of backlight.

<Solution>

- (1) because the device is not set as a booting mode, the above problem can occur. Check whether the number 2 switch at DIP switch in the back of the device is in A direction or not.

When is the color of LED changed?

Please check the followings.

Display color	Contents
GREEN	Power is supplied to XGT Panel

1.3. Reaction Problem when Touching

When touching the screen it reacts in a different area or it may not react at all?

Phenomenon: When touching the screen it reacts in a different area or it may not react at all.

< Cause >

- (1) Touch's Calibration setting is not proper.
- (2) Touch panel may be a break down.

<Solution>

- (1) Redo Calibration setting about touch. Refer to the [Device manual Ch.4.1 Touch Calibration].
- (2) If you can't go to setting menu, connect mouse to USB port and use mouse.

Buzzer does not sound.

Phenomenon: When pressing buzzer, buzzer does not sound.

< Cause >

- (1) When that the switch operates but the buzzer doesn't sound, the buzzer is set as no sound.
- (2) If the switch doesn't work too, it seems that some error occurs in the touch function.

<Solution>

- (1) Redo environment setting for buzzer to sound. Refer to the [device manual Ch.4.7 Environment Setting].
- (2) After setting to use buzzer, check whether the buzzer sounds or not in the 1)'s setting windows.

There is no sound during the video recording

Phenomenon: Sound is not saved at the time of video recording

<Cause>

- (1) Sound input may be abnormal.
- (2) Sound is not recorded when the sound input is connected with sound output.

<Solution>

- (1) Be sure to check the sound input is normal. Check [Line-in/MIC bypass to speaker] in the XGT Panel start menu [Settings]-[Buzzer & Sound], connect the sound input to the speaker, and then confirm if the input sound comes out through the speaker or not.
- (2) Release the check on [Line-in/MIC bypass to speaker] in the XGT Panel start menu [Settings]-[Buzzer & Sound].
- (3) Microphone with power not applied like ear microphone does not accept the sound input.

1.4. Display Problem of Figure and Object

The shape of object is not shown or the number or character value which has to be shown is not shown.

Phenomenon: The shape of object is not shown or the number or character value which has to be shown is not shown.

<Cause>

(1) The connection with PLC connected with each project is disconnected or NAK occurs.

<Solution>

- (1) When the communication is executed at first, Check the cable connected with PLC is OK or not.
- (2) If object where the offset is set is not shown, check whether address range is exceeded or not.
- (3) In case that communication is not OK, when communication is abnormal, the following message shows up in the XGT Panel.

Object type	Phenomenon
Bit Switch	The switch is expressed but it doesn't work.
Word Switch	The switch is expressed but it doesn't work.
Change Screen Switch	The switch is expressed but it doesn't work.
Special Switch	The switch is expressed but it doesn't work.
Multi Switch	The switch is expressed but it doesn't work.
Bit Lamp	Image is not shown.
Word Lamp	Image is not shown.
N-State Lamp	Image is not shown.
Clock	Present time is shown.
Bit Message	Message is not shown. When designating the background image, image is shown as it is.
Word Message	Message is not shown. When designating the background image, image is shown as it is.
Numeric Display	The value is not shown. When designating the background image, image is shown as it is.
Numeric input	The value is not shown. When designating the background image, image is shown as it is.
Text Display	Character string is not shown. When designating the background image, image is shown as it is.
Text Input	Character string is not shown. When designating the background image, image is shown as it is.
Bit Window	The window screen set in the object is not shown. But if communication is set with other object in the same window screen, it can be shown by that object.
Word Window	The window screen set in the object is not shown. But if communication is set with other object in the same window screen, it can be shown by that object.
Bit Part	The part screen set in the object is not shown. But if communication is set with other object in the same part screen, it can be shown by that object.
Word Part	The part screen set in the object is not shown. But if communication is set with other object in the same part screen, it can be shown by that object.
Animation	Animation is not shown.
Bar Graph	Graph is not shown. When designating the background image, image is shown as it is.
Pie Graph	Graph is not shown. When designating the background image, image is shown as it is.
Meter Graph	Graph is not shown. When designating the background image, image is shown as it is.
Closed Graph	Graph is not shown. When designating the background image, image is shown as it is.
Trend Graph	X, Y axis is shown normally but trend axis is not normally shown. When designating the background image, image is shown as it is.

Appendix 1. Troubleshooting

Object type	Phenomenon
History Alarm Viewer	Change doesn't occur. When communication is abnormal, alarm occurs because it can't know the status of alarm target device. But previous alarm data shows up as it is.
Data list	Value is not shown. Lattice of viewing data list of object is shown as it is.
Logging Viewer	Change doesn't occur. When communication is normal, the recorded log data is shown normally. But, log data is shown as # when communication is abnormal.
Navigator	Change doesn't occur. Because it shows the group of alarm already developed, though communication is abnormal, if it has alarm data already developed, it shows the name of group where each alarm is included.

The number indication object value is shown as # or ~.

Phenomenon: The number indication object value is shown as # or ~.

(Same phenomenon occurs at the number input device, viewing data list, and viewing logging)

<Cause>

(1) This happens when digit is not correct or type is not BCD.

<Solution>

- (1) When the number to be expressed exceeds the number set in the object, # is expressed. In case of this, set the digit largely and after download again, execute program again.
- (2) When the numeric display object is expressed as BCD type, the data whose type is not BCD is expressed as ~. In case of this, adjust device value as BCD type.
- (3) This phenomenon occurs at the data list object, numeric input, numeric display device, and logging viewer.

After switching the screen, the previous screen remains for a few minute.

Phenomenon: After switching the screen, when there is no background or image in the part or number indication device, the previous screen remains for a few minute because of change of part.

< Cause >

(1) After switching the screen, when connection is set up multiply or communication time-out occurs, the screen of previous part remains in some object.

<Solution>

(1) It is normal status. In case that multiple connection or communication is not good, when switching the screen, the remains of previous screen can occur during the time-out hour.

The folded object doesn't sequentially show up.

Phenomenon: The number under the data list shows up above data list.

< Cause >

(1) The device value is expressed at the top of object screen.

<Solution>

(1) It is normal status. The folded window or part object is not included in screen, regardless of sequence of drawing, the object changed recently is expressed at top of screen. So if possible, do not fold the object in screen.

The object always shows up above the figure.

Phenomenon: I downloaded the figure above the object in XP-Builder, but the object always shows up above the figure.

< Cause >

(1) In XGT Panel, The object always shows up above the figure.

<Solution>

(1) It is normal status. The object always shows up above figure in the XGT Panel.

Live image player doesn't show the camera screen.

Phenomenon: XP-Builder deployed live image player on the screen and performed download, but the area of live image player is displayed in blue or black color when starting monitoring.

<Cause>

(1) In case of being displayed in blue color, it means the camera-related function is not working in normal condition owing to software problem. In case of being displayed in black color, it means the function is in a normal condition, but camera is wrongly connected.

<Solution>

(1) In case of being displayed in blue color, please update iXP-Runtime again. If there still exists the same problem, please consult the A/S Center nearby. In case of being displayed in black color, please check for the cable connected with camera on the device. It may be a faulty connection between camera and cable or between iXP and cable.

Pop up window doesn't show camera screen.

Phenomenon: In the XP-Builder, the user deployed live image player on the pop up window (Nominating as global window or window object), but it doesn't show camera screen.

<Cause>

(1) Camera object is displayed only through a single object on the whole screen. That is, if the image started to be displayed on window screen, the live image player on the other screen such as basic screen doesn't display any more. Live image play is also displayed through an object only. Likewise, if the image is being played, the other live image player object doesn't play.

<Solution>

(1) Please touch the special switch for pause among those connected with the object of live image player now under play, and then start playing by pushing the special switch for start placed on the desired screen.

Appendix 1. Troubleshooting

Live image is not recorded.

Phenomenon: The user designated the record start device in the XP-Builder, and downloaded it, and turn the device On, but it is not recorded.

<Cause>

Some causes may lead to such situation as follow;

- (1) Please check for the connection of communication between Record Start device and iXP.
- (2) Please check that the storage device designated as record file storage path on the project property storage device settings is properly mounted on the actual device.
- (3) Be sure to check for any room in the designated storage device.
- (4) Please check that the number of recorded files stored in the designated storage device should not exceed the number of maximum record file designated in the project property special device setting window.
- (5) The user may watch the image input from the current camera and carry out recording simultaneously, but may not play the recorded live image and carry out recording simultaneously. That is, please try recording again with the play of live image stopped.

<Solution>

- (1) You can confirm through the device with applicable error number from which cause such failure of recording took place. Device with error number falls under the next word of the state device. That is, if you designated the state device as HW00, HW01 represents the device with error number. In the case of troubles related with the afore-mentioned cause, you can check it through the device with error number as follow;
 - 1: Record file path cannot be created (Required to check the storage device is mounted)
 - 2: Currently live image is being played (Required to record after stopping the live image play)
 - 3: Already under recording at present (Required to record after checking the recording under process is finished)
 - 4: Being in excess of the designated number of maximum files (Required to record after erasing of backing up the live image file already recorded)
 - 5: Insufficient room in the designated storage device. (Required to record after erasing of backing up the live image file already recorded)
 - 6: Video file storage path is not designated in the XP-Builder.
 - 7: Currently file cannot be created in the storage device.

1.5. Communication Problem

It seems that communication does not work.

Phenomenon: On the screen where the object is not many, communication works but when you move the screen where the object is many, timeout occurs.

< Cause >

- (1) In the device setting, the communication time-out is set to be too short.

<Solution>

- (1) It occurs because timeout is set much smaller than sum of request time of communication data and response time from PLC. In the device setting at the XP-Builder, after setting communication time out to be big, download program and execute again.

It seems that communication doesn't work.

Phenomenon: Communication doesn't work.

< Cause >

- (1) Communication setting or cable may be not normal.

<Solution>

- (1) In case of RS-232C, check whether connection setting is normal or not in XP-Builder.
- (2) In case of RS-422/485, check whether station and communication connection setting is normal or not.
- (3) If 1), 2) is normal, do diagnosis about PLC-RS232C, PLC-RS485/422 at the Serial diagnosis screen of device menu. Refer to the [Device manual ch.5.6 Serial Communication Diagnosis]
- (4) If 3) is normal, check whether connection cable has error or not.
- (5) In case of Ethernet, check the port and IP setting about relative PLC.



Caution

- ▶ Before trial operation of the product, be sure to check if a normal communication is available between XGT Panel and the subject device of control

1.6. CF/SD/USB Removal of Memory Card

When removing the CF/SD/USB memory card, device is stopped for some times.

Phenomenon: This happens when doing data backup including logging, recipe.

< Cause >

(1) This happens because memory card is removed when doing data backup.

<Solution>

- (1) If possible, when monitoring XGT Panel, do not remove the memory card and after going out to the waiting screen, execute the removing.
- (2) Inescapably you have to remove it during the operation, remove when backup does not occur. If the above phenomenon occurs, it works normally after about 10 seconds.
- (3) In case of USB memory, please remove it when the LED of USB external memory is not flickering.
- (4) In case of CF and SD memory cards, please remove it if LED is Off after the safety removal switch is turned On.



Caution

- ▶ If you force to remove the data during the storage of data in the external memory, file may not be stored in a normal condition or external memory may suffer from damage.

1.7. Error Message during Execution of Program

In case that problems occur during execution of XGT Panel including the start of device, diagnosis of device and environment setting, project download, monitoring of control device, and error messages occur as type of box. At this time the message indicates the code made by 4 digit number. The front 2 number indicate code of object and work, the rear 2 number is message number. In case that the present error message is indicated as [0101], an error message occurs when doing diagnosis about the status of NVRAM. When an error message occurs, refer to the row's number and sequence and find the category of reason and measure.

Object	Error code		Occurrence location	Error message	Reason and measure
	Type	Address			
Device diagnosis	0x01	0x01	XGT Panel	NVRAM Data Access ... FAILED!	Failed to check whether backup memory is normal or not. If this symptom is repeated, contact the near Customer Service Center.
		0x02	XGT Panel	BATTERY STATUS ... NOT GOOD!	Backup data is not valid. If this symptom is repeated when turning power off and on, remove XGT Panel's power and exchange the battery.
		0x03	XGT Panel	Write Operation FAILURE!	The built-in Flash disk has an error. Contact the near Customer Service Center.
		0x04	XGT Panel	Read Disk Information Error!	The built-in Flash disk has an error. Contact the near Customer Service Center.
		0x05	XGT Panel	Write Operation FAILURE!	Check that CF card is empty, and equip CF card and test again. If same symptom is repeated, CF card or CF card slot of XGT Panel may have a problem.
		0x06	XGT Panel	Read Disk Information Error!	Check that CF card is empty, and equip CF card and test again. If same symptom is repeated, CF card or CF card slot of XGT Panel may have a problem.
Device setting	0x02	0x01	XGT Panel	Invalid timeout value.	You inputted the wrong time which is not within backlight setting time range. Input the effective time.
		0x02	XGT Panel	Not found XGT Panel configuration file.	There is no setting information data of XGT Panel. If this symptom is repeated when turning power off and on, contact the near Customer Service Center.
		0x03	XGT Panel	Please enter an integer between 0 and 255.	When setting IP, the values within 0~255 are effective. Input the value within the above range.
Viewing device information	0x03	0x01	XGT Panel	No project in XGT Panel.	Now, there is no downloaded project so you can't see connection information. Download the project from XP-Builder.

Appendix 1. Troubleshooting

Object	Error code		Occurrence location	Error message	Reason and measure
	Type	Address			
XGT Panel Update	0x04	0x01	XGT Panel	Failed to Start engine. Please update engine again.	Because of update error or Flash disk error, program can't be executed. If you can update, redo the above procedure. If you can't, contact the near Customer Service Center.
Switch	h05	h01	XGT Panel	Invalid password.	There is password in the each object. When editing the project downloaded in the present device, input the designated password at the project property information.
Number indication device/ Number input device	0x06	h01	XGT Panel	Can't write Data.	Because of communication error, the value can't be inputted. Check the communication status and input again.
		h02	XGT Panel	No input Data.	You tried to input with no value. Input the value
		0x03	XGT Panel	Exceeded the max length.	You exceed the maximum length to input.
		0x04	XGT Panel	Exceeded the minimum Value.	You exceed the maximum value to input.
		0x05	XGT Panel	Exceeded the maximum Value.	You exceed the minimum value to input.
		0x06	XGT Panel	Invalid at Input Case.	When you input the value, input can't be done because of wrong input. Check the input condition of each object in the Builder and input again.
Lamp	0x07			None	
Character indication device/ Character input device	0x08			None	
Message	0x09			None	
Clock	0x0A			None	
Animation	0x0B			None	
Graph	0x0C			None	
Window	0x0D			None	
Part	0x0E			None	
History alarm	0x0F			None	
Flow alarm	0x20			None	
System alarm	0x21			None	
Scheduler related	0x22			None	
Recipe related	0x23			None	
Logging related	0x24			None	

Appendix 1. Troubleshooting

Object	Error code		Occurrence location	Error message	Reason and measure
	Type	Address			
Data list	0x25	None			
Project download	0x26	0x00	XGT Panel	Abnormal send-payload. Please download project again.	Communication status is abnormal. Check the connection of communication cable.
		0x01	XP Builder	There's not Password File.	This message shows up when making it newly because there is no password setting file in the device. When making it newly, it is initialized with no password.
		0x02	XP Builder	Failed to Create Password File.	It make new password setting file when there is no password setting file. But downloading is stopped when it fails to make this file because of device error. If this problem is repeated, Contact the near Customer Service Center.
		0x03	XP Builder	Invalid Backup Media.	Communication status is abnormal. Route information is not correct to save project data. If this problem is repeated, Contact the near Customer Service Center.
		0x04	XP Builder	Failed to Create version File.	In case that the version information file doesn't exist in the device, that file is made newly. In case that the device has error and fails to make that file, download is stopped. If this problem is repeated, Contact the near Customer Service Center.
		0x05	XP Builder	File Size Error.	There is version information file. In case that because of error of device, it fails to read version information, because the device doesn't know version, download is stopped. If this problem is repeated, Contact the near Customer Service Center.
		0x06	XP Builder	Failed to get Project ID.	In case of not reading file where project property is included, download is stopped. If this problem is repeated, Contact the near Customer Service Center.
		0x07	XP Builder	Failed to read history alarm data.	In case of not reading information about alarm history because of error of NVRAM, download is stopped. If this problem is repeated, Contact the near Customer Service Center.

Appendix 1. Troubleshooting

Object	Error code		Occurrence location	Error message	Reason and measure
	Type	Address			
		0x08	XP Builder	Failed to read CF Card information.	Project is set to store data at CF card equipped at device. By the way, now it can't read information about CF card. Check the installation status of CF card and if it is normal, check the CF card. If this problem is repeated, contact Customer Service Center.
Project download	0x26	0x09	XP Builder	Failed to read USB information.	Project is set to store data at USB storage device equipped at device. By the way, now it can't read information about USB storage device. Check the installation status of USB storage device and if it is normal, check USB storage device. If this problem is repeated, contact Customer Service Center.
		0x0A	XP Builder	Failed to read Flash memory information.	In case that it can't know information about memory status, download is stopped. If this problem is repeated, contact Customer Service Center.
		0x0B	XP Builder	Failed to clear Temp Directory.	In case that because of error of Flash Disk, it can't delete the directory made temporarily for download because of error of Flash Disk, download is stopped. If this problem is repeated, contact Customer Service Center.
		0x0C	XGT Panel	Failed to delete Font File. Please reboot XGT Panel.	In case that it fail to delete the font file of previous project because of error of XGT Panel, download is stopped. If this problem is repeated, contact Customer Service Center.
		0x0D	XGT Panel	Failed to delete Image File. Please reboot XGT Panel.	In case that it fail to delete the image file of previous project because of error of XGT Panel, download is stopped. If this problem is repeated, contact Customer Service Center.
		0x0E	XGT Panel	Failed to delete Sound File. Please reboot XGT Panel.	In case that it fail to delete the sound file of previous project because of error of XGT Panel, download is stopped. If this problem is repeated, contact Customer Service Center.
		0x0F	XGT Panel	There's no downloaded project. It needs to download whole project	It can't download part or fixed part in case there is no downloaded project. In case of this, download again. If this problem is repeated, contact Customer Service Center.

Appendix 1. Troubleshooting

Object	Error code		Occurrence location	Error message	Reason and measure
	Type	Address			
		0x10	XP Builder	Backup path is invalid. Please check the path that project is downloaded.	When user change the storage location of project data including image and font, if there is not respective routine, it make newly. By the way, download is stopped in case it fails to make newly. When it is designated as CF card, it can occur in case CF card is not installed. If this problem is repeated and not referred in the above, contact Customer Service Center.
		0x11	XGT Panel	Failed to delete previous project archive. Please reboot XGT Panel.	The project backup file downloaded already can be deleted because of error of XGT Panel. Reboot XGT Panel. If this problem is repeated, contact Customer Service Center.
Project download	0x26	0x12	XGT Panel	Failed to delete past project data files. Please download project again.	When downloading, the log data area in the NV-RAM is initialized in case of selecting previous project's the monitor data deletion option. By the way, in case of failing this, downloading is stopped. If this problem is repeated, contact Customer Service Center.
		0x15	XGT Panel	Failed to initialize LOGGING area in NV RAM. Please download project again.	When downloading, the log data area in the NV-RAM is initialized in case of selecting previous project's the monitor data deletion option. By the way, in case of failing this, downloading is stopped. If this problem is repeated, contact Customer Service Center.
		0x16	XGT Panel	Failed to initialize RECIPE area in NV RAM. Please download project again.	When downloading, the alarm history in the NV-RAM is initialized in case of selecting the previous project's monitor data deletion option. By the way, in case of failing this, downloading is stopped. If this problem is repeated, contact Customer Service Center.
		0x17	XGT Panel	Failed to initialize ALARM area in NV RAM. Please download project again.	The downloaded font file is moved into original storage location but when this fails, downloading is stopped. If this symptom is repeated, contact Customer Service Center.
		0x18	XGT Panel	Failed to install font files. Please download project again.	The project data is divided into several files according to the contents but when this fails, downloading is stopped. If this symptom is repeated, contact Customer Service Center.
		0x19	XGT Panel	Failed to unmarshall download file. Please download project again.	The data divided according to the contents is moved to the original storage location but when this fails, downloading is stopped. If this symptom is repeated, contact Customer Service Center.

Appendix 1. Troubleshooting

Object	Error code		Occurrence location	Error message	Reason and measure
	Type	Address			
		0x1A	XGT Panel	Failed to install new project data files. Please download project again.	The downloaded project is not installed normally because of error of the Flash Disk. Download the project again. If this symptom is repeated, contact Customer Service Center.
		0x1B	XGT Panel	Failed to merge data files. Please download project again.	The downloaded project zip file is moved to the original storage location but when it fails, downloading is stopped. If this symptom is repeated, contact Customer Service Center.
		0x1C	XGT Panel	Failed to save new project archive. Please download project again.	There is a program to reboot engine program after downloading in the device but when it fails, this message shows up. But because the downloading is completed if you reboot engine directly, it works normally. The program name to reboot is startup.exe and it can be installed by engine upgrade function.
Project download	0x26	0x1D	XGT Panel	Failed to XGP Panel startup program. Please update XGT Panel Software.	It can't find software to reboot XGT Panel. Update the XGT Panel.
		0x1E	XGT Panel	Project data is not downloaded. Please download project again.	The project data was not downloaded normally because of communication error. Check the connection status of communication cable and If this symptom is repeated, contact Customer Service Center.
		0x1F	XGT Panel/ XP-Builder	Failed to read Version information file. Please download project again.	There is version information file but when it can't read file normally because of the device error, downloading is stopped because it doesn't know version. If this symptom is repeated, contact Custom Service Center
Project download from USB storage device	0x27	0x51	XGT Panel	Cannot find project data in USB Storage	There is no USB or device status of USB is not good or project is not saved properly.
		0x52	XGT Panel	Project information file is not in USB Storage.	The project is not saved normally in the USB. Check whether there is XP_Project folder and [project name].inf in the USB or not.
		0x53	XGT Panel	Failed to read project information file.	It can't read project information file because the project is not saved in the USB normally. Save the project again from XP-Builder to the USB.

Appendix 1. Troubleshooting

Object	Error code		Occurrence location	Error message	Reason and measure
	Type	Address			
		0x54	XGT Panel	Device type is not matched.	The connected device type is not same as the device type set in the project in the USB. In case of this, project can't be downloaded into the device. Edit the project again or download according to the connected device.
		0x55	XGT Panel	Cannot read user password.	Information about the password can't be read because of the device error. If this symptom is repeated, contact Customer Service Center.
		0x56	XGT Panel	Password is not matched.	When saving the project, the password inputted by user is not same as present connection password. Input correct password and save the project.
Project download from USB storage device	0x27	0x57	XGT Panel	Cannot read XGT Panel software version.	There is version information file but when it can't read file normally because of the device error, downloading is stopped because it doesn't know version. If this symptom is repeated, contact Customer Service Center.
		0x58	XGT Panel	XGT Panel software is old version. Please update XGT Panel.	The version of XP-Builder where project is saved is not compatible with present XGT Panel. Update the XGT Panel.
		0x58	XGT Panel	XP-Builder is old version. Please update XP-Builder.	The version of XP-Builder where project is saved is not compatible with present XGT Panel. Update the XGT Panel.
		0x59	XGT Panel	Cannot read download data format version.	There is storage structure version information file. But when it can't read this file because of the device error, downloading is stopped because it doesn't know the version. If this symptom is repeated, contact Customer Service Center.
		0x5A	XGT Panel	Download data format version is not matched. Please update XGT Panel.	Data storage type is not correct. Update XGT Panel.
		0x5A	XGT Panel	Download data format version is not matched. Please update XP-Builder.	Data storage type is not correct. Update the XP-Builder.
		0x5B	XGT Panel	Data file path is invalid.	There is no project data file at designated location. Check the connection status of USB and if there is no error, save the project to USB again.

Appendix 1. Troubleshooting

Object	Error code		Occurrence location	Error message	Reason and measure
	Type	Address			
		0x5C	XGT Panel	Download file name length is invalid.	The name of project data file is not saved correctly. Save the project at the USB again. If this symptom is repeated, contact Customer Service Center.
		0x5D	XGT Panel	Cannot find download file.	The project data file can't be found. Save the project data file at the USB again. When this symptom is repeated, check the USB. If there is no error, contact Customer Service Center.
		0x5E	XGT Panel	Download file size is invalid.	The project data file is not saved correctly. Save the project data file at the USB again. When this symptom is repeated, check the USB. If there is no error, contact Customer Service Center.
Project download from USB storage device	0x27	0x5F	XGT Panel	Cannot find project backup file.	The project backup file which should be downloaded is not downloaded because of communication error. Download again.
		0x60	XGT Panel	Project backup file size is invalid.	The project backup file is saved incorrectly. Save the project at the USB storage equipment again. When this symptom is repeated, check the USB storage equipment and if the USB is normal, contact Customer Service Center.
		0x61	XGT Panel	Font file name length is invalid.	The font file's name is saved incorrectly. Save the project in the USB again. If this symptom is repeated, contact Customer Service Center.
		0x62	XGT Panel	Font file is not downloaded.	The font file which is needed for project is not saved in the USB storage equipment. Save the project in the USB. If this symptom is repeated, contact Customer Service Center.
		0x63	XGT Panel	Font file size is invalid.	The font file is not saved correctly. Save the project at the USB. Save the project at the USB. If this symptom is repeated, check the USB and if the USB is normal, contact Customer Service Center.
		0x64	XGT Panel	Cannot unmarshall download file.	The data can't be analyzed because the project data file is not saved correctly. Save the project at the USB again. If this symptom is repeated, check the USB and if the USB is normal, contact Customer Service Center.
		0x65	XGT Panel	Cannot delete previous project data.	The data of the project can't be deleted because of device error. If this symptom is repeated, check the USB and if the USB is normal, contact Customer Service Center.

Appendix 1. Troubleshooting

Object	Error code		Occurrence location	Error message	Reason and measure
	Type	Address			
		0x66	XGT Panel	Cannot move new font files.	Downloaded font file is moved to the original storage location. But when it fails, the downloading is stopped. If this symptom is repeated, contact Customer Service Center.
		0x67	XGT Panel	Cannot move new project data files.	The project data classified according to the content is moved to the original storage location. But when it fails, the downloading is stopped. If this symptom is repeated, contact Customer Service Center.
		0x68	XGT Panel	Cannot move project backup file.	The downloaded project zip data is moved to the original storage location. But when it fails, the downloading is stopped. If this symptom is repeated, contact Customer Service Center.
XGT Panel booting	0x28	0x01	XGT Panel	Previous instance is not terminated.	XGT Panel software was already started. Reboot the device. If this symptom is repeated, contact Customer Service Center.
		0x02	XGT Panel	Start Server Fail. Restart XGT Panel	The XGT Panel software can't initialize the communication status normally. Check the communication status again. If this symptom is repeated when communication is normal, contact Customer Service Center.
		0x03	XGT Panel	Failed to Start Echo Server.	The XGT Panel software can't initialize the communication status normally. Check the communication status again. If this symptom is repeated when communication is normal, contact Customer Service Center.
		0x04	XGT Panel	Failed to accept connection.	The XGT Panel software can't initialize the communication with the XP-Builder normally. Check the communication status again. If this symptom is repeated when communication is normal, contact Customer Service Center.

Appendix 1. Troubleshooting

Object	Error code		Occurrence location	Error message	Reason and measure
	Type	Address			
		0x05	XGT Panel	Failed to rename UpdateNew.exe	In the present XGT Panel the new updated XGT Panel software's name can not be changed. After rebooting the XGT Panel, update again. When rebooting, if you can't start engine, delete \\FlashDisk\LSISProduct\UpdateNew.exe in the XGT Panel. Then if you touch Update.exe and execute the XGT Panel, it can be update mode. Try update again. If this symptom is repeated, contact Customer Service Center
		0x06	XGT Panel	Failed to Delete Update.exe.	The new module is downloaded by the XGT Panel update but the previous module is not deleted. Reboot the device. If the XGT Panel software is not started normally, touch \\FlashDisk\LSISProduct\Update.exe in the XGT Panel. At this time, if XGT is set as update mode, update again. If this symptom is repeated, contact Customer Service Center.
Communication between other XP Builder-XGT Panel	0x29	0x30	XGT Panel	Failed to modify password file.	The device connection password can't be modified because of error of Flash Disk of XGT Panel. Reboot the device. If this symptom is repeated, contact Customer Service Center.
		0x31	XGT Panel	Password-related command transmission payload error	It failed to set and modify password because of communication status error. If this symptom is repeated, contact Customer Service Center.
		0x32	XGT Panel	There is no XGT Panel connection setting file.	The connection setting file of XGT Panel can't be found.
		0x33	XGT Panel	Modified content can't be saved in the XGT Panel connection setting file.	The modified information can't be saved at the connection setting file of XGT Panel. If this symptom is repeated, contact Customer Service Center.
		0x34	XGT Panel	Failed to set the time	The XGT Panel's time can't be set. If this symptom is repeated, contact Customer Service Center.
XGT panel SW update	0x30	0x21	XGT Panel/ XP-Builder	Failed to Create Initialized Module Version File.	Because the each module version information can't be read because of XGT Panel's error, it failed to initialize. If this symptom is repeated, contact Customer Service Center.

Appendix 1. Troubleshooting

Object	Error code		Occurrence location	Error message	Reason and measure
	Type	Address			
		0x22	XGT Panel/ XP-Builder	Module version file size is invalid.	The each module version information can't be read because of XGT Panel's error. If this symptom is repeated, contact Customer Service Center.
		0x23	XGT Panel/ XP-Builder	Can't Read module version file.	The each module version information can't be read because of XGT Panel's error. If this symptom is repeated, contact Customer Service Center.
		0x24	XP-Builder	There's no file to download.	The version information list to update is empty. Check the module folder newly designated at XP-Builder and if there is no error, download XGT Panel module and try update again. If this symptom is repeated, contact Customer Service Center.
		0x25	XP-Builder	Downloaded file is not Module to download.	The wrong file which is not in the new module list of XGT Panel is downloaded. Try update of XGT Panel again. If this symptom is repeated, contact Customer Service Center.
XGT panel SW update	0x30	0x26	XGT Panel	Not enough space in flash memory.	The space to copy new module in XGT Panel is not enough. After deleting the unnecessary file or backing up the previous file to the movable storage equipment, try update again. If this symptom is repeated after deleting, contact Customer Service Center.
		0x27	XGT Panel	Failed to Copy module ~.dll	The new module is not installed because of XGT Panel's error. After rebooting the device, touch \\FlashDisk\LSISProduct\Update.exe and set the device as update mode. Then update again. If this symptom is repeated, contact Customer Service Center.
		0x28	XGT Panel	Failed to Start Engine. Please update engine again.	To reboot the engine is not available because of wrong file which is developed by downloading wrong module or communication error. Touch \\FlashDisk\LSISProduct\Update.exe and set the device as update mode. Then update again. If this symptom is repeated, contact Customer Service Center.

Appendix 1. Troubleshooting

Object	Error code		Occurrence location	Error message	Reason and measure
	Type	Address			
		0x2A	XGT Panel	Failed to write Data to Module version File.	It is failed to record the version information during update of XGT Panel. If this symptom is repeated, contact Customer Service Center.
		0x2B	XGT Panel	There's no downloaded file.	To reboot the engine is not available because of wrong file which is developed by downloading wrong module or communication error. Touch \\FlashDisk\LSISProduct\Update.exe and set the device as update mode. Then update again. If this symptom is repeated, contact Customer Service Center.
		0x2C	XGT Panel	(improper communication command) Current state is not authorized.	To reboot the engine is not available because of wrong file which is developed by downloading wrong module or communication error. Touch \\FlashDisk\LSISProduct\Update.exe and set the device as update mode. Then update again. If this symptom is repeated, contact Customer Service Center.
XGT panel SW update	0x30	0x2D	XGT Panel	(improper communication command) A module to download is not listed up yet.	To reboot the engine is not available because of wrong file which is developed by downloading wrong module or communication error. Touch \\FlashDisk\LSISProduct\Update.exe and set the device as update mode. Then update again. If this symptom is repeated, contact Customer Service Center.
		0x2E	XGT Panel	Failed to Initialize Update program.	XGT can't be set as update mode because of XGT Panel error. After downloading new XGT Panel module through homepage, etc., copy UpdateNew.exe file among new module to the \\FlashDisk\LSISProduct\ directory of XGT Panel through the movable storage equipment. Then reboot the XGT Panel and go update mode and update again. If this symptom is repeated, contact Customer Service Center.

Appendix 2. Dimension (Unit: mm)

(1) iXP70-TTA/AC (DC)

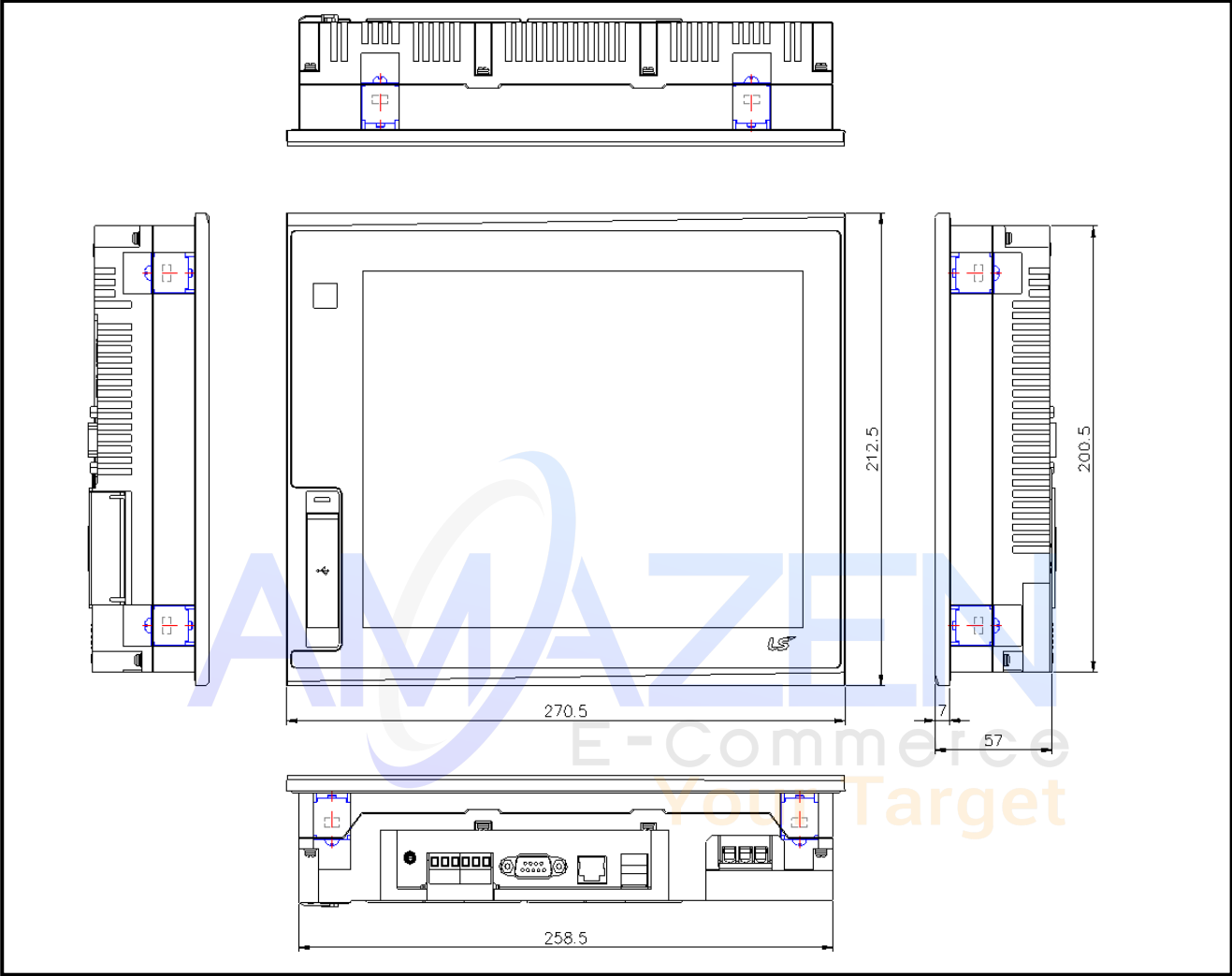

Appendix 2. Dimension

(2) iXP80-TTA/AC (DC)

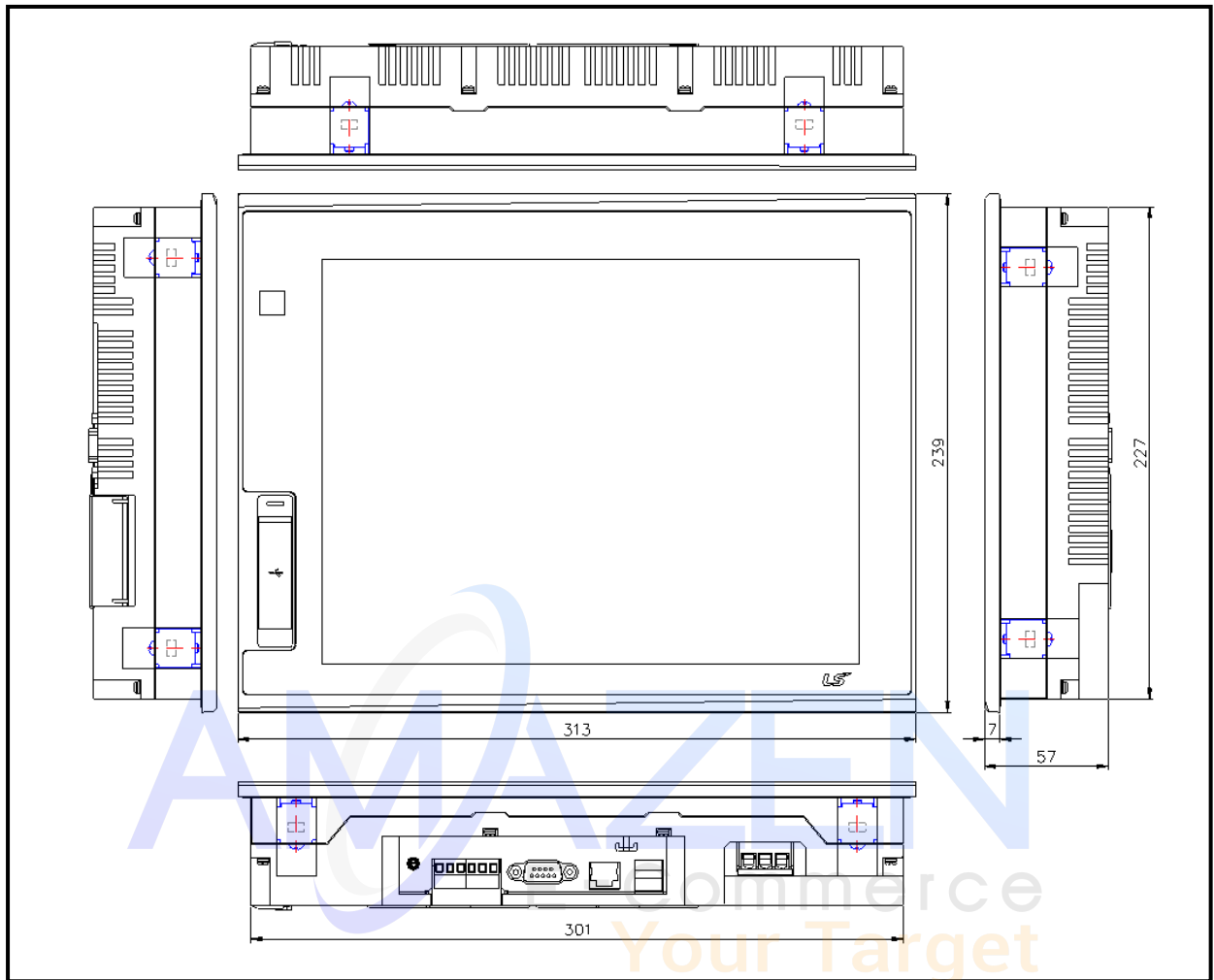

(3) iXP90-TTA/AC (DC)

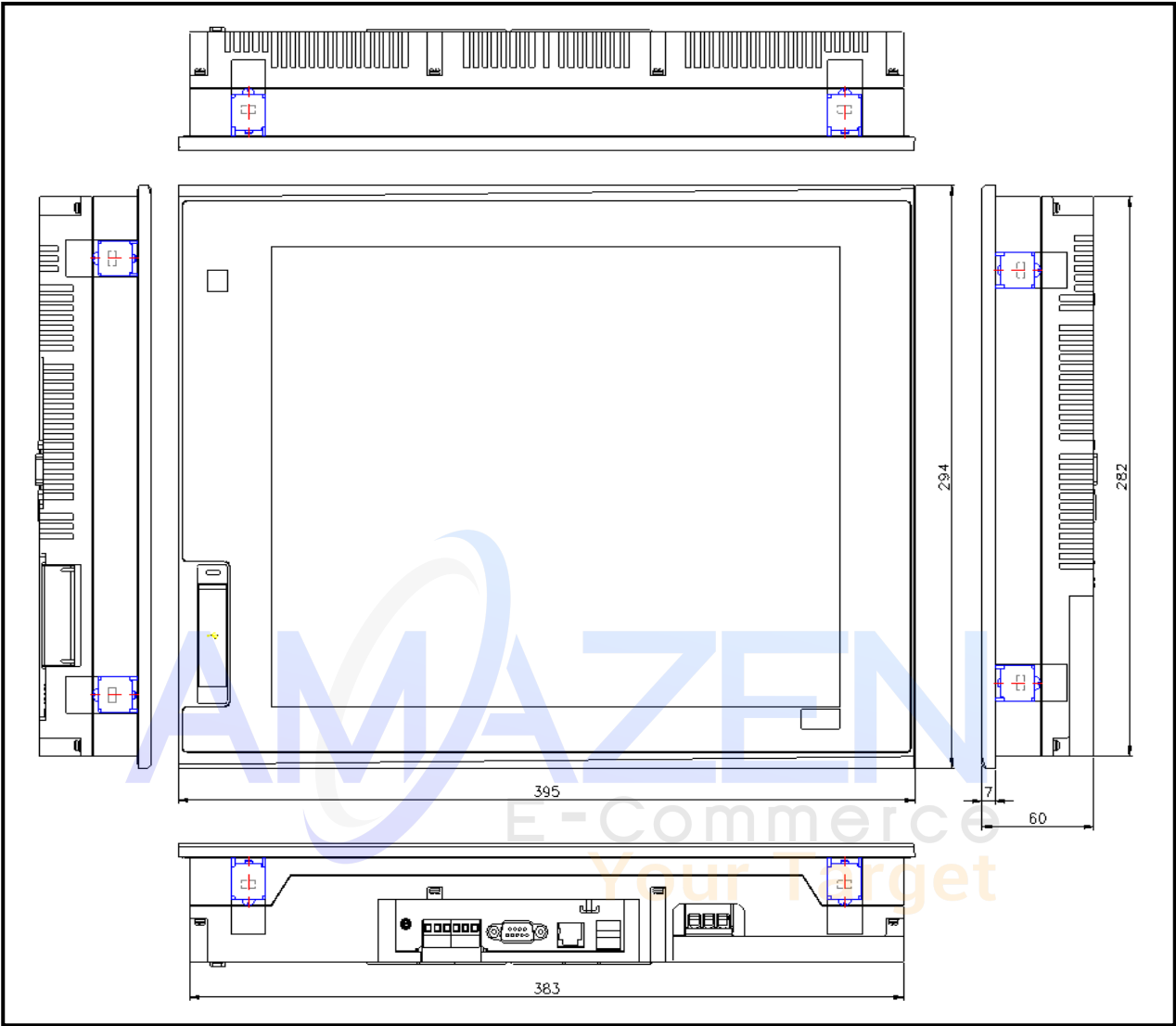

Warranty

1. Warranty Period

The product you purchased will be guaranteed for 18 months from the date of manufacturing.

2. Scope of Warranty

Any trouble or defect occurring for the above-mentioned period will be partially replaced or repaired. However, please note the following cases will be excluded from the scope of warranty.

Any trouble attributable to unreasonable condition, environment or handling otherwise specified in the manual,

Any trouble attributable to others' products,

If the product is modified or repaired in any other place not designated by the company,

Due to unintended purposes

Owing to the reasons unexpected at the level of the contemporary science and technology when delivered.

Not attributable to the company; for instance, natural disasters or fire

3. Since the above warranty is limited to HMI unit only, make sure to use the product considering the safety for system configuration or applications.

Environmental Policy

LS Industrial Systems Co., Ltd supports and observes the environmental policy as below.

Environmental Management

LS Industrial Systems considers the environmental preservation as the preferential management subject and every staff of LS Industrial Systems use the reasonable endeavors for the pleasurable environmental preservation of the earth.

About Disposal

LS Industrial Systems' PLC unit is designed to protect the environment. For the disposal, separate aluminum, iron and synthetic resin (cover) from the product as they are reusable.



LS values every single customers.

Quality and service come first at LSIS.

Always at your service, standing for our customers.



■ **HEAD OFFICE**

LS tower, Hogye-dong, Dongan-gu, Anyang-si, Gyeonggi-do 1026-6,
Korea <http://www.lsis.com>
Tel : (82-2)2034-4870/Fax : 82-2-2034-4648 e-mail : cshwang@lsis.com

■ **LSIS Tokyo Office _ Tokyo, Japan**

Address: 16FL. Higashi-Kan. Akasaka Twin Tower 17-22,
Akasaka.Monato-ku Tokyo 107-8470. Japan
Tel : 81-3-3582-9128/Fax : 81-3-3582-2667 e-mail : jschuna@lsis.com

■ **LSIS(ME) FZE _ Dubai, U.A.E.**

Address : Jafza View Tower Lob 19, Room 205 Along Sheikh Zayed
Road Jebel Aali Free Zone Dubai, United Arab Emirates
Tel : 971-4-886-5360/Fax : 971-4-886-5361 e-mail : jungyongqi@lsis.com

■ **LSIS Shanghai Office _ Shanghai, China**

Address : Room E-G. 12FL Hiamin Empire Plaza. No.726. West.
Yan'an Road Shanghai 200050. P.R. China e-mail : liyong@lsis.com.cn
Tel : 86-21-5237-9977(609)/Fax : 89-21-5237-7189

■ **LSIS Beijing Office _ Beijing, China**

Address : B-Tower 17FL. Beijing Global Trade Center B/D. No. 36.
East BeisanHuan-Road. DongCheng-District. Beijing 100013. P.R. China
Tel : 86-10-5825-6027(666)/Fax : 86-10-5825-6028 e-mail : xunmi@lsis.com.cn

■ **LSIS Guangzhou Office _ Guangzhou, China**

Address : Room 1403.14FL. New Poly Tower.
2 Zhongshan Liu Road.Guangzhou.P.R China
Tel : 86-20-8328-6754/Fax : 86-20-8326-6287 e-mail : chenxs@lsis.com.cn

■ **LSIS Chengdu Office _ Chengdu, China**

Address : 12FL. Guodong Buiding. No.52 Jindun
Road Chengdu.610041. P.R. China
Tel : 86-28-8612-9151(9226)/Fax : 86-28-8612-9236 e-mail : comysb@lsis.com

■ **LSIS Qingdao Office _ Qingdao, China**

Address : YinHe Bldg. 402 Room No. 2P Shandong Road,
Qingdao-City,Shandong-province 266071, P.R. China
Tel : 86-532-8501-6068/Fax : 86-532-8501-6057 e-mail : wangzy@lsis.com.cn

■ **LSIS Europe B.V.**

Address : 1st. Floor, Tupolevlaan 48, 1119NZ, Schiphol-Rijk, The Netherlands
Tel : +31 (0)20 654 1420/Fax : +31 (0)20 654 1429 e-mail : junshickp@lsis.com

■ **LSIS(Wuxi) Co., Ltd _ Wuxi, China**

Address : 102-A. National High & New Tech Industrial Development Area.
Wuxi. Jiangsu. 214028. P.R. China
Tel : 86-510-8534-6666/Fax : 86-510-8534-4078 e-mail : caidx@lsis.com.cn

■ **LSIS(Dalian) Co., Ltd. _ Dalian, China**

Address : No. 15. Liaohexi 3-Road. Economic and Technical Development zone.
Dalian 116600. China
Tel : 86-411-273-7777/Fax : 86-411-8730-7560 e-mail : cuibx@lsis.com.cn

※ LS Industrial Systems constantly endeavors to improve its product so that information in this manual is subject to change without notice.

© LSIS Co., Ltd 2013 All Rights Reserved.

2013. 11