

Bar Graphic Temperature Indicators

KN-1000B Series

INSTRUCTION MANUAL

TCD210153AB

Autonics

Thank you for choosing our Autonics product.

Read and understand the instruction manual and manual thoroughly before using the product.

For your safety, read and follow the below safety considerations before using.

For your safety, read and follow the considerations written in the instruction manual, other manuals and Autonics website.

Keep this instruction manual in a place where you can find easily.

The specifications, dimensions, etc are subject to change without notice for product improvement. Some models may be discontinued without notice.

Follow Autonics website for the latest information.

Safety Considerations

- Observe all 'Safety Considerations' for safe and proper operation to avoid hazards.
- ⚠ symbol indicates caution due to special circumstances in which hazards may occur.

⚠ Warning Failure to follow instructions may result in serious injury or death

01. Fail-safe device must be installed when using the unit with machinery that may cause serious injury or substantial economic loss. (e.g. nuclear power control, medical equipment, ships, vehicles, railways, aircraft, combustion apparatus, safety equipment, crime/disaster prevention devices, etc.)

Failure to follow this instruction may result in personal injury, economic loss or fire.

02. Do not use the unit in the place where flammable/explosive/corrosive gas, high humidity, direct sunlight, radiant heat, vibration, impact or salinity may be present.

Failure to follow this instruction may result in explosion or fire.

03. Install on a device panel to use.

Failure to follow this instruction may result in fire or electric shock.

04. Do not connect, repair, or inspect the unit while connected to a power source.

Failure to follow this instruction may result in fire or electric shock.

05. Check 'Connections' before wiring.

Failure to follow this instruction may result in fire.

06. Do not disassemble or modify the unit.

Failure to follow this instruction may result in fire or electric shock.

⚠ Caution Failure to follow instructions may result in injury or product damage

01. Use the unit within the rated specifications.

Failure to follow this instruction may result in fire or product damage

02. Use a dry cloth to clean the unit, and do not use water or organic solvent.

Failure to follow this instruction may result in fire or electric shock.

03. Keep the product away from metal chip, dust, and wire residue which flow into the unit.

Failure to follow this instruction may result in fire or product damage.

04. Check the polarity of the measurement input before wiring.

Failure to follow this instruction may result in explosion or fire.

Cautions during Use

- Follow instructions in 'Cautions during Use'. Otherwise, it may cause unexpected accidents.
- For connecting the power, use the crimp terminal (M3.5, max. 7.2 mm).
- 24 VDC≐ power supply should be insulated and limited voltage/current or Class 2, SELV power supply device.
- Keep away from high voltage lines or power lines to prevent inductive noise. Do not use near the equipment which generates strong magnetic force or high frequency noise.
- Install a power switch or circuit breaker in the easily accessible place for supplying or disconnecting the power.
- Use twisted pair wire for communication line.
- This unit may be used in the following environments.
 - Indoors (in the environment condition rated in 'Specifications')
 - Altitude Max. 2,000 m
 - Pollution degree 2
 - Installation category II

Ordering Information

This is only for reference, the actual product does not support all combinations. For selecting the specified model, follow the Autonics website.

K N - 1 ① ② ③ B

① Alarm output

0: No mark

2: 2 alarm

4: 4 alarm

② Option output

0: No mark

1: PV Transmission

4: Communication

③ Power supply

0: 100-240 VAC~ 50/60 Hz

1: 24 VDC≐

Product Components

- Product
- Instruction manual
- Bracket ×2
- Unit sticker ×1
- Connector (KN-10□□B: ×3, KN-12□□B: ×4, KN-140□B: ×4, KN-141□B: ×5, KN-144□B: ×5)

Software

Download the installation file and the manuals from the Autonics website.

■ DAQMaster

DAQMaster is comprehensive device management program. It is available for parameter setting, monitoring.

Specifications

Series	KN-1000B Series	
	AC voltage	DC voltage
Power supply	100 - 240 VAC~ 50/60 Hz	24 VDC≐
Allowable voltage range	90 to 110% of rated voltage	
Power consumption	≤ 6 VA	
Sampling period	• Thermocouple, RTD: 250 ms • Analog: 100 ms	
Input specification	Refer to 'Input Type and Using Range'.	
Digital input	Contact	• ON: ≤ 2 kΩ • OFF: ≥ 90 kΩ
	Non contact	• Residual voltage: ≤ 1.0 V • leakage current: ≤ 0.03 mA
	Outflow current	≈ 0.2 mA
Option output	Alarm	• 2 point relay: 250 VAC~ 3 A 1c • 4 point relay: 250 VAC~ 1 A 1a
	PV transmission	ISOLATED DC 4-20 mA (Load resistance: ≤ 600 Ω)
	RS485 comm.	Modbus RTU
Display type	7 Segment (red), Graph bar (green)	
Alarm output Hysteresis	1 to 999 digit	
Relay life cycle	Mechanical	• 2 point: ≥ 10,000,000 operations • 4 point: ≥ 20,000,000 operations
	Electrical	• 2 point: ≥ 100,000 operations (load resistance: 250 VAC~ 3 A) • 4 point: ≥ 500,000 operations (load resistance: 250 VAC~ 1 A)
Dielectric strength	Between input terminal and power terminal: 2,000 VAC~ 50/60 Hz for 1 min	
Vibration	0.75 mm amplitude at frequency of 5 to 55 Hz (for 1 min) in each X, Y, Z direction for 2 hours	
Insulation resistance	≥ 100 MΩ (500 VDC≐ megger)	
Noise immunity	± 2 kV square shaped noise (pulse width 1 μs) by noise simulator	
Memory retention	≈ 10 years (non-volatile semiconductor memory type)	
Ambient temperature	-10 to 50 °C, storage: -20 to 60 °C (no freezing or condensation)	
Ambient humidity	35 to 85%RH, storage: 35 to 85%RH (no freezing or condensation)	
Approval	CE ENEC	
Unit weight (packaged)	≈ 182 g (≈ 304 g)	

Communication Interface

■ RS485

Comm. protocol	Modbus 1.1 RTU
Maximum connection	32 units
Synchronous method	Asynchronous
Comm. method	Two-wire half duplex
Comm. effective range	≤ 1,200 m (≤ 700 m recommended)
Comm. speed	9,600 (default) / 4,800 / 2,400 / 1,200 bps (parameter)
Data bit	8 bit (fixed)
Parity bit	None (fixed)
Stop bit	1 bit (fixed)

Input Type and Using Range

Input type	Display	Using range (°C)	Using range (°F)	
K (CA)	tc 1	200 to 1350	-328 to 2,462	
K (CA)	tc 2	-199.9 to 999.9	-328 to 1,832	
J (IC)	tc - J	-199.9 to 800.0	-328 to 1,472	
E (CR)	tc - E	-199.9 to 800.0	-328 to 1,472	
T (CC)	tc - t	-199.9 to 400.0	-199.9 to 752.0	
B (PR)*	tc - b	100 to 1,800	212 to 3,272	
R (PR)	tc - r	0 to 1,750	32 to 3,182	
S (PR)*	tc - S	0 to 1,750	32 to 3,182	
N (NN)*	tc - n	-200 to 1,300	-328 to 2,372	
C (W5)*	tc - C	0 to 2,300	32 to 4,172	
L (IC)*	tc - L	-199.9 to 900.0	-328 to 1,652	
U (CC)*	tc - U	-199.9 to 400.0	-199.9 to 752.0	
Platinel II*	tc - P	0 to 1,390	32 to 2,534	
Cu50Ω*	cu 5 0	-199.9 to 200.0	-199.9 to 392.0	
Cu100Ω*	cu 1 0	-199.9 to 200.0	-199.9 to 392.0	
JPt100Ω	JP t 1	-199.9 to 600.0	-328 to 1,112	
DPt50Ω	DP t 5	-199.9 to 600.0	-328 to 1,112	
DPt100Ω	DP t 1	-199.9 to 850.0	-328 to 1,530	
Analog	Current	0.00 - 20.00 mA 4.00 - 20.00 mA	-1,999 to 9,999 (Display range is variable according to decimal point position.)	
	Voltage	-50.0 - 50.0 mV		R n u 1
		-199.9 - 200.0 mV		R n u 2
		-1.000 - 1.000 V		R - u 1
		-1.00 - 10.00 V	R - u 2	

* Above input types which have the * mark are displayed only in Input specification expansion. Refer to 'Mode Setting' to check how to enter the mode.

■ Display accuracy

Input type	Using temperature	Display accuracy
Thermocouple	At room temperature (25 °C ± 5 °C)	PV ± 0.2% F.S. ± 1 digit
RTD		• Thermocouple below -100 °C: (PV ± 0.4% F.S.) ± 1 digit
Analog	Out of room temperature range	PV ± 0.3% F.S. ± 1 digit

* In case of TC-T, TC-U, ± 2.0 °C will be added to the degree standard.

Unit Descriptions

- Display part (red)**
Run mode: Displays PV (Present value).
Setting mode: Displays parameter and setting value.
- Unit sticker part**
- Alarm output indicator**
Turns ON when the alarm output is ON.
- [M] key**
Used to enter parameter set mode, move to parameters, save SV and return to RUN mode.
- [◀], [▲], [▼] key**
Used to enter and change parameter setting value.
- Bar graph (green)**
Refer to 'Bar Graph'.
- Space for recognizing device by user**
- Selection switch for input specification**
 - 0 - 20 mA:** Select it for DC 0 (4) - 20 mA input (default)
 - 1 - 10 V:** Select it for -1 - 10 VDC≐ input
 - RTD / TC / mV / ± 1 V:** Select it for Thermocouple, RTD, ± 1 V, mV input

* The setting of input type selection switch and the setting value of input type parameter should be same and it can display the proper measurement value.

Dimensions

- Unit: mm, For the detailed drawings, follow the Autonics website.
- Below is based on KN-1000B series.

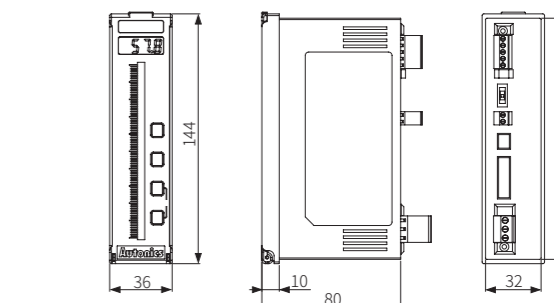

■ Bracket

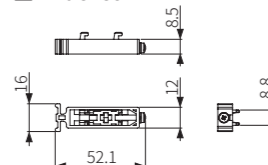

■ Panel cut-out



Connections

■ KN-10□□B

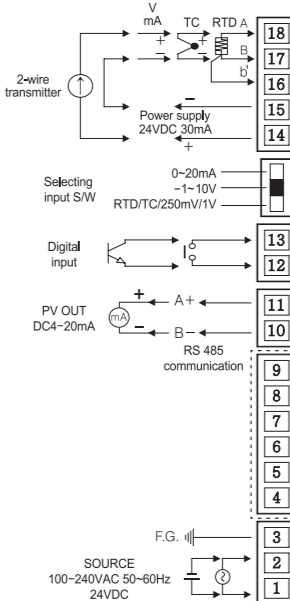

■ KN-12□□B

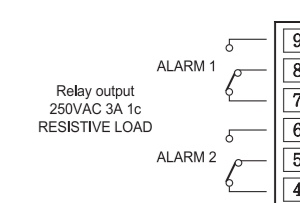

■ KN-14□□B

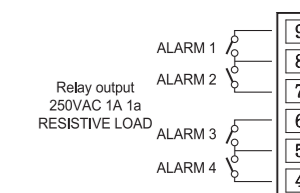

Errors		
Display	Description	Troubleshooting
b U r n	Flashes when input sensor is disconnected or sensor is not connected.	Check input sensor status.
H H H H	Flashes when PV is higher than input range.	When input is within the rated input range, this display disappears.
L L L L	Flashes when PV is lower than input range.	
E r r	Flashes when there is an error of setting value	Check the setting condition and reset.

Mode Setting

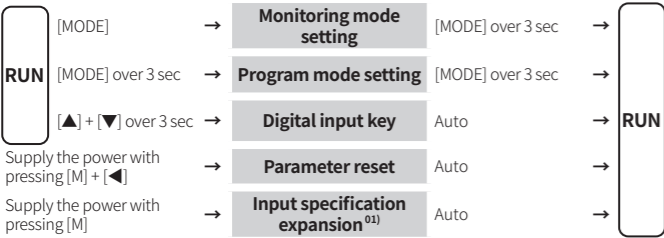

01) Refer to 'Communication Parameter Setting' for checking the details about communication.

Parameter Setting

- Some parameters are activated/deactivated depending on the model or setting of other parameters. Refer to the descriptions of each item.
- [MODE] key: Move to next item after saving
- [◀] key: Select parameter / Move digits
- [▶], [▼] key: Select parameter / Change setting value
- Return to the RUN mode without saving when there is no key input for more than 30 seconds.

Monitoring Mode

Parameter	Display	Default	Setting range	Condition
1-1 AL1 alarm temperature	AL 1	099.9	Sensor input: within using range Analog Input: L-SC ≤ AL1 ≤ H-SC	2-15/17/19/21 AL-1/2/3/4 alarm operation: AT1, AT2
1-2 AL2 alarm temperature	AL 2	099.9	[4 alarm output model] Same as 1-1/2 AL1/2 alarm temperature	AT1, AT2
1-3 AL3 alarm temperature	AL 3	000.1		
1-4 AL4 alarm temperature	AL 4	000.1		
1-5 High peak	HPEP	----	Check only (not available to set) Displays high/low peak (Max./Min. input) value • Initial high/low peak is saved after 2 sec from supplying the power.	
1-6 Low peak	LPEP	----	• Value reset: [▲] + [▼] key over 3 sec in 1-5/6 High/Low peak parameter	

Program mode

Parameter	Display	Default	Setting range	Condition
2-1 Input specification	i n - P	R5R1	Refer to 'Input Type and Using Range'.	-
2-2 Temperature unit	Unit	°C	°C, °F	2-1 Input specification: Thermocouple, RTD
2-3 Low limit input	L - r G	000.0	Using range low limit ≤ L-RG ≤ using range high limit - 10% of F.S.	2-1 Input specification: Analog
2-4 High limit input	H - r G	200.0	L-RG + 10% of F.S. ≤ H-RG ≤ using range high limit	
2-5 Decimal point	d.P	0.0	0.0, 0.00, 0.000, 0	
2-6 Low limit scale	L - 5 C	000.0	-1,999 ≤ L-SC < H-SC ≤ 9,999	
2-7 High limit scale	H - 5 C	100.0	• When setting '2-24 Input special function: TUF' L-SC: -760.0, H-SC: 0 to 9,999	
2-8 Input correction ⁰¹⁾	i n - b	000.0	-999 to 999, L-SC ≤ IN-B < H-SC	2-1 Input specification: Thermocouple, RTD
2-9 Bar graph display low limit scale	L - b 5	000.0	• Input: Thermocouple, RTD Input range low limit ≤ L-BS ≤ (H-BS-1) (L-BS+1) ≤ H-BS ≤ Input range high limit	2-1 Input specification: Analog
2-10 Bar graph display high limit scale	H - b 5	100.0	• Input: Analog L-SC ≤ L-BS ≤ (H-SC-1) (L-SC+1) ≤ H-BS ≤ H-SC	
2-11 Bar graph display method	b R r	F, b R r	F.BAR: Full bar, C.BAR: Center bar	
2-12 4 mA transmission output scale	L o U t	000.0	[Transmission output model] • Input: Thermocouple, RTD: Within input range	
2-13 20 mA transmission output scale	H o U t	100.0	• Input: Analog L-SC ≤ L.OUT ≤ 10% of F.S. ≤ H.OUT ≤ H-SC	
2-14 Input and transmission output extension ⁰²⁾	E x t	5 P	[Transmission output model] Setting value Input range Transmission output range 0P No extension 4 - 20 mA 5P ±5% extension 3.2 - 20.8 mA 10P ±10% extension 2.4 - 21.6 mA	2-1 Input specification: Analog
2-15 AL1 alarm operation	AL - 1	AL t L R	[Alarm output model] □□□ AT0: Off AT1: Absolute high limit alarm AT2: Absolute low limit alarm SBA: Sensor break alarm	
2-16 AL1 alarm option	AL - 1	□□□■	A: Standard alarm B: Alarm latch C: Standby D: Alarm latch and sequence standby sequence • Enter to option setting: Press [◀] key in 2-15 AL-1 alarm operation.	
2-17 AL2 alarm operation	AL - 2	AL t L R	[Alarm output model]	
2-18 AL2 alarm option	AL - 2	AL t L R	Same as 2-15/16 AL1 alarm operation/option	
2-19 AL3 alarm operation	AL - 3	AL t L R	[4 alarm output model]	
2-20 AL3 alarm option	AL - 3	AL t L R	Same as 2-15/16 AL1 alarm operation/option	
2-21 AL4 alarm operation	AL - 4	AL t L R		
2-22 AL4 alarm option	AL - 4	AL t L R		
2-23 Alarm output hysteresis	R - H y	00	001 to 999	2-15/17/19/21 AL-1/2/3/4 alarm operation: AT1, AT2
2-24 Input special function	i n 5 F	L i n	LIN: Linear, ROOT: Root, SQAR: Square, TUF: Two unit function	2-1 Input specification: Analog
2-25 Input digital filter	ñ R u F	0 4	01 (OFF) to 16 • It does not affect the display cycle.	
2-26 Digital input Terminal	d i - t	H o L d	HOLD: Hold, ZERO: Zero-point adjustment, AL.RE*: Alarm reset	* 2-16/18/20/22 AL1/2/3/4 Alarm option: B, D
2-27 Digital input key	d i - k	H o L d	[Alarm output model]	
2-28 Sensor break alarm output	b U r n	o F F	[Transmission output model] OFF: 4 mA, ON: 20 mA	
2-29 Comm. address	R d r r	0 1	[Communication output model] 01 to 99	
2-30 Comm. speed	b R U d	9 6 0 0	[Communication output model] 9600, 4800, 2400, 1200 bps	
2-31 Lock	L o C	o F F	OFF LOC1: Program mode lock (check only) Monitoring mode unlock LOC2: Checking and setting program mode lock Monitoring mode setting lock (check only)	

01) When '2-24 input special function' parameter is set to 'TUF', the function corrects the atmospheric pressure input value.

02) Extension is not allowed below 0 mA and 0 V. ±1 V and 10 V inputs cannot be set to 10P.

Communication Parameter Setting

RUN status group

Address	Parameter	Display	Output range
300001 (0000)	Display value output	-	Display value
			[2 alarm output model]: 0 to 3 [4 alarm output model]: 0 to 15
			Output value Alarm status
			0 OFF OFF OFF OFF
			1 ON OFF OFF OFF
			2 OFF ON OFF OFF
			3 ON ON OFF OFF
			4 OFF OFF ON OFF
			5 ON OFF ON OFF
			6 OFF ON ON OFF
			7 ON ON ON OFF
			8 OFF OFF OFF ON
			9 ON OFF OFF ON
			10 OFF ON OFF ON
			11 ON ON OFF ON
			12 OFF OFF ON ON
			13 ON OFF ON ON
			14 OFF ON ON ON
			15 ON ON ON ON

Monitoring mode setting group

Address	Parameter	Display	Setting range
302001 (07D0) to 302004 (07D3)	AL1 ~ 4 alarm temperature	AL 1 - 4	[Alarm output model] Thermocouple, RTD input: Within input specification, Analog input: L-SC~ H-SC
302005 (07D4)	High peak	HPEP	-
302006 (07D5)	Low peak	LPEP	-

Program mode setting group

Address	Parameter	Display	Setting range	Condition
301001 (03E8)	Input specification	i n - P	Value Display Value Display Value Display Value Display 0 t C P 1 (6) t C - b (12) t C - P 18 R5R1 1 t C P 2 (7) t C - 5 (13) C U 5 0 19 R5R2 2 t C - U (8) t C - n (14) C U 1 0 20 R5U1 3 t C - E (9) t C - C (15) J P t . 1 21 R5U2 4 t C - t (10) t C - L 16 d P t . 5 22 R - u 1 5 t C - r (11) t C - U 17 d P t . 1 23 R - u 2	• The setting values in '(') parenthesis can be set only in 'Input specification expansion' mode. Refer to 'Mode Setting'.
301002 (03E9)	Temperature unit	Unit	0: °C, 1: °F	
301003 (03EA)	Low limit Input	L - r G	Same as parameter setting range	
301004 (03EB)	High limit Input	H - r G	Same as parameter setting range	
301005 (03EC)	Decimal point	d.P	0: 0, 1: 0.0, 2: 0.00, 3: 0.000	
301006 (03ED)	Low limit scale	L - 5 C	Same as parameter setting range	
301007 (03EE)	High limit scale	H - 5 C	Same as parameter setting range	
301008 (03EF)	Bar graph display low limit scale	L - b 5	Same as parameter setting range	
301009 (03F0)	Bar graph display high limit scale	H - b 5	Same as parameter setting range	
301010 (03F1)	Bar graph display method	b R r	0: Full bar, 1: Center bar	
301011 (03F2)	4 mA transmission output scale	L o U t	Same as parameter setting range	
301012 (03F3)	20 mA transmission output scale	H o U t	Same as parameter setting range	
301013 (03F4)	Input and transmission output extension	E x t	0: 0%, 1: 5%, 2: 10%	Same as each parameter setting condition
301014 (03F5) to 301017 (03F8)	AL1 to 4 alarm operation	AL - 1 - 4	1: Absolute high limit alarm, 2: Absolute low limit alarm, 3: Sensor break alarm, 4: Off	
301018 (03F9) to 301021 (03FC)	AL1 to 4 alarm option	AL - 1 - 4	10: Standard alarm, 11: Alarm latch, 12: Standby sequence, 13: Alarm latch and standby sequence, 14: No alarm (not settable)	
301022 (03FD)	Alarm output hysteresis	R - H y	Same as parameter setting range	
301023 (03FE)	Input special function	i n 5 F	0: Linear, 1: Root, 2: Square, 3: Two unit function	
301024 (03FF)	Input correction	i n - b	Same as parameter setting range	
301025 (0400)	Input digital filter	ñ R u F	Same as parameter setting range	
301026 (0401)	Digital input Terminal	d i - t	0: Alarm reset, 1: Hold, 2: Zero-point adjustment	
301027 (0402)	Digital input key	d i - k		
301028 (0403)	Sensor break alarm output	b U r n	0: 20 mA, 1: 4 mA	
301029 (0404)	Comm. address	R d r r	Same as parameter setting range	
301030 (0405)	Comm. speed	b R U d	0: 9600, 1: 4800, 2: 2400, 3: 1200	
301031 (0406)	Lock	L o C	0: OFF, 1: LOC1, 2: LOC2	

Function: Bar Graph

Display method setting

It is possible to set in bar graph display method parameter.

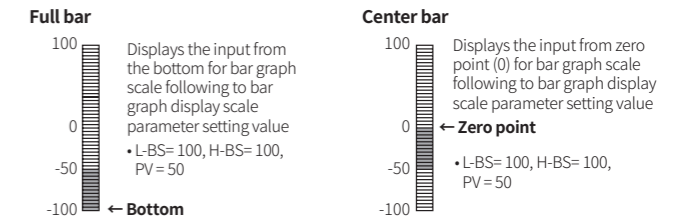

Alarm display in bar graph

When setting or occurring the alarm, it displays the status by the bar graph. It is possible to check the alarm status. When setting alarm value, the bar LED for this alarm value turns ON. When alarm occurs, the bar LED for this alarm value flashes.

- If alarm set value is out of bar graph scale when setting the value or in RUN mode, this value does not display in bar graph.

Monitoring mode: setting alarm value Run mode: alarm display

The bar LED for alarm setting value flashes. When alarm set is complete, the bar LED for this alarm value turns ON. All set alarm values are displays and when it is alarm value, the bar LED for this alarm value flashes.

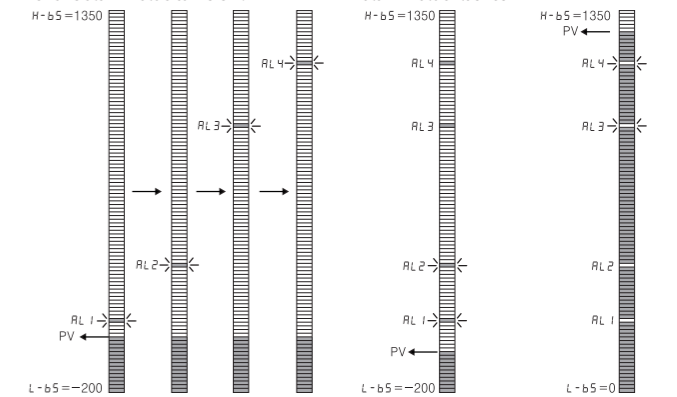

- The bar LED for the alarm value flashes.
- AL1/2: Low limit alarm
- AL3/4: High limit alarm

Scale value relation

Below is relation example of input specification, high/low limit input, high/low limit scale, bar graph display high/low limit scale, 4/20 mA transmission output scale when using 4 to 20 mA input specification.

Refer to 'Parameter Setting' for the details about setting range and condition.

