

T4WM Series

Automatic switching function of 5 point temperature indication

■ Features

- Indication type only
- High accuracy measurement: F.S. $\pm 0.5\%$
- 5 Point temperature measurement
- Automatic or manual display of temperature in each point

 Please read "Caution for your safety" in operation manual before using.



■ Ordering information

T	4	W	M	-	N	3	N	P	4	C
Item	Digit	Size	Input	Control method	Power supply	Control output	Sensor input type	Temperature range	Unit	
									C	°C
								0		-99.9 to 199.9
								4		0 to 399
								5		0 to 500
								C		0 to 1200
							P			DPt100Ω
							J			J(IC)
							K			K(CA)
							N			No output
							3			110/220VAC 50/60Hz
							N			No control
							M			5 Point Indicator
							W			DIN W96×H48mm
							4			9999(4digit)
							T			Temperature Controller

※ Please check the range of temperature when select model.

■ Temperature range for each sensor

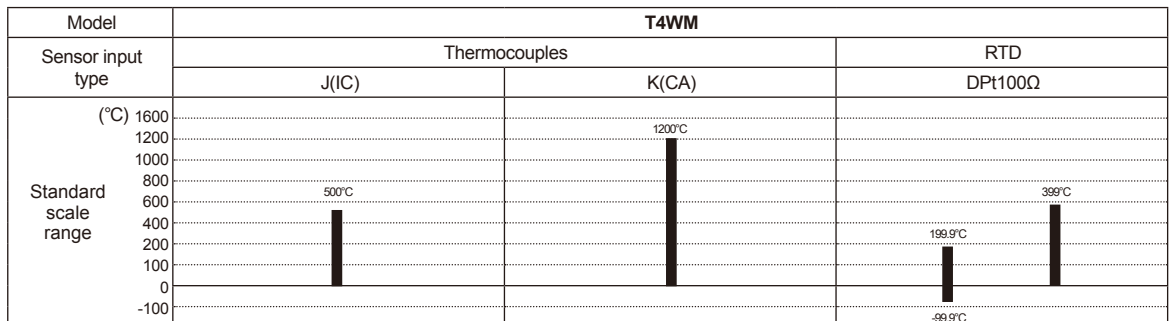

5 Point Input type

Specifications

Series	T4WM	
Power supply	110/220VAC 50/60Hz	
Allowable voltage range	90 to 110% of rated voltage	
Power consumption	Max. 3VA	
Display method	7 Segment(red) LED method	
Character size(W×H)	9.8×14.2mm	
Display accuracy	F.S. ±0.5% rdg ±1digit	
Input sensor	Thermocouples : K(CA), J(IC) / RTD: DPT100Ω	
Input line resistance	Thermocouples: Max. 100Ω / RTD: Allowable line resistance max. 5Ω per a wire	
Connectable sensors	5EA(thermocouple, RTD are not used as mixed)	
Channel switch	Selectable Auto/Manual switching	
Auto switching time	Variable 1 to 10 sec.(by built-in VR)	
Insulation resistance	Min. 100MΩ(at 500VDC megger)	
Dielectric strength	2,000VAC 50/60Hz for 1 min.	
Noise strength	±1kV the square wave noise(pulse width: 1μs) by the noise simulator	
Vibration	Mechanical	0.75mm amplitude at frequency of 10 to 55Hz(for 1 min.) in each of X, Y, Z directions for 1 hour
	Malfunction	0.5mm amplitude at frequency of 10 to 55Hz(for 1 min.) in each of X, Y, Z directions for 10 min.
Shock	Mechanical	300m/s ² (approx. 30G) in each of X, Y, Z directions for 3 times
	Malfunction	100m/s ² (approx. 10G) in each of X, Y, Z directions for 3 times
Environment	Ambient temperature	-10 to 50°C, storage:-25 to 65°C
	Ambient humidity	35 to 85%RH, storage: 35 to 85%RH
Unit weight	Approx. 322g	

※Environment resistance is rated at no freezing or condensation.

Parts description

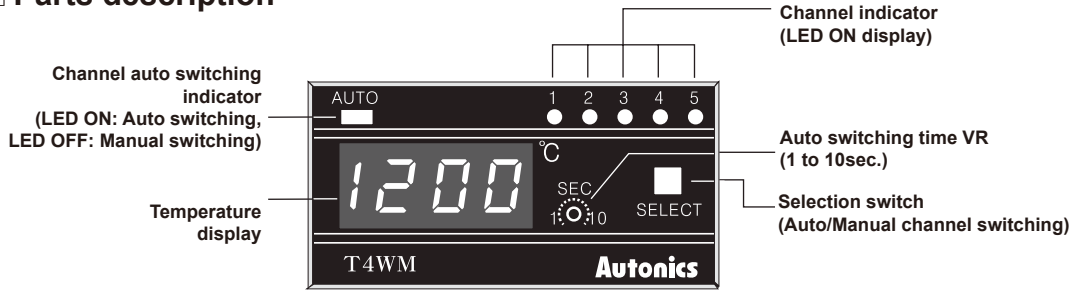

Connections

※RTD: DPT100Ω(3-wire type) ※Thermocouple: K, J

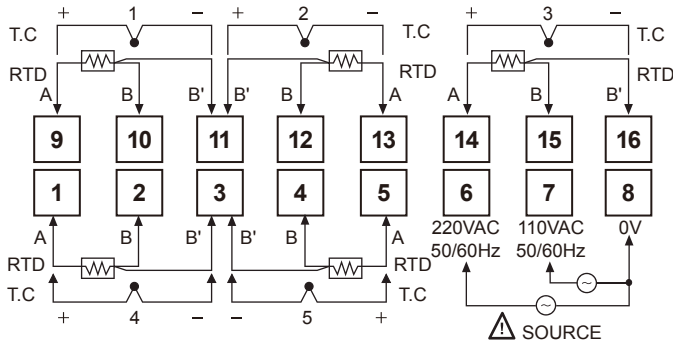

(A)	Photo electric sensor
(B)	Fiber optic sensor
(C)	Door/Area sensor
(D)	Proximity sensor
(E)	Pressure sensor
(F)	Rotary encoder
(G)	Connector/Socket
(H)	Temp. controller
(I)	SSR/ Power controller
(J)	Counter
(K)	Timer
(L)	Panel meter
(M)	Tacho/ Speed/ Pulse meter
(N)	Display unit
(O)	Sensor controller
(P)	Switching mode power supply
(Q)	Stepper motor& Driver&Controller
(R)	Graphic/ Logic panel
(S)	Field network device
(T)	Software
(U)	Other

T4WM Series

■ Dimensions

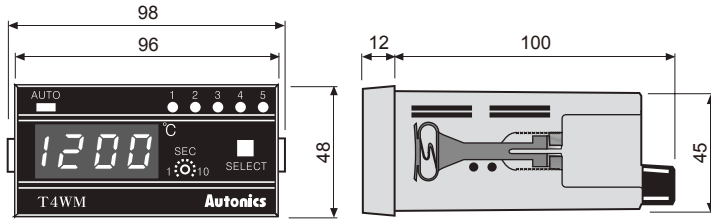

● Panel cut-out

(unit: mm)

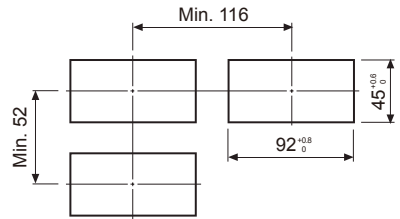

■ Channel switching

◎ Auto/Manual channel switching

Auto switching	Select switch	Manual switching
When pressing this for 3sec. and the channel auto switching indicator turns ON and channels switch automatically. (AUTO LED: ON)		When press this once, the channel indicator turns ON and channels switch manually (AUTO LED: OFF)

◎ Auto channel switching

- The temperature of each channel is displayed during auto switching time and switching to the next channel automatically.
- Auto switching time is variable up to 10 sec. by the front VR.
- When it is auto channel switching, the channel auto switching indicator turns ON.

◎ Manual channel switching

Whenever touching selection switch(SELECT), channel switches.

When a channel indicator turns ON, the temperature of the channel is displayed and whenever touching the switch, it moves to next channel.

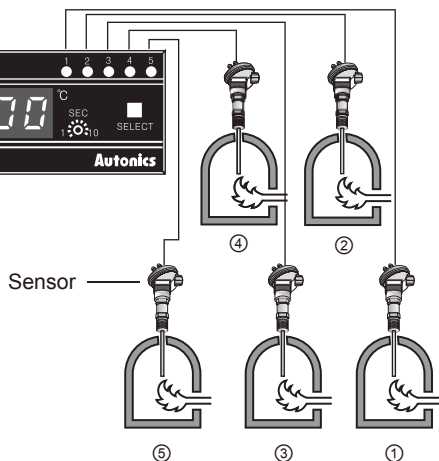

■ Selection of input sensor number by internal DIP switch

Max. 5 different sensors can be connected but do not use thermocouple and Pt100Ω together.

Sensor	2	3	4	5
DIP switch	ON 3 2 1 OFF ■ ■ ■	ON 3 2 1 OFF ■ ■ ■	ON 3 2 1 OFF ■ ■ ■	ON 3 2 1 OFF ■ ■ ■

■ Memory protection

When the power fails, the data value will be protected for 3 months.(The battery must be charged fully.)