

Analog Timer

T38N / T48N / T57N / TF62N / TF62D**INSTRUCTION MANUAL**

Thank you for purchasing HANYOUNG NUX Co.,Ltd. product.

Please check whether the product you purchased is the exactly same as you ordered.

Before using this product, please read instruction manual carefully.

**HEAD OFFICE**1381-3, Juan-Dong, Nam-Gu Incheon, Korea
TEL: (82-32)876-4697 FAX: (82-32)876-4696**■ Safety Information**

Please read safety information carefully before use and then use this product properly. Safety information described in this manual contains important contents related with safety. So please follow the instructions accordingly. Safety information is composed of DANGER, WARNING and CAUTION.

**DANGER**

Do not touch or contact the input/output terminals because they may cause electric shock.

**CAUTION**

- The contents of this manual may be changed without prior notice.
- Please check whether the product you purchased is the exactly same as you ordered.
- Please check whether the product has no damage or abnormality during delivery.
- Do not use this product with time setting "0"
- Change setting time in condition of "Power OFF". If change setting time in condition of "Power On", reset should be done.
- Do not use the product at the places which have corrosive(especially noxious gas or ammonia) or flammable gas.
- Do not use this product at any place with direct vibration or impact.
- Do not use this product at any place with liquid, oil, medical substances, dust, salt or iron contents. (Pollution level 1 or 2)
- Do not polish this product by substances such as alcohol or benzene.
- Do not use this product at any place with excessive induction trouble, static electricity or magnetic noise.
- Do not use this product at any place with possible thermal accumulation due to direct sunlight or heat radiation.
- Install this product at place under 2,000m in altitude.
- When the product gets wet, the inspection is essential because there is danger of an electric leakage or fire.
- If there is an excessive noise from power supply, it is recommended to use insulating transformer and noise filter. The noise filter must be attached to the panel grounded and wiring between the filter output side and power supply terminal should be as short as possible.
- If gauge cables are arranged too closely, the effect on noise may occur.
- Do not connect anything to the unused terminals.
- After checking polarity of terminal, connect wires to the right position.
- When this product is connected to a panel, use a circuit breaker or switch approved by IEC847-1 or IEC947-3.
- Install the circuit breaker or switch at near place for convenient use.
- Write down on a label that the operation of circuit breaker or switch disconnects the power since the devise is installed.
- For the continuous and safe use of this product, the periodic maintenance is recommended.
- Some parts of this product have limited life span, and others are changed by their usage.
- The warranty period of this product including parts is one year if this product is properly used.
- When power is on, the preparation period of contact output is required. In case of using signals of external interlock circuit, use a delay Relay.

**WARNING**

- If there is a possibility of an accident caused by errors or malfunctions of this product, install external protection circuit to prevent the accident.
- This product does not contain an electric switch or fuse, so the user needs to install a separate electric switch or fuse externally. (Fuse rating : 250 V 0.5 A)
- To prevent deflection or malfunction of this product, supply proper power voltage in accordance with the rating.
- To prevent electric shock or malfunction of this product, do not supply the power until the wiring is completed.
- Since this product is not designed to explosion-protective structure, do not use it at the places which have flammable or explosive gas.
- Do not disassemble, modify, revise or repair this product. This may cause malfunction, electric shock or fire.
- Attach or detach this product while the power is off. Otherwise, it may cause malfunction or electric shock.
- If you use the product with methods other than specified by the manufacturer, there may be bodily injuries or property damages.
- Due to the danger of electric shock, use this product installed onto a panel while an electric current is applied.

■ Ordering Information

Model	Code	Description
	<input type="checkbox"/> - <input type="checkbox"/> <input type="checkbox"/> <input type="checkbox"/> <input type="checkbox"/>	Analog Timer
Model	T38N	48.0(W) × 59.0(H)mm ※It's necessary to use Panel Mount Adaptor in Case of Panel Type
	T48N	48.0(W) × 48.0(H)mm
	T57N	
	TF62N	E' Size - 50.0(W) × 62.0(H)mm P' Size - 57.5(W) × 84.5(H)mm
	TF62D	
Fixture type	E	Exposure type
	P	Panel type
Time Range	01	1 sec / 1 min / 1 hour
	03	3 sec / 3 min / 3 hour
	06	6 sec / 6 min / 6 hour
	10	10 sec / 10 min / 10 hour
	30	30 sec / 30 min / 30 hour
	60	60 sec / 60 min / 60 hour
	12H	12 hour / 24 hour / 48 hour (exception : TF62N & TF62D)
Control output	A	Time - limit 1c + Constant 1a (For T38N / T48N / T57N)
	B	Time - limit 1c + Constant 1c (For T38N / T48N / T57N)
	C	Time - limit 2c (For T38N / T48N / T57N)
	D	Time - limit 1c (For TF62N)
	F	Time - limit 2c (For TF62D)

■ Specification

MODEL	Exposure type(E)	T38N	T48N	T57N-E	TF62N-E	TF62D-E
	Panel type(P)			T57N-P	TF62N-P	TF62D-P
Function		POWER ON DELAY TIMER			TWIN TIMER	DUAL TIMER
Power supply		24 - 240 V a.c 50 - 60Hz, 24 - 240 V d.c				
Allowable Voltage Fluctuation		±10 % of Power supply voltage				
Power Consumption		Less than 4.5 VA (at 240 V a.c 60 Hz), Less than 1.5 W (at 24 V d.c)				
Return time		Less than 100 ms				
Time Range	01	0.01 ~ 1 s / 0.01 ~ 1 m / 0.01 ~ 1 h				
	03	0.01 ~ 3 s / 0.01 ~ 3 m / 0.01 ~ 3 h				
	06	0.01 ~ 6 s / 0.01 ~ 6 m / 0.01 ~ 6 h				
	10	0.01 ~ 10 s / 0.01 ~ 10 m / 0.01 ~ 10 h				
	30	0.01 ~ 30 s / 0.01 ~ 30 m / 0.01 ~ 30 h				
	60	0.01 ~ 60 s / 0.01 ~ 60 m / 0.01 ~ 60 h				
	12H	0.01 ~ 12 h / 0.01 ~ 24 h / 0.01 ~ 48 h ('24h': '12h' x '2', '48': '12h' x '4')				'12' model is not available
Time Error	Repeat error	Less than ± 0.3 % (ratio against Max. scale)				
	Setup error	Less than ± 5 % (ratio against Max. scale)				
Control output	Output mode	Power Time - limit			FLICKER (ON Start)	FLICKER (ON-A Start)
	Contact construction	A type (Time - limit 1c + Instantaneous 1a) / B type (Time - limit 1c + Instantaneous 1c) / C type (Time - limit 2c)			D type (Time - limit 1c)	F type (Time - limit 2c)
	Capacity	250 V a.c 3 A Resistive load				
Life span of relay		Mechanical : More than 10 million times / Electrical : More than 100,000 times				
Dielectric strength		2000 V a.c 50/60 Hz for 1 minute				
Noise		±2 kV				
Insulation resistance		More than 100 MΩ (Based on 500 V d.c mega standard)				
Vibration (Durability)		10 - 55 Hz (cycle : 1 minute), Double amplitude 0.5 mm X · Y · Z each direction for 2h.				
Shock (Durability)		300 1/6 (30 G) X · Y · Z each direction 3 times				
Ambient temperature		-10 ~ 55 °C Without freeze				
Storage temperature		-25 ~ 65 °C Without freeze				
Ambient humidity		30 ~ 85 % R.H.				
Certification		 certified (Exception : TF62D)				

■ Front View

■ T38N

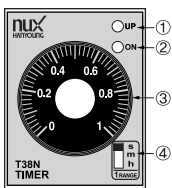

■ T48N

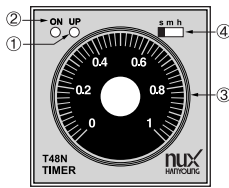

■ T57N

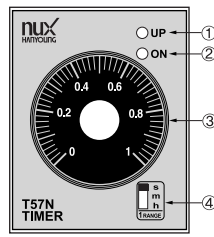

■ TF62N

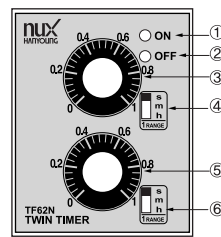

■ TF62D

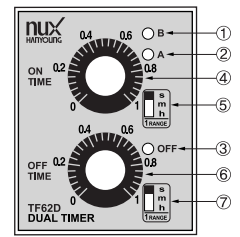

Function		Contents
T38N T48N T57N	① Output Indication LED(UP LED)	After passing setup time. LED is ON at the same time when operating time-limit output.
	② Power Supply Indication LED(ON LED)	LED is OFF when timer works. LED is ON at the same time when operating time-limit output and its status will be maintained.
	③ Time Display	It's possible to change time setup together with knob and you can change setup time in the middle of it's function.
	④ Time unit setup switch (s/m/h)	It is consisted of Hour(h), Minute(m), Second(s). You can set and use time unit what you need.(Available to change it when Power is OFF)
TF62N	① Flicker-ON output indication LED	In case of Flicker-ON, LED is ON at the same time when operating time-limit output.
	② Flicker-OFF output indication LED	in case of Flicker-ON, LED is ON at the same time when stopping time-limit output.
	③ Flicker-ON time display	It is used to set operating time of time-limit output in the Flicker-ON mode. Setup time could be changed during operation of timer.
	④ Flicker-ON time unit setup switch	It is consisted of Hour(h), Minute(m), Second(s). You can set and use ON time unit what you need.(Available to change it when Power is OFF)
TF62D	⑤ Flicker-OFF time display	It is used to set stopping time of time-limit output in the Flicker-ON mode. Setup time could be changed during operation of timer.
	⑥ Flicker-OFF time unit setup switch	It is consisted of Hour(h), Minute(m), Second(s). User can set his own Flicker-OFF time unit (Available to change it when Power is OFF)
	① LED for indicating output of Dual-B ON	In case of Dual function, LED is ON at the same time when operating B output.
	② LED for indicating output of Dual-A ON	In case of Dual function, LED is ON at the same time when operating A output.
	③ LED for indication output of Dual A/B OFF	In case of Dual function, LED is OFF at the same time when stopping A output or B output.
	④ Setup time dispaly of Dual A/B ON	It is used together with knob to set ON operation time setup of A output and B output. Setup time could be changed during operation of timer.
	⑤ Time unit setup switch of Dual A/B ON	It is consisted of Hour(h), Minute(m), Second(s). It is used to set ON time unit of A output and B output. (Available to change it when Power is OFF)
⑥ Setup time dispaly of Dual A/B OFF	It is used to set OFF operation time setup of A output and B output. Setup time could be changed during operation of timer.	
⑦ Time unit setup switch of Dual A/B OFF	It is consisted of Hour(h), Minute(m), Second(s). It is used to set OFF time unit of A output and B output. (Available to change it when Power is OFF)	

External Dimension & Panel Cutout

T38N (Unit : mm)

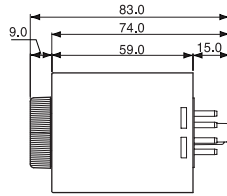
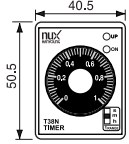

T38N - In case of Using Panel Mount Adaptor (Unit : mm)

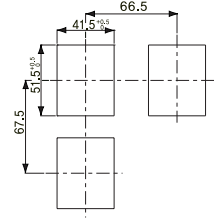
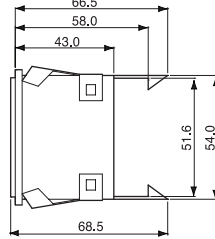
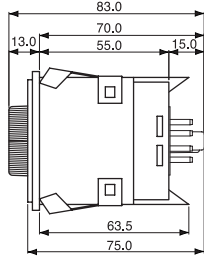
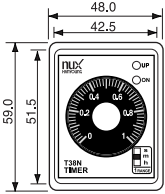

T48N (Unit : mm)

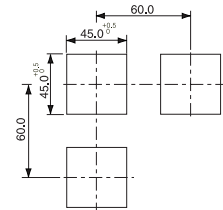
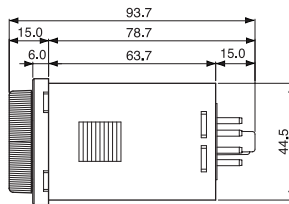
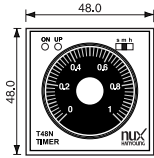

T57NE (Exposure Type) (Unit : mm)

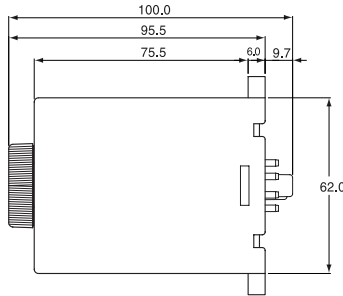
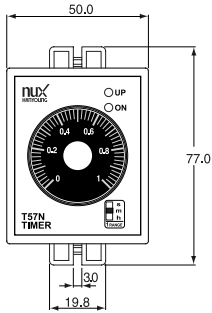

T57NP (Panel Type) (Unit : mm)

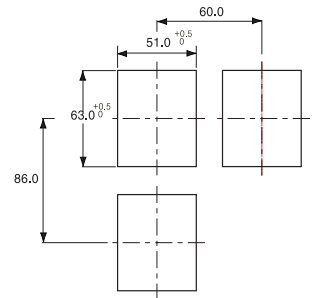
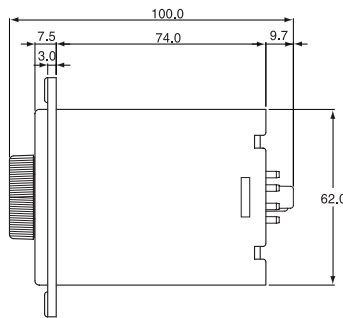
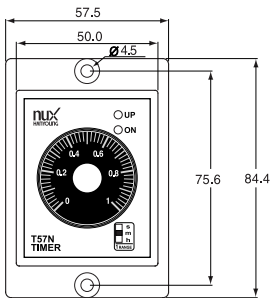

T62NE / TF62DE (Exposure Type) (Unit : mm)

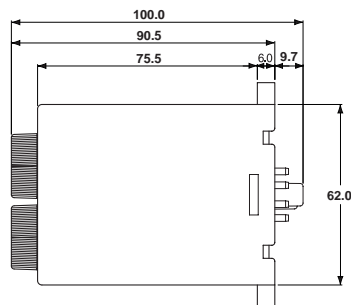
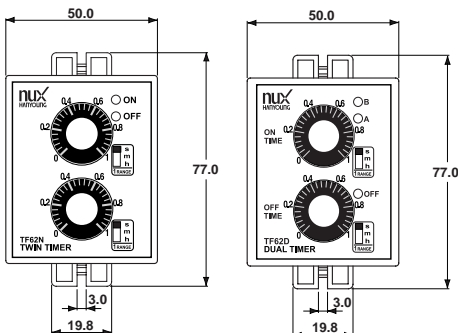

■ T62NP / TF62DP (Panel Type) (Unit : mm)

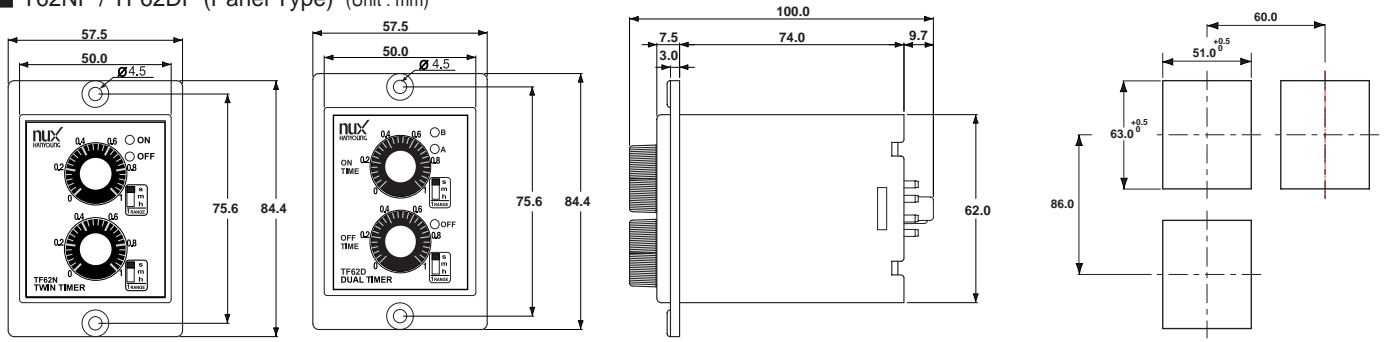

■ Connection Diagram

■ A type (Time - limit 1c + Instantaneous 1a)

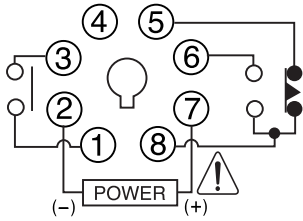

■ B type (Time - limit 1c + Instantaneous 1c)

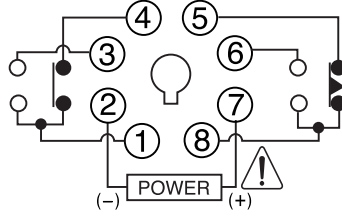

■ C type (Time - limit 2c)

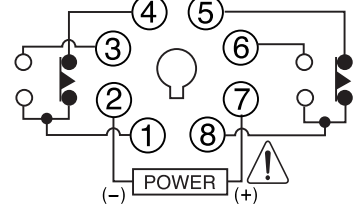

■ D type (Time - limit 1c)

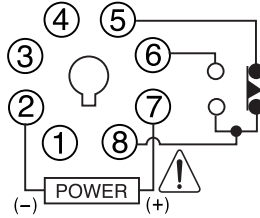

■ F type (Time - limit 2c)

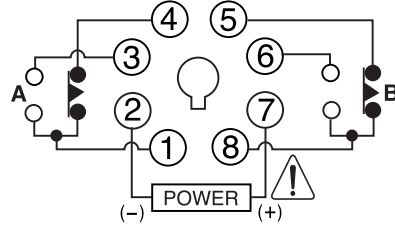

■ Timing Charts

■ A type (Time - limit 1c + Instantaneous 1a)

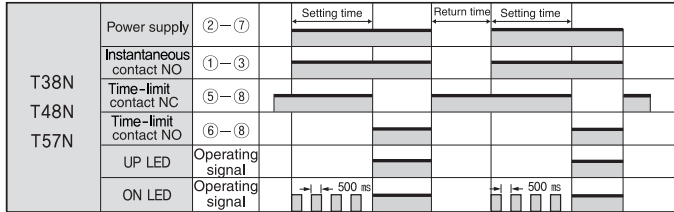

■ B type (Time - limit 1c + Instantaneous 1c)

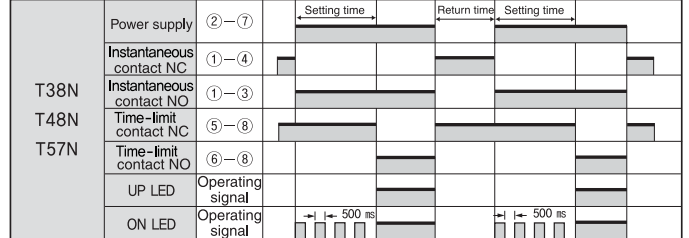

■ C type (Time - limit 2c)

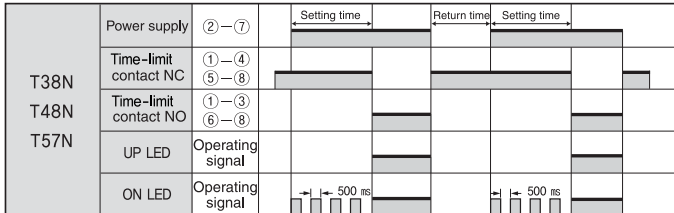

■ D type (Time - limit 1c) - Individual setting of ON / OFF time

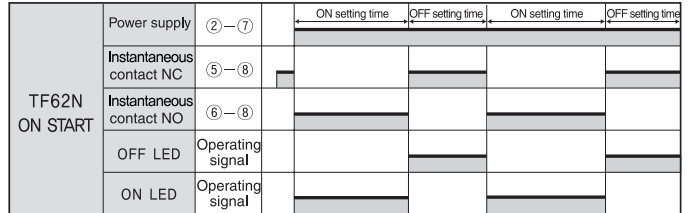

■ F type (Time - limit 2c) - Same ON setup time will be applied to the output A and B

