

## Dual Display PID Temperature Controllers

# TCN Series

## INSTRUCTION MANUAL

TCD210225AA	<b>Autonics</b>
-------------	-----------------

Thank you for choosing our Autonics product.

**Read and understand the instruction manual and manual thoroughly before using the product.**

**For your safety, read and follow the below safety considerations before using.**

**For your safety, read and follow the considerations written in the instruction manual, other manuals and Autonics website.**

Keep this instruction manual in a place where you can find easily.

The specifications, dimensions, etc are subject to change without notice for product improvement
Some models may be discontinued without notice.

Follow Autonics website for the latest information.

Safety Considerations
<ul style="list-style-type: none"><li>Observe all ‘Safety Considerations’ for safe and proper operation to avoid hazards.</li> <li>⚠ symbol indicates caution due to special circumstances in which hazards may occur.</li></ul>
<p><b>⚠ Warning</b> Failure to follow instructions may result in serious injury or death</p>

**01. Fail-safe device must be installed when using the unit with machinery that may cause serious injury or substantial economic loss.(e.g. nuclear power control, medical equipment, ships, vehicles, railways, aircraft, combustion apparatus, safety equipment, crime/disaster prevention devices, etc.)**

Failure to follow this instruction may result in personal injury, economic loss or fire.

**02. Do not use the unit in the place where flammable/explosive/corrosive gas, high humidity, direct sunlight, radiant heat, vibration, impact or salinity may be present.**

Failure to follow this instruction may result in explosion or fire.

**03. Install on a device panel to use.**

Failure to follow this instruction may result in fire or electric shock.

**04. Do not connect, repair, or inspect the unit while connected to a power source.**

Failure to follow this instruction may result in fire or electric shock.

**05. Check ‘Connections’ before wiring.**

Failure to follow this instruction may result in fire.

**06. Do not disassemble or modify the unit.**

Failure to follow this instruction may result in fire or electric shock.

<p><b>⚠ Caution</b> Failure to follow instructions may result in injury or product damage</p>
---

**01. When connecting the power input and relay output, use AWG 20 (0.50 mm<sup>2</sup>) cable or over, and tighten the terminal screw with a tightening torque of 0.74 to 0.90 N m.**

**When connecting the sensor input and communication cable without dedicated cable, use AWG 28 to 16 cable and tighten the terminal screw with a tightening torque of 0.74 to 0.90 N m.**

Failure to follow this instruction may result in fire or malfunction due to contact failure.

**02. Use the unit within the rated specifications.**

Failure to follow this instruction may result in fire or product damage

**03. Use a dry cloth to clean the unit, and do not use water or organic solvent.**

Failure to follow this instruction may result in fire or electric shock.

**04. Keep the product away from metal chip, dust, and wire residue which flow into the unit.**

Failure to follow this instruction may result in fire or product damage.

Cautions during Use
---------------------

- Follow instructions in ‘Cautions during Use’. Otherwise, it may cause unexpected accidents.
- Check the polarity of the terminals before wiring the temperature sensor.
- For RTD temperature sensor, wire it as 3-wire type, using cables in same thickness and length. For thermocouple (TC) temperature sensor, use the designated compensation wire for extending wire.
- Keep away from high voltage lines or power lines to prevent inductive noise. In case installing power line and input signal line closely, use line filter or varistor at power line and shielded wire at input signal line. Do not use near the equipment which generates strong magnetic force or high frequency noise.
- Install a power switch or circuit breaker in the easily accessible place for supplying or disconnecting the power.
- Do not use the unit for other purpose (e.g. voltmeter, ammeter), but temperature controller.
- When changing the input sensor, turn off the power first before changing. After changing the input sensor, modify the value of the corresponding parameter.
- 24 VAC~, 24-48 VDC≐ power supply should be insulated and limited voltage/current or Class 2, SELV power supply device.
- Make a required space around the unit for radiation of heat. For accurate temperature measurement, warm up the unit over 20 min after turning on the power.
- Make sure that power supply voltage reaches to the rated voltage within 2 sec after supplying power.
- Do not wire to terminals which are not used.
- This unit may be used in the following environments.
  - Indoors (in the environment condition rated in ‘Specifications’)
    - Altitude Max. 2,000 m
    - Pollution degree 2
    - Installation category II



Ordering Information											
<p>This is only for reference, the actual product does not support all combinations. For selecting the specified model, follow the Autonics website .</p>											
<table border="1"> <tbody><tr> <td style="text-align: center;"><b>T</b></td> <td style="text-align: center;"><b>C</b></td> <td style="text-align: center;"><b>N</b></td> <td style="text-align: center;"><b>4</b></td> <td style="text-align: center;"><b>①</b></td> <td style="text-align: center;"><b>-</b></td> <td style="text-align: center;"><b>2</b></td> <td style="text-align: center;"><b>②</b></td> <td style="text-align: center;"><b>R</b></td> <td style="text-align: center;"><b>-</b></td> <td style="text-align: center;"><b>③</b></td> </tr> </tbody></table>	<b>T</b>	<b>C</b>	<b>N</b>	<b>4</b>	<b>①</b>	<b>-</b>	<b>2</b>	<b>②</b>	<b>R</b>	<b>-</b>	<b>③</b>
<b>T</b>	<b>C</b>	<b>N</b>	<b>4</b>	<b>①</b>	<b>-</b>	<b>2</b>	<b>②</b>	<b>R</b>	<b>-</b>	<b>③</b>	

<b>① Size</b>	<b>③ Wiring type</b>
S: DIN W 48 × H 48 mm M: DIN W 72 × H 72 mm H: DIN W 48 × H 96 mm L: DIN W 96 × H 96 mm	No mark: Bolt P: Connector plug connection

<b>② Power supply</b>
2: 24 VAC~ 50/60 Hz, 24-48 VDC≐ 4: 100-240 VAC~ 50/60 Hz

Product Components
<ul style="list-style-type: none"><li>Product</li> <li>Bracket</li> <li>Instruction manual</li></ul>

Sold Separately
<ul style="list-style-type: none"><li>Terminal protection cover: RSA / RMA / RHA / RLA Cover</li></ul>

Specifications		
<b>Series</b>	TCN4□-22□-□	TCN4□-24□-□
<b>Power supply</b>	24 VAC~ 50/60 Hz ±10% 24- 48 VDC≐ ±10%	100 - 240 VAC~ 50/60 Hz ±10%
<b>Power consumption</b>	AC: ≤ 5 VA, DC: ≤ 3 W	≤ 5 VA
<b>Sampling period</b>	100 ms	
<b>Input specification</b>	Refer to 'Input Type and Using Range.	
<b>Control output</b>	Relay	250 VAC~ 3A, 30 VDC≐ 3A, 1a
	SSR	12 VDC≐ ±2 V, ≤ 20 mA
<b>Alarm output</b>	250 VAC~ 1 A 1a	
<b>Display type</b>	7 Segment (red, green), LED type	
<b>Control type</b>	Heating, Cooling	ON/OFF, P, PI, PD, PID Control
<b>Hysteresis</b>	1 to 100 (0.1 to 50.0) °C/°F	
<b>Proportional band (P)</b>	0.1 to 999.9 °C/°F	
<b>Integral time (I)</b>	0 to 9,999 sec	
<b>Derivative time (D)</b>	0 to 9,999 sec	
<b>Control cycle (T)</b>	0.5 to 120.0 sec	
<b>Manual reset</b>	0.0 to 100.0%	
<b>Relay life cycle</b>	Mechanical	≥ 5,000,000 operations
	Electrical	OUT1/2: ≥ 200,000 operations (load resistance: 250 VAC~ 3 A) AL1/2: ≥ 300,000 operations (load resistance: 250 VAC~ 1 A )
<b>Dielectric strength</b>	Between input terminal and power terminal: 1,000 VAC~ 50/60 Hz for 1 min	Between input terminal and power terminal: 2,000 VAC~ 50/60 Hz for 1 min
<b>Vibration</b>	0.75 mm amplitude at frequency of 5 to 55 Hz (for 1 min) in each X, Y, Z direction for 2 hours	
<b>Insulation resistance</b>	≥ 100 MΩ (500 VDC≐ megger)	
<b>Noise immunity</b>	±2 kV square shaped noise (pulse width: 1 μs) by noise simulator R-phase, S-phase	
<b>Memory retention</b>	≈ 10 years (non-volatile semiconductor memory type)	
<b>Ambient temperature</b>	-10 to 50 °C, storage: -20 to 60 °C (no freezing or condensation)	
<b>Ambient humidity</b>	35 to 85%RH, storage: 35 to 85%RH (no freezing or condensation)	
<b>Insulation type</b>	Mark: □, double or reinforced insulation (dielectric strength between the measuring input part and the power part: 1 kV)	Mark: □, double or reinforced insulation (dielectric strength between the measuring input part and the power part: 2 kV)
<b>Approval</b>	CE  ENEC 	
<b>Unit weight (packaged)</b>	• TCN4S: ≈ 100 g (≈ 147 g)	• TCN4M: ≈ 133 g (≈ 203 g)
	• TCN4H: ≈ 124 g (≈ 194 g)	• TCN4L: ≈ 179 g (≈ 275 g)

Input Type and Using Range					
The setting range of some parameters is limited when using the decimal point display.					
Input type	Decimal point	Display	Using range (°C)	Using range (°F)	
Thermo-couple	K (CA)	1	ℰℰRH	-50 to 1,200	-58 to 2,192
		0.1	ℰℰRL	-50.0 to 999.9	-58.0 to 999.9
	J (IC)	1	JℱℰH	-30 to 800	-22 to 1,472
		0.1	JℱℰL	-30.0 to 800.0	-22.0 to 999.9
	L (IC)	1	LℱℰH	-40 to 800	-40 to 1,472
		0.1	LℱℰL	-40.0 to 800.0	-40.0 to 999.9
T (CC)	1	ℰℰℰH	-50 to 400	-58 to 752	
	0.1	ℰℰℰL	-50.0 to 400.0	-58.0 to 752.0	
R (PR)	1	rPr	0 to 1,700	32 to 3,092	
	S (PR)	1	SPr	0 to 1,700	32 to 3,092
RTD	Cu50 Ω	1	ℰℰ5H	-50 to 200	-58 to 392
		0.1	ℰℰ5L	-50.0 to 200.0	-58.0 to 392.0
	DPT100 Ω	1	dPEH	-100 to 400	-148 to 752
		0.1	dPEL	-100.0 to 400.0	-148.0 to 752.0

### ■ Display accuracy

Input type	Using temperature	Display accuracy
Thermocouple RTD	At room temperature (23°C ±5 °C)	(PV ±0.5% or ±1 °C higher one) ±1-digit <ul style="list-style-type: none"><li>Thermocouple R, S below 200 °C: (PV ±0.5% or ±3 °C higher one) ±1-digit</li> <li>Over 200 °C: (PV ±0.5% or ±2 °C higher one) ±1digit</li> <li>Thermocouple L, RTD Cu50 Ω: (PV ±0.5% or ±2 °C higher one) ±1-digit</li></ul>
	Out of room temperature range	(PV ±0.5% or ±2 °C higher one) ±1-digit <ul style="list-style-type: none"><li>Thermocouple R, S below 200 °C: (PV ±1.0% or ±6 °C higher one) ±1digit</li> <li>Over 200 °C: (PV ±0.5% or ±5 °C higher one) ±1digit</li> <li>Thermocouple L, RTD Cu50 Ω: (PV ±0.5% or ±3 °C higher one) ±1digit</li></ul>

- For TCN4S-□-P, add ±1°C by accuracy standard.
- If the input specification is set to 'decimal point 0.1' display, add ±1°C by accuracy standard.

Unit Descriptions
-------------------

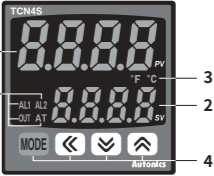
	<p><b>1. PV Display part (red)</b></p> <ul style="list-style-type: none"><li>RUN mode: Displays PV (Present value)</li> <li>Setting mode: Displays parameter name</li></ul>
	<p><b>2. SV Display part (green)</b></p> <ul style="list-style-type: none"><li>RUN mode: Displays SV (Setting value)</li> <li>Setting mode: Displays parameter setting value</li></ul>

3. Indicator	Display	Name	Description	4. Input key	Display	Name
	AL1/2	Alarm output	Turns ON when the alarm output is ON.		[MODE]	Mode key
	OUT	Control output	Turns ON when control output is ON <ul style="list-style-type: none"><li>CYCLE/PHASE control of SSR drive output: Turns ON when MV is over 3.0% [AC power model]</li></ul>		[◀], [▼], [▲]	Setting value control key
	AT	Auto tuning	Flashes during auto tuning every 1 sec			
	°C, %, °F	Unit	Displays selected unit (parameter).			

Errors		
Display	Description	Troubleshooting
oPE n	Flashes when input sensor is disconnected or sensor is not connected.	Check input sensor status.
HHHH	Flashes when PV is higher than input range.	When input is within the rated input range, this display disappears.
LLLL	Flashes when PV is lower than input range.	

## Dimensions

- Unit: mm, For the detailed drawings, follow the Autonics website.
- Below is based on TCN4S Series.

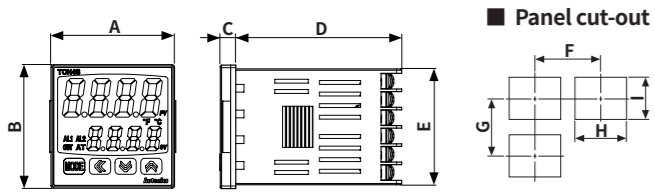

### Panel cut-out

	Body				Panel cut-out				
	A	B	C	D	E	F	G	H	I
TCN4S	48	48	6	64.5	44.8	≥ 65	≥ 65	45 <sup>+0.5</sup> <sub>0</sub>	45 <sup>+0.5</sup> <sub>0</sub>
TCN4S-P	48	48	7.7	65.8	44.8	≥ 65	≥ 65	45 <sup>+0.5</sup> <sub>0</sub>	45 <sup>+0.5</sup> <sub>0</sub>
TCN4M	72	72	6	64.5	67.5	≥ 90	≥ 90	68 <sup>+0.7</sup> <sub>0</sub>	68 <sup>+0.7</sup> <sub>0</sub>
TCN4H	48	96	6	64.5	91.5	≥ 65	≥ 115	45 <sup>+0.6</sup> <sub>0</sub>	92 <sup>+0.8</sup> <sub>0</sub>
TCN4L	96	96	6	64.5	91.5	≥ 115	≥ 115	92 <sup>+0.8</sup> <sub>0</sub>	92 <sup>+0.8</sup> <sub>0</sub>

## Bracket

### TCN4S

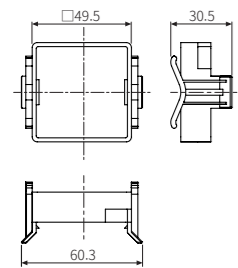

### Other series

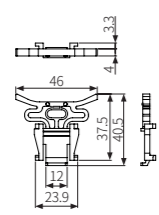

## Installation Method

### TCN4S

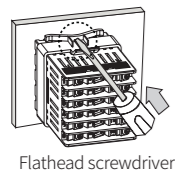

Flathead screwdriver

### Other series

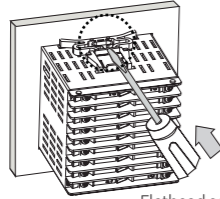

Flathead screwdriver

Insert the unit into a panel, fasten the bracket by pushing with a flathead screwdriver.

## Crimp Terminal Specifications

- Unit: mm, Use the crimp terminal of follow shape.

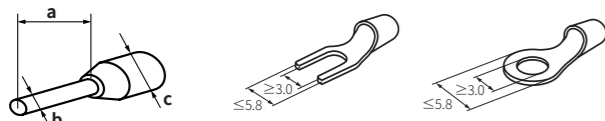

### Wire ferrule

Terminal number	a	b	c
1 to 8	6	≤ 1.7	≤ 3.7
9 to 11	6 to 8	≤ 2.1	≤ 4.2
12 to 14	6 to 8	≤ 1.5	≤ 3.5

### Fork crimp terminal

Terminal number	a	b	c
1 to 8	6	≤ 1.7	≤ 3.7
9 to 11	6 to 8	≤ 2.1	≤ 4.2
12 to 14	6 to 8	≤ 1.5	≤ 3.5

### Round crimp terminal

Terminal number	a	b	c
1 to 8	6	≤ 1.7	≤ 3.7
9 to 11	6 to 8	≤ 2.1	≤ 4.2
12 to 14	6 to 8	≤ 1.5	≤ 3.5

## Connections

### TCN4S

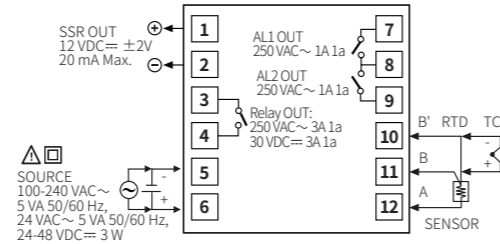

### TCN4S-P

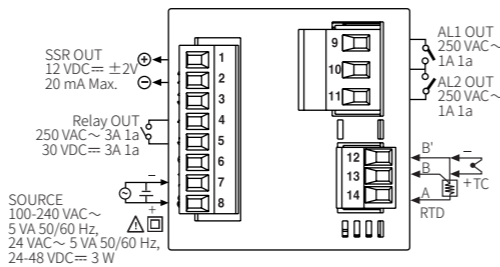

### TCN4M

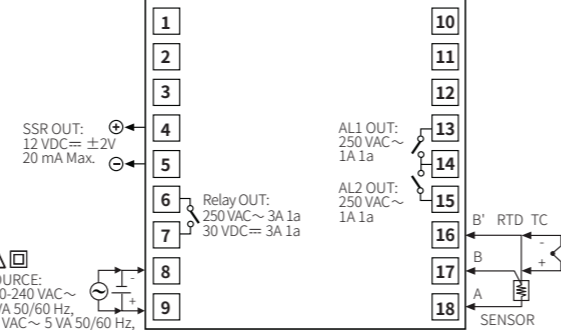

### TCN4H/L

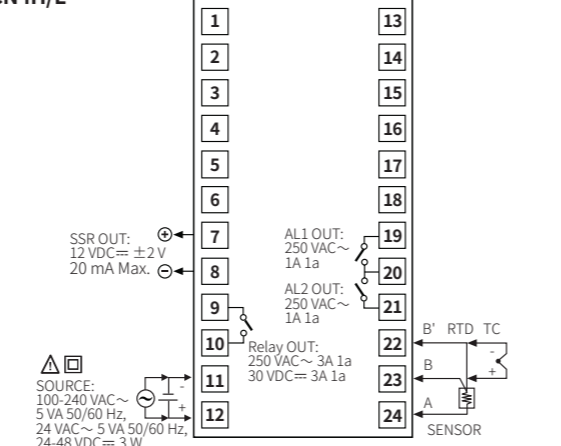

## Mode Setting

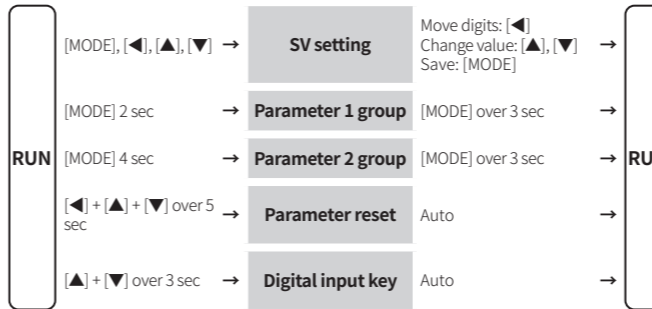

## Parameter Setting

- Some parameters are activated/deactivated depending on the model or setting of other parameters. Refer to the description of each item.
- The setting range in parentheses is for using the decimal point display in the input specification.
- If there is no key input for more than 30 seconds in each parameter, it returns to RUN mode.
- When pressing the [MODE] key within 1 second after returning to the operation mode from the parameter group, it will enter the parameter group before returning.
- [MODE] key: Saves the current parameter setting value and moves to the next parameter.
- [◀] key: Checks the fixed item / Moves the row when changing the set value
- [▲], [▼] keys: Selects the parameter / Changes the set value
- Recommended parameter setting sequence: Parameter 2 group → Parameter 1 group → SV setting mode

### Parameter 1 group

Parameter	Display	Default	Setting range	Condition
1-1 AL1 alarm temperature	RL 1	125.0	Deviation alarm: -F.S. to F.S. °C/°F Absolute value alarm: Within input range	2-12/14 alarm operation: AM1 to AM6
1-2 AL2 alarm temperature	RL 2	125.0		
1-3 Auto tuning	RL t	OFF	OFF: Stop, ON: Execution	2-8 Control type: PID
1-4 Proportional band	P	10.0	0.1 to 999.9 °C/°F	
1-5 Integral time	I	0.000	0 (OFF) to 9999 sec	
1-6 Derivative time	d	0.000	0 (OFF) to 9999 sec	
1-7 Manual reset	r E St	0.500	0.0 to 100.0%	2-8 Control type: PID & 1-5 Integral time: 0
1-8 Hysteresis	HY 5	0.02	1 to 100 (0.1 to 50.0) °C/°F	2-8 Control type: ONOF

### Parameter 2 group

Parameter	Display	Default	Setting range	Condition
2-1 Input specification <sup>01)</sup>	I n - t	ℓ C RH	Refer to 'Input Type and Using Range'.	-
2-2 Temperature unit <sup>02)</sup>	U n i t	°C	°C, °F	-
2-3 Input correction	I n - b	0000	-999 to 999 (-199.9 to 999.9) °C/°F	-
2-4 Input digital filter	ñ R w F	000.1	0.1 to 120.0 sec	-
2-5 SV low limit <sup>02)</sup>	L - Sv	- 5.0	Within 2-1 Input specification Input range, L-SV ≤ H-SV - 1-digit °C/°F H-SV ≥ L-SV + 1-digit °C/°F	-
2-6 SV high limit <sup>02)</sup>	H - Sv	120.0		-
2-7 Control output mode <sup>03)</sup>	o - F t	HE RE	HEAT: Heating, COOL: Cooling	-
2-8 Control type <sup>04)</sup>	C - n d	P i d	PID, ONOF: ON/OFF	-
2-9 Control output	o U t	r L Y	RLY: relay, SSR	-
2-10 SSR drive output type	S S r - ñ	S t n d	[AC model] STND: standard, CYCL: cycle, PHAS: phase	2-9 Control output: SSR
2-11 Control cycle	t	2.0	0.5 to 120.0 sec	2-9 Control output: RLY 2-10 SSR drive output type: STND 2-9 Control output: SSR 2-10 SSR drive output type: STND
2-12 AL1 alarm operation	RL - I	RL LR	□□□ AM0: Off AM1: Deviation high limit alarm AM2: Deviation low limit alarm AM3: Deviation high, low limit alarm AM4: Deviation high, low reverse alarm AM5: Absolute value high limit alarm AM6: Absolute value low limit alarm SBA: Sensor break alarm LBA: Loop break alarm (LBA)	-
2-13 AL1 alarm option	□□□	□□□	A: Standard alarm B: Alarm latch C: Standby sequence 1 D: Alarm latch and standby sequence 1 E: Standby sequence 2 F: Alarm latch and standby sequence 2 • Enter to option setting: Press [◀] key in 2-12 AL-1 alarm operation.	-
2-14 AL2 alarm operation	RL - 2	RL LR	Same as 2-12/13 AL1 alarm operation/option	-
2-15 AL2 alarm option	□□□	□□□		-
2-16 Alarm output hysteresis	RHY 5	0.0	1 to 100 (0.1 to 50.0) °C/°F	2-12/14 AL1/2 alarm operation: AM1 to 6
2-17 LBA time	L b R t	0000	0 (OFF) to 9999 sec or auto (auto tuning)	2-12/14 AL1/2 alarm operation: LBA
2-18 LBA band	L b R b	0002	0 (OFF) to 999 (0.0 to 999.9) °C/°F or auto (auto tuning)	2-12/14 AL1/2 alarm operation: LBA & 2-18 LBA time: > 0
2-19 Digital input key	d I - ℓ	St o P	STOP: Stop control output, AL.RE: Alarm reset, AT*: Auto tuning execution, OFF	*2-8 Control type: PID
2-20 Sensor error MV	E r - ñ v	0000	0.0: OFF, 100.0: ON 0.0 to 100.0%	2-8 Control type: ONOF 2-8 Control type: PID
2-21 Lock	L o C	o F F	OFF LOC1: Parameter 2 group lock LOC2: Parameter 1/2 group lock LOC3: Parameter 1/2 group, SV setting lock	-

01) Below parameters are initialized when the setting value is changed.  
- Parameter 1 group: AL1/2 alarm temperature  
- Parameter 2 group: Input correction, SV high/low limit, Alarm output hysteresis, LBA time, LBA band  
- SV setting mode: SV

02) If SV is lower than low limit or higher than high limit when the value is changed, SV is changed to the low/high limit value.  
If 2-1 Input specification is changed, the value is changed to Min./Max. value of Input specification.

03) When the setting value is changed, setting value of 2-20 Sensor error MV is initialized to 0.0 (OFF).

04) When changing the value from PID to ONOF, each value of following parameter is changed.  
2-19 Digital input key: OFF, 2-20 Sensor error MV: 0.0 (when setting value is lower than 100.0)