

High speed response time 0.1 ms/ON.
 Free cut fiber cable.
 DIN rail fixer.
 Thermal drift less than $1\mu m^{\circ}C$
 Illumination over 10,000 Lux of lamp light.
 Fiber sensor with high repetitive $5\mu m$.

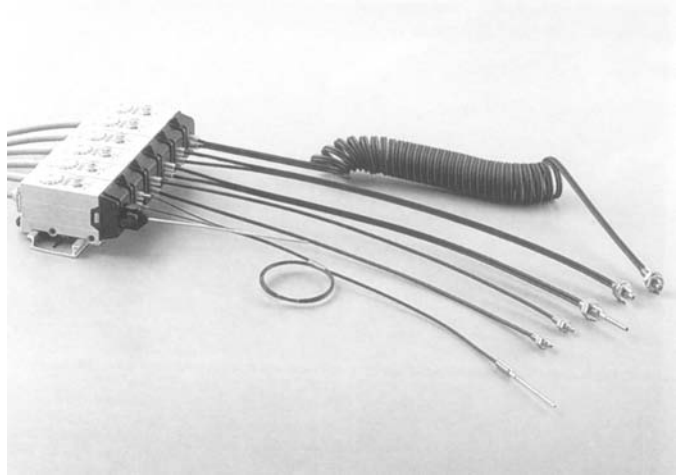

■ Specification < Amplifier Unit >

Output Method	Standard Type		Long Distance Type	
Model	FF-03R	FF-03X	FF-06R	FF-06X
Emitter	Red LED	Infrared LED	Red LED	Infrared LED
Response Time	ON : 0.1ms , OFF : 0.15ms			
Hysteresis	< 5% of Sensing Distance			
Operating Voltage	11~30 VDC ; Ripple < 20% of Peak to Peak			
Current Consumption	30 mA max.		40 mA max.	
Residual Voltage	< 0.8V			
Leakage Current	< 0.8mA			
Output Method	NPN & PNP Two Way Output			
Output Status	NO/NC Changeable			
Output Current	150mA max.			
Protection Method	Short Circuit & Polarity Reversed Protection			
Connection Method	4 Cores / 5.0 φ X 2m			
Protect Class	IP-65			
Illumination	Lamplight < 5,000 Lux ; Sunlight < 10,000 Lux.			
Operating Temp./Hum.	-20°C~+70°C ; 35%~85% RH			
Housing Material	PBT			
Weight	Appr. 105g			

Output Circuit & Connection Diagram

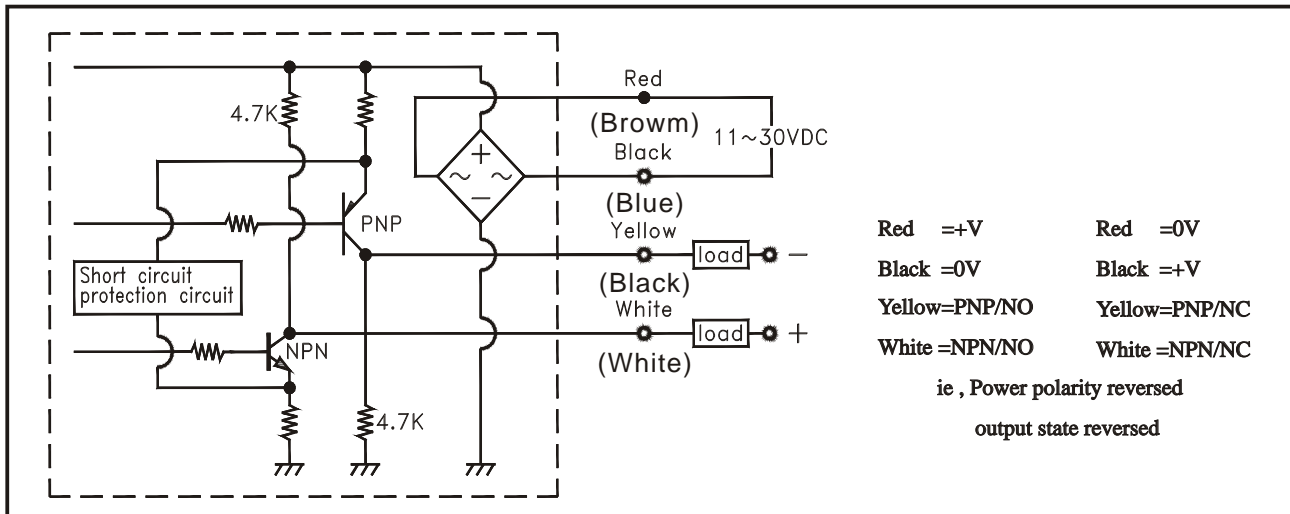

Dimension < Amplifier Unit >

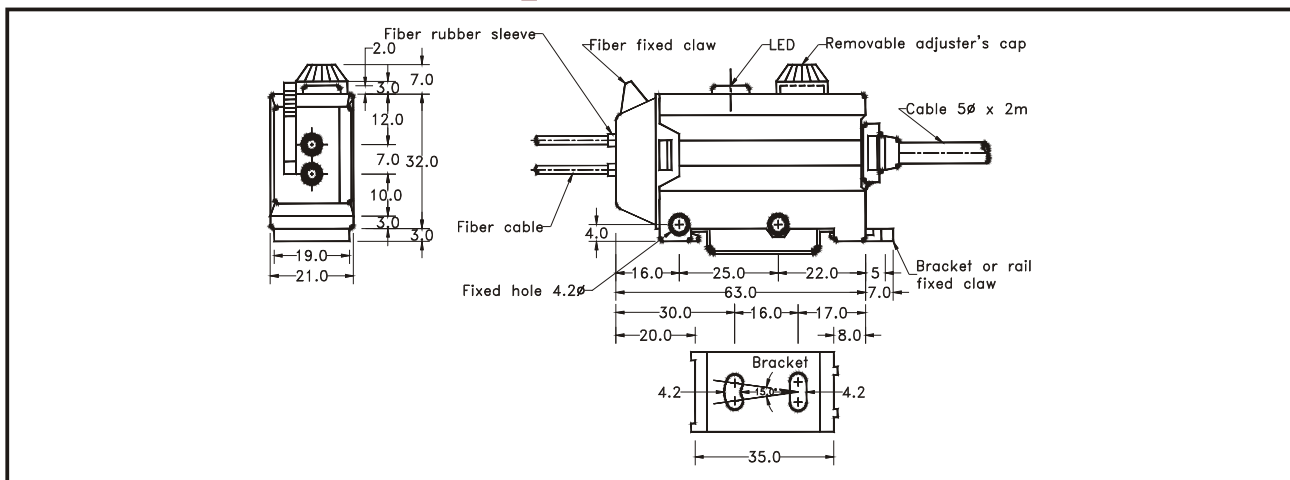





Attachment < Lens >

Type	Right View Lens		Aside View Lens	
Model	FL-1		FL-2	
Shape				
Suitable fiber unit	FPT-02			
Amplifier	FF-03R (X)	FF-06R (X)	FF-03R (X)	FF-06R (X)
Sensing distance	1200mm	2000mm	400mm	600mm
Min. sensible object	1 φ			

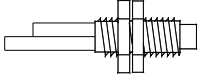
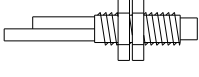
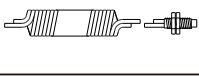
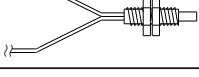
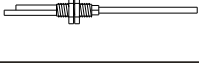
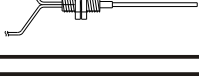
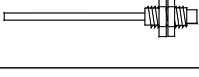
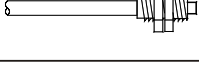
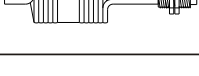
FPR/FPT series

FIBER CABLE UNIT

Type	Mode	Model	Fiber shape	Amplifier	Min. detectable object	Sensing distance	Operating temperature	Fiber material
Relreflex Type	M6 1.0 φ X 2	FPR-51		mF-06R	0.03 φ	65mm	-40°C +70°C	Poly- plastic
	M6 1.0 φ X 1 0.25 φ X 15	FPR-52		mF-06R	0.03 φ	65mm		
	M6 1.0 φ X 2	FPR-53		mF-06R	0.03 φ	30mm		
	M6 0.5 φ X 2	FPR-54		mF-06R	0.03 φ	45mm		
	M6 1.0 φ X 2	FPR-55		mF-06R	0.03 φ	65mm		
	M4 0.5 φ X 2	FPR-56		mF-06R	0.03 φ	45mm		
Thru Beam Type	M4 0.5 φ X 1	FPT-01		mF-06R	0.5 φ	100mm	-40°C +70°C	Poly- plastic
	M4 1.0 φ X 1	FPT-02		mF-06R	0.5 φ	300mm		
	M4 1.0 φ X 1	FPT-03		mF-06R	0.5 φ	100mm		
	M4 1.0 φ X 1	FPT-04		mF-06R	0.5 φ	250mm		
	M4 0.5 φ X 1	FPT-05		mF-06R	0.5 φ	250mm		
	M3 0.5 φ X 1	FPT-06		mF-06R	0.5 φ	150mm		

Dimension

Reflex Type

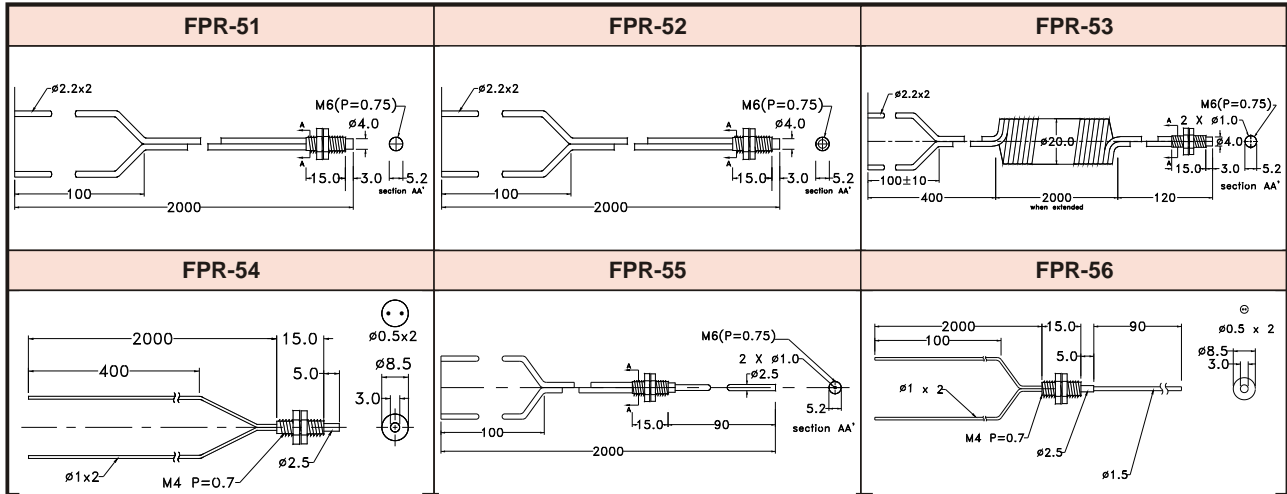

Thru Beam Type

