

Photo sensor PAN series

INSTRUCTION MANUAL

Thank you for purchasing HANYOUNG product.
Please check whether the product is the exactly same as you ordered.
Before using the product, please read this instruction manual carefully.
Please keep this manual where you can view at any time



HANYOUNG NUX CO.,LTD
28, Gilpa-ro 71beon-gil, Nam-gu, Incheon, Korea
TEL : (82-32)876-4697 FAX : (82-32)876-4696
http://www.hynux.net

PT. HANYOUNG ELECTRONIC INDONESIA
JL.CEMPAKA BLOK F 16 NO.02 DELTA SILICON II
INDUSTRIAL PARK LIPPO CIKARANG
CICALI, CIKARANG PUSAT, BEKASI INDONESIA 17550
TEL : 62-21-8911-8120~4 FAX : 62-21-8911-8126



Safety information

Before using the product, please read the safety information thoroughly and use it properly.
Alerts declared in the manual are classified to Danger, Warning and Caution by their criticality

DANGER	DANGER indicates an imminently hazardous situation which, if not avoided, will result in death or serious injury
WARNING	WARNING indicates a potentially hazardous situation which, if not avoided, could result in death or serious injury
CAUTION	CAUTION indicates a potentially hazardous situation which, if not avoided, may result in minor or moderate injury

Warning

- The contents of this manual may be changed without prior notification.
- To prevent deflection or malfunction of this product, supply proper power voltage in accordance with the rating.
- Since this product is not designed with explosion-protective structure, do not use it at any place with flammable or explosive gas.
- Remove this product while the power is off. Otherwise, it may cause malfunction or electric shock.
- Due to the danger of electric shock, use this product installed onto a panel while an electric current is applied.
- To avoid electric shock, use this product installed on the panel, please.
- This product is not for press safety sensors.
- This product does not have control of the disaster prevention and accident prevention.
- Please note that this product does not guarantee for any damages due to adisaster or an accident on the machine using this product.

Caution

- The contents of this manual may be changed without prior notification.
- If you use the product with methods other than specified by the manufacturer, there may be bodily injuries or property damages.
- Do not decompose, modify, revise or repair this product. This may be a cause of malfunction, electric shock or fire.
- Make sure that there is no damage or abnormality of the product during delivery.
- Do not use this product at any place with a large inductive difficulty or occurring static electricity or magnetic noise.
- Do not use this product at any place with possible thermal accumulation due to direct sunlight or heat radiation.
- When the product gets wet, the inspection is essential because there is a danger of electric leakage or fire.
- Do not connect anything to the unused terminals.
- After checking the polarity of terminal, connect wires at the correct position.
- For the continuous and safe use of this product, the periodical maintenance is recommended.
- Make its wiring be shorter as possible and wire extension shall be within 100 m.
- Avoid continuously switching the power source On and Off.
- Use a dry cloth to wipe off the substance when cleaning the lens or cases. Never use thinner or organic solvents.
- Do not use this product at any place with much dust, vibration or impact.
- Before inserting power source, make sure that the circuit wiring is properly connected.
- In the case of wiring loaded inductors such as DC Relay and others to output, use diode, varistor and others to prevent surge.
- To avoid malfunction caused by noise, do not put high voltage or power line with sensor wire in a same conduit
- Prevent strong disturbance light such as sunlight and others which directly enter into the directional angle of the sensor by putting a glare shield.
- When using the Switching Power Supply as the power source, earth the Frame Ground (F.G) terminal and be sure to connect the noise-eliminating condenser between 0 V and F.G.

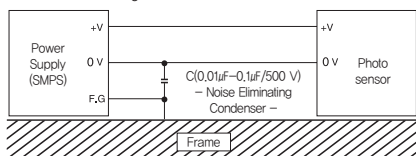

※ If you do not follow the contents described in the safety information then it is possible to be a cause of the product's malfunction so please follow them.

Feature

- Implementation of Minimum beam pitch 10 mm, maximum beam pitch 40 mm, theoretical axis until the maximum number of beam channels 96.
- Detection area offers a variety of detection width of 140 mm ~ 940 mm
- Two sets of parallel installation of mutual interference prevention function
- A / O provides the user with two modes of operation can be set to suit your needs to use.
- Easy verification and maintenance and fault diagnosis with operation displaying Error display.

Suffix code

Model	Code	Information
PAN-	□ □ □ □	Area sensor
Optical axis pitch	20	20 / 40 mm
Sensing method	T	Through Beam
Number of optical axis	16	Number of optical axis (Please refer to the dimension)
Output	N	NPN open collector
	P	PNP open collector

Output Circuit

- NPN Open Collector Output (N TYPE)**
- PNP Open Collector Output (P TYPE)**

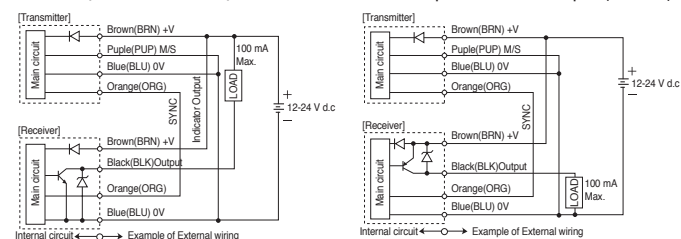

Specification

Type	Through beam	
Model	NPN	PAN20-T □□□
	PNP	PAN20-T □□P
Sensing distance	7 m	
Sensing object	Opaque object above Ø32 mm	Opaque object above Ø52 mm
Optical axis pitch	20 mm	40 mm
Power supply voltage	12 - 24 V d.c ± 10 %	
Current consumption	170 mA max	100 mA max
Output	NPN/PNP open collector output, max 100 mA (30 V d.c) Inductive load : 50 mA, Remaining voltage : 0.5 V d.c max	
Operation mode	Transmitter : select the master/slave operation (mutually preventing interference function) Receiver : A mode (ON when all optical axis L,ON) O mode (select ON when 1 optical axis L,ON)	
Response Time	15 ms max	7 ms max
Light source (wave length)	Infrared LED (wave 850 nm)	
LED	Transmitter : Power indicator(Green LED), M/S display(Red LED) Receiver : Light on stability display(Green LED), output Display(Red LED) E1 display(Red LED), E2 display(Blue LED)	
Ambient illumination	Sunlight : max 10,000 Lux, Incandescent lamp : max 3,000 Lux	
Ambient temperature	-10 ~ 55 °C (Surrounding storage temperature : -25 ~ 70 °C)	
Ambient humidity	35 ~ 85 % R.H. (With no condensation)	
Protective structure	IP65 (IEC)	
Vibration resistance	10 - 55 Hz, Double amplitude : 1.5 mm, for 2 hours in X, Y and Z direction	
Dielectric strength	500 V a.c 50/60 Hz for 1 min	
Insulation resistance	20 MΩ min. (500 V d.c between the code and case) between adjustment switch and case	
Connection method	Connector code extended type, code length : 200 mm, Number of wires : 5P, Dimension : Ø5.5 mm connector	
Material	Case : aluminum, front cover and lens : acryl	
Operation S/W	Trns : M/S Operation conversion S/W, Rcvr : A/O Operation conversion S/W	
Protection	Interference protection (M/S MODE), Output protection	

- Please take precautions since the detection distance can vary depending on the size and surface condition of the detected object and the presence of gloss.
- PAN20-TL8 (light projector) and PAN20-TR8N (Receiver) comprise one set of PAN20-T8N.
- PAN40-T32 is customizing product.

Production formation

Series	Model	Detection	Sensing Distance	Number of optical axes	Detecting	Current consumption (mA max)	Detectable object
PAN20	PAN20-T8	Through Beam	7 m	8 EA	140 mm	70 mA	Opaque object above Ø32 mm
	PAN20-T12			12 EA	220 mm	80 mA	
	PAN20-T16			16 EA	300 mm	90 mA	
	PAN20-T20			20 EA	380 mm	100 mA	
	PAN20-T24			24 EA	460 mm	110 mA	
	PAN20-T28			28 EA	540 mm	120 mA	
	PAN20-T32			32 EA	620 mm	130 mA	
	PAN20-T36			36 EA	700 mm	140 mA	
	PAN20-T40			40 EA	780 mm	150 mA	
	PAN20-T44			44 EA	860 mm	160 mA	
	PAN20-T48			48 EA	940 mm	170 mA	
	PAN40			PAN40-T4	Through Beam	7 m	
PAN40-T6		6 EA	200 mm	55 mA			
PAN40-T8		8 EA	280 mm	60 mA			
PAN40-T10		10 EA	360 mm	65 mA			
PAN40-T12		12 EA	440 mm	70 mA			
PAN40-T14		14 EA	520 mm	75 mA			
PAN40-T16		16 EA	600 mm	80 mA			
PAN40-T18		18 EA	680 mm	85 mA			
PAN40-T20		20 EA	760 mm	90 mA			
PAN40-T22		22 EA	840 mm	95 mA			
PAN40-T24		24 EA	920 mm	100 mA			
PAN40-T32		32 EA	1240 mm	125 mA			

• Output type is NPN and PNP.

Characteristic Graph

- Parallel Shift Characteristic
- PAN20/40 series

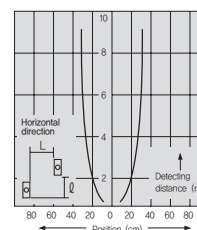
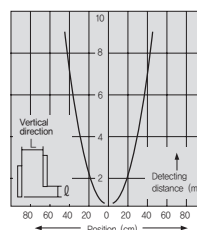

Angle Characteristic

● PAN20/40 series

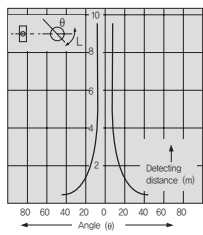

● PAN20 series

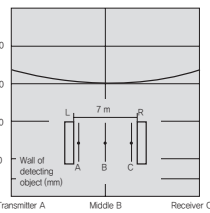

● PAN40 series

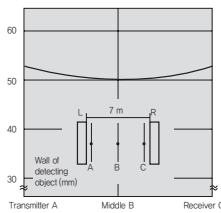

Dimension

■ PAN20 series

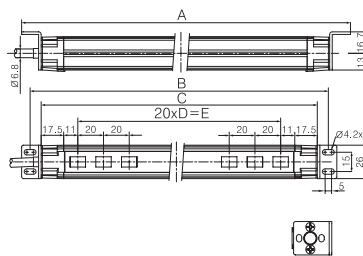

Type	A	B	C	D	E
PAN20-T8	227	214.2	197	7	140
PAN20-T12	307	294.2	277	11	220
PAN20-T16	387	374.2	357	15	300
PAN20-T20	467	454.2	437	19	380
PAN20-T24	547	534.2	517	23	460
PAN20-T28	627	614.2	597	27	540
PAN20-T32	707	694.2	677	31	620
PAN20-T36	787	774.2	757	35	700
PAN20-T40	867	854.2	837	39	780
PAN20-T44	947	934.2	917	43	860
PAN20-T48	1027	1014.2	997	47	940

■ PAN40 series

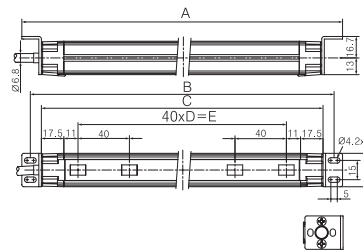

Type	A	B	C	D	E
PAN40-T4	207	194.2	177	3	120
PAN40-T6	287	274.2	257	5	200
PAN40-T8	367	354.2	337	7	280
PAN40-T10	447	434.2	417	9	360
PAN40-T12	527	514.2	497	11	440
PAN40-T14	607	594.2	577	13	520
PAN40-T16	687	674.2	657	15	600
PAN40-T18	767	754.2	737	17	680
PAN40-T20	847	834.2	817	19	760
PAN40-T22	927	914.2	897	21	840
PAN40-T24	1007	994.2	977	23	920
PAN40-T32	1327	1314.2	1297	31	1240

Indicator & Wiring diagram

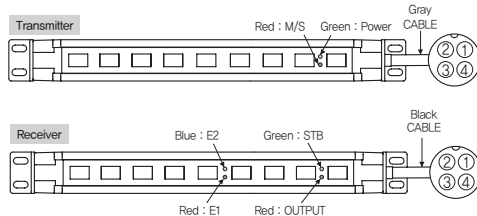

■ Operation LED (Transmitter)

LED indicator	Transmitter
Red (M/S)	LED output L_OFF when operation the MASTER / LED output L_ON when operating the SLAVE
Green (Power)	Power indicator

LED indicator	Receiver
Red (OUTPUT)	Output indicator
Green (STB)	L_ON stability indicator
Red (E1)	L_OFF with the disconnection or break of cluck (sync signal)/reset signal wire
Blue (E2)	L_OFF with the appearance of disturbance light such as mercury lamp, luminescent light and etc.

■ Wiring and connecting classification (Transmitter)

PIN NO.	Wiring color	Transmitter	PIN NO.	Wiring color	Receiver
1	Brown	Power (12 - 24 V d.c)	1	Brown	Power (12 - 24 V d.c)
2	Orange	동기선	2	Orange	Sync wire
3	Blue	GND	3	Blue	GND
4	Purple	M/S	4	Black	Output

Operation chart

Operation Mode	Detection status	An amount of L_ON	Safety region operation region	Waveform
Output Becomes ON when an amount of entered light is more than all optical axes (A operation mode)	Operation indicator (Red LED)	ON	OFF	[Waveform]
	Control output	ON	OFF	[Waveform]
	Stable indicator (Green LED)	ON	OFF	[Waveform]
	Disturbance light	ON	OFF	[Waveform]
	E2 indicator (Blue LED)	ON	OFF	[Waveform]

(Cautions) Green LED of light source is the power indication.

- E1 light (red LED) on the detector is put out when the baseline is short-circuited.
- E2 light (blue LED) on the detector is put out under the outer light such as sunlight and fluorescent light. (Please be cautious since there is possibility of malfunction when E2 light is put out.)
- Refer to Motion Mode

Master/slave connection diagram

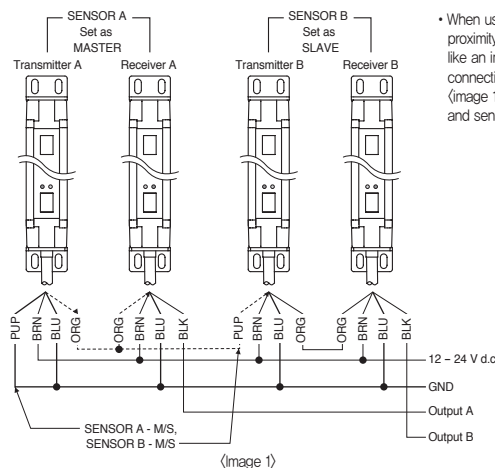

- When using 2 set of the sensor in proximity distance, please set them just like an image below. Depending on the connection method given in the (Image 1), please connect the sensor A and sensor B individually.

- Please open the screw cover (bottom connector side of transmitter) by flat-head screw driver and makes the operation mode converting switch to just like an image 2. Please set the transmitter A as M (Master) and transmitter B as S (Slave).
- Default = M (Master)

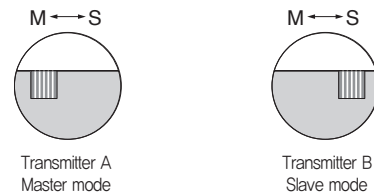

(Image 2)

Caution

- In case of using the set of two, distribute the wires so that both won't be either M Mode motion or S Mode motion at the same time.
- Please do not mutually connect the baseline (orange) of Sensor A and Sensor B.

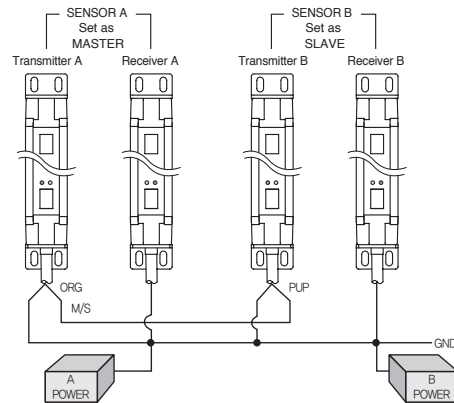

(Image 3)

- Please verify the M/S light of the light projector after the power input. Light Projector A (M Motion) : M/S Light On, Light Projector B (S Motion) : M/S Light Off

Operation Mode

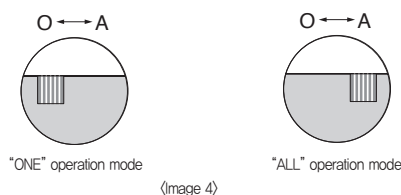

(Image 4)

- Please open the screw cover (use flat driver) which located on the bottom connector side of the receiver and convert the operation mode converting switch to the mode that is suitable to the operation condition and use it.
- Default mode : A operation mode (all optical axes L_ON then ON operates)
 A operation mode : all optical axes L_ON - output ON (L_OFF above 1 optical axis - output OFF)
 O operation mode : all optical axes L_OFF - output OFF (L_ON above 1 optical axis - output ON operation)

Panel & Optical Axis Adjustment

- Verify the lighting of power light (green) of the light projector after verifying the connection condition and power input.
- Move the light projector to the directions of left, right, up and down to turn on the Light On Stable Light (green) of Receiver.