

Low voltage

Acti 9

the efficiency you deserve

Catalogue
09/2013

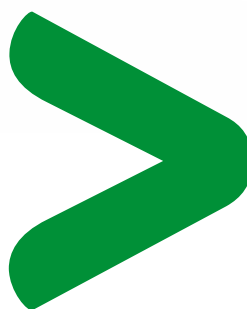

General**Principle of catalogue numbers, protection (Acti 9)**

CA901009E 1

Circuit protection

Choice of circuit protective devices

CA901011E 2

Circuit breaker panorama

CA901000E 4

Neutral breaking circuit breakers

i DPN, DT40, DT60, C40 (Clario, Libro, Prodis)

CA901012E 14

Circuit breakers up to 63 A

iC60a

CA901010E 26

iC60N

CA901002E 31

iC60N double terminals

CA901019E 40

iC60H

CA901003E 45

iC60H double terminals

CA901020E 54

iC60L

CA901004E 58

iK60 (B curve)

CA901006E 61

iK60 (C curve)

CA901007E 64

iK60 Biconnect

CA901027E 70

Circuit breakers up to 125 A

C 120a, N, H (RSA)

CA901017E 73

C 120N

CA901015E 78

C 120H

CA901016E 82

High performance circuit breakers

NG125a

CM901027E 85

NG125N

CM901028E 89

NG125H

CM901029E 95

NG125L

CM901030E 99

Direct current circuit breakers

C60H-DC

CA901024E 105

C60PV-DC

CA901031E 108

C60NA-DC

CA901032E 112

SW60-DC

CA901030E 116

Motor protection circuit breakers

P25M

CM901026E 120

iC60LMA

CA901005E 125

NG125LMA

CM901031E 128

Fuses

STI

CM901033E 132

DO fuse disconnectors switches (projet Dido)

CA901035E 135

Fuse holder with indicator light SBI

CM901034E 137

Residual current devices

Choice of earth leakage protection devices

CA902000E 140

Overview of the earth leakage protection product range

CA902011E 142

Residual current circuit breakers

iID

CA902002E 145

iID double terminals

CA902018E 161

iID K

CA902007E 167

iID K biconnect

CA902027E 171

IDc, ITG40, ID C40 (Clario, Libro, Prodis)

CA902012E 173

RCCB-ID 125 A

CM902001E 178

RCCB-ID type B

CM902002E 180

Add-on residual current devices for circuit breakers

Vigi iC60

CA902005E 182

Vigi iC60 double terminals

CA902019E 193

Vigi C120

CA902016E 199

Vigi NG125

CM902008E 204

Residual current devices

iDPN Vigi

CA902026E 214

i DPN Vigi, Vigi i DPN, Vigi TG40, Vigi TG60, DT40 Vigi, Vigi DT40, Vigi C40, C40 Vigi (Clario, Libro, Prodis)

CA902013E 217

DPNa Vigi, DPN N Vigi

CA902014E 227

DPN Vigi K

CA902032E 231

SPN N Vigi

CA902017E 233

DPN N Vigi

CA902037E 235

REDs, REDtest

CM902017E 237

Load protection (surge arrester)**LV surge arresters**

Choice of surge arresters

CA903010E 244

iPRF1 - PRF1 - PRD1

CA903005E 248

iPF

CA903001E 254

iPRD Acti 9

CA903008E 258

iPRD (white product)

CA903002E 264

iQuick PRD

CA903003E 268

iQuick PF

CA903004E 271

Surge arresters for telephon and informatic networks

iPRC/iPRI

CA903006E 273

Surge arresters for photovoltaic installations

iPRD-DC PV (white product)

CA903007E 275

iPRD-PV-DC

CA903009E 278

Disconnection**Switch-disconnectors**

iSW Acti 9

CA904027E 282

SW Biconnect switches

CA904030E 288

Trip switch-disconnectors

iSW-NA

CA904013E 290

NG125NA

CM901035E 292

Install, connection, power distribution

Accessorisation/Auxiliarisation

Accessories / Auxiliarisation iC60, iID, iSW-NA, Reflex iC60, RCA, ARA
Accessories and auxiliaries for C120, Vigi C120, DPN, C60H-DC devices
Accessories and auxiliaries for NG125 devices

Circuit breakers and residual current devices accessories

Accessories for iC60, iID, iSW-NA, Reflex iC60, RCA, ARA
Accessories for DT60

Accessories for C120, DPN, DPN Vigi, C60H-DC devices

Accessories for NG125 devices

Comb busbar and devices feeders

Linerigy FH et FV: Horizontal and vertical comb busbars

Linerigy DX : Quick distribution blocks

Linerigy FM: Quick device feeders

Linerigy DS: Devices feeders

Supervision and switchboard control

Acti 9 control system

Smartlink Acti 9

Monitoring and control of protections

Indication and tripping

Electrical auxiliaries for iC60, iID, iSW-NA, RCA, ARA
Electrical auxiliaries for C120, DPN, DPN Vigi, ID, C60H-DC devices
Electrical auxiliaries for NG125 devices

Remote control

RCA remote controls for iC60 circuit breakers

Automatic reclosers

ARA automatic reclosers for iC60 and iID

Electrical circuit control

Manual control

iPB pushbuttons

iSSW linear switches

DIN rail selector switches iCMB, iCMD, iCME, iCMC, iCMV and iCMA

Button holders

Electrical control

Reflex iC60 integrated control circuit breakers

iCT contactors

iTL impulse relays

TL impulse relays (Clario, Libro, Prodis)

CT contactors (Clario, Libro, Prodis)

TL+ impulse relays

CT+ contactors

Indication

Indicators

iLL indicator lights

iSO bells and iRO buzzers

iTR transformers

Lighting, time and energy management

Relays iRTA, iRTB, iRTC, iRTH, iRTL, iRTMF, iRBN, iRTBT, iRLI, iERL, iRCP, iRCI, iRCU, iRCC

CDS load-shedding

Modular iPC power sockets

Kilowatt-hour meters iEM, iME

Complementary technical information

400 Hz network

Influence of ambient temperature

Dissipated power, Impedance and Voltage drop

Resistance to environmental conditions

Circuit protections

Tripping curves

Short-circuit current limiting

Cascading

Protection discrimination

Circuit breakers for direct current applications

Direct current distribution

Motor protections

Motor circuit protection and contactor combination

Photovoltaic

Examples of installation architectures

Acti 9 Smartlink

Acti 9 Smartlink installation

Earth leakage protections

Routine operating checks

Response time of high-sensitivity residual current devices

Response time of medium-sensitivity residual current devices

Electrical and electromagnetic interference

Co-ordination

DCP Vigi RCBO

Fuses

SBI/STI curves

Impulse relays, contactors

iTL impulse relays and iCT contactors, choice of rating according to load type

Auxiliaries

Auxiliary indicating contacts for Acti 9 protective devices

Auxiliary trip units for Acti 9 protective devices

Combination electrical auxiliaries for iC60, iID, iSW-NA, ARA and RCA

Twilight and time switches, timers, thermostats

IC twilight switches

IHP, ITM time switches

MIN timers

STD, STU dimmers

TH4, TH7, THP1, THP2 thermostats

| | |
|------------|-----|
| CA907000E | 298 |
| CA907013E | 305 |
| CM907004E | 311 |
| CA907001E | 312 |
| CA907011E | 318 |
| CA907012E | 320 |
| CM907006E | 324 |
| LIN001 | 326 |
| LIN003 | 334 |
| LIN022 | 336 |
| CA907023E | 338 |
| CA907019E | 341 |
| CA907002E | 347 |
| CA907008E | 355 |
| CM907005E | 361 |
| CA904011E | 365 |
| CA904010E | 370 |
| CA904003E | 375 |
| CA904004E | 376 |
| CA904024E | 378 |
| CA907007E | 381 |
| CA904012E | 382 |
| CA904007E | 387 |
| CA904008E | 404 |
| CA904020E | 417 |
| CA904021E | 423 |
| CA904018E | 429 |
| CA904019E | 431 |
| CA904006E | 433 |
| CA904014E | 434 |
| CA904015E | 435 |
| CA904022E | 438 |
| CA904023E | 447 |
| CA904017E | 453 |
| CA904009E | 456 |
| CA908005E | 460 |
| CA908007E | 462 |
| CA908009E | 470 |
| CA908027E | 472 |
| CA908024E | 474 |
| CA908025E | 483 |
| 557E4200 | 501 |
| 557E4300 | 539 |
| 557E4305 | 546 |
| 557E4310 | 580 |
| 557E4330 | 587 |
| CA908036E | 607 |
| CA908032E | 609 |
| CA908006E | 627 |
| CA908022E | 653 |
| CA908035E | 654 |
| CA908033E | 660 |
| CA908012E | 663 |
| CA908013E | 666 |
| CA908018E | 667 |
| CA908015E | 671 |
| CA908023E | 674 |
| CM902006E | 681 |
| CM908003E | 691 |
| CA908026E | 695 |
| CA908028E | 700 |
| CA908029E | 703 |
| CA908030E | 710 |
| LSB02323EN | 712 |
| LSB02322EN | 720 |
| LSB02321EN | 735 |
| LSB02325EN | 739 |
| LSB02324EN | 744 |



Choice of sensitivity

The sensitivity of an earth leakage protection device depends mainly on the function it has to perform:

- Protection from electric shock by direct contact.
- Protection from electric shock by indirect contact.
- Protection from fire due to current leakage.

The following table gives a reminder of:

- The circuits that must be protected against these various risks (obligation or recommendation).
- The type of earth leakage protection device to be used in each case, its sensitivity, and its location in the distribution diagram.

| Type of protection | Obligations | | Recommended by Schneider Electric | Sensitivity (I Δ n) | | |
|---|---|---|--|--|---|---|
| | National standard <i>To be filled in according to the country standard</i> | International standard IEC 60364 | | 30 mA (*) | 100 mA to 3000 mA (depending on the earthing system) | 300 mA (or 500 mA) |
| Protection from electric shock by direct contact | | | | | | |
|  DB123167 | <i>To be filled in according to the country standard</i> | Power supply for <ul style="list-style-type: none"> ■ General-purpose power sockets, up to 20 A ■ Appliances in the vicinity of a bathtub, shower, pond or swimming pool ■ Portable appliances for outdoor use, up to 32 A ■ Lighting for exhibition stands and shows ■ Outdoor lighting <i>To be modified according to national obligations (above)</i> | <ul style="list-style-type: none"> ■ Lighting in the home | Setup in final distribution switchboard <ul style="list-style-type: none"> ■ Residual current device protecting a circuit ■ Residual current circuit breaker protecting a group of circuits | | |
| Protection from electric shock by indirect contact | | | | | | |
|  DB123168 | <i>To be filled in according to the country standard</i> | The entire power distribution system, except for devices: <ul style="list-style-type: none"> ■ With class II insulation ■ Operating at Safety Extra Low Voltage (class III) <i>To be modified according to national obligations (above)</i> | – | Setup in final distribution switchboard <ul style="list-style-type: none"> ■ Residual current circuit breaker or device, on incoming feeder Setup in subdistribution board or main switchboard <ul style="list-style-type: none"> ■ Residual current device protecting a circuit ■ Residual current device or circuit breaker protecting a group of circuits ■ On incoming feeder: residual current circuit breaker or device | | |
| Protection from fire due to current leakage | | | | | | |
|  DB123169 | <i>To be filled in according to the country standard</i> | <ul style="list-style-type: none"> ■ High-risk premises: <ul style="list-style-type: none"> □ explosion (BE3) □ fire (BE2) ■ Agricultural and horticultural buildings ■ Equipment for fairs, exhibitions and shows ■ Temporary outdoor recreational installations <i>To be modified according to national obligations (above)</i> | <ul style="list-style-type: none"> ■ Dilapidated buildings or electrical installations ■ Humid atmospheres: agricultural buildings, public swimming pools ■ Presence of chemical agents | | | Setup in final distribution switchboard <ul style="list-style-type: none"> ■ Residual current circuit breaker or device, on incoming feeder Setup in subdistribution board or main switchboard <ul style="list-style-type: none"> ■ Residual current device protecting each circuit to a high-risk zone ■ Residual current device or circuit breaker protecting a group of circuits ■ On incoming feeder: residual current circuit breaker or device |

(*) The 10 mA sensitivity is useful for certain very specific applications, where there is a risk that someone could sustain a non-dangerous current (10 to 30 mA) without being able to get free. Example: healthcare equipment for hospital beds. Generally, devices with this very high sensitivity are liable to cause frequent tripping, due to the natural leakage currents of the installation.

Interference immunity

Schneider Electric provides various equipment technologies capable of overcoming the consequences of interference of all kinds.

| Operating conditions | | Examples | Types | | | | |
|-------------------------------|---|---|---|-------|--------|-------|---|
| | | | AC | A | SI | B | |
| Loads | | | | | | | |
| | With no special characteristics | <ul style="list-style-type: none"> General-purpose power sockets Incandescent lighting Household appliances: microwave oven, dishwasher, clothes dryer Electric heating, water heater | ■ | ■ | ■ | ■ | |
| | Including a rectifier | Single phase | <ul style="list-style-type: none"> Household appliances: induction cooking appliances, washing machines (variable speed) Single-phase variable speed drives | - | ■ | ■ | - |
| | | Three phase | <ul style="list-style-type: none"> Three-phase variable speed industrial drives Three-phase uninterruptible power supplies | - | - | - | ■ |
| | Generating high-frequency interference (current peaks, harmonics) | | <ul style="list-style-type: none"> Fluorescent lighting powered by extra low voltage transformer, by electronic ballast Variable luminosity lighting Powerful IT equipment Single-phase variable speed industrial drives Air conditioning Telecommunications equipment Capacitor banks | - | - | ■ | ■ |
| | Including an anti-harmonic filter in the power supply | | <ul style="list-style-type: none"> Microcomputer systems Computer peripherals (printers, scanners, etc.) | - | - | ■ | ■ |
| Electrical environment | | | | | | | |
| | Vicinity of equipment generating transient overvoltages | <ul style="list-style-type: none"> High-powered switching devices Reactive energy compensation banks | - | - | ■ | ■ | |
| | Circuits powered by an uninterruptible power supply "Isolated neutral" (IT) earthing system | <ul style="list-style-type: none"> Backed-up networks | - | - | ■ | ■ | |
| | Major risk of lightning strokes | <ul style="list-style-type: none"> Buildings protected by a lightning protection system Mountainous or humid regions Regions with high keraunic level | - | - | ■ | ■ | |
| Atmosphere | | | | | | | |
| | Ambient temperature which could be less than -5°C | - | - | ■ | ■ | ■ | |
| | Presence of corrosive agents (AF2 to AF4) or dust | <ul style="list-style-type: none"> Indoor swimming pools Yacht harbours, marinas, camping grounds Water treatment Chemical industries, heavy industries, paper mills Mines and cellars, road tunnels Markets, stock raising, food processing industries | - | - | ■ (1) | - | |

(1) SiE for C120 and NG125 circuit-breakers

Discrimination

Residual current devices of average sensitivity (100 mA and more) are available in a selective (S) and delayed (R) version. This option ensures that, in the event of an earth fault downstream of the installation, only the defective part is switched off. The table below shows (in green) which upstream/downstream equipment combinations provide this discrimination.

| Sensitivity (mA) - Downstream | | Sensitivity (mA) - Upstream | | | | | | | | | | | | |
|-------------------------------|---------------|-----------------------------|-----------|------|-----|------|------|-------------|-----|-----|-----------|------|------|------|
| | | Instantaneous | | | | | | Selective S | | | Delayed R | | | |
| | | 30 | 100 | 300 | 500 | 1000 | 3000 | 100 | 300 | 500 | 1000 | 3000 | 1000 | 3000 |
| | Instantaneous | 30 | - | - | - | - | - | - | - | - | - | - | - | - |
| | | 100 | - | - | - | - | - | - | - | - | - | - | - | - |
| | | 300 | - | - | - | - | - | - | - | - | - | - | - | - |
| | | 500 | - | - | - | - | - | - | - | - | - | - | - | - |
| | | 1000 | - | - | - | - | - | - | - | - | - | - | - | - |
| | | 3000 | - | - | - | - | - | - | - | - | - | - | - | - |
| | Selective S | 100 | - | - | - | - | - | - | - | - | - | - | - | |
| | | 300 | - | - | - | - | - | - | - | - | - | - | - | |
| | | 500 | - | - | - | - | - | - | - | - | - | - | - | |
| | | 1000 | - | - | - | - | - | - | - | - | - | - | - | |
| | | 3000 | - | - | - | - | - | - | - | - | - | - | - | |
| | | | Delayed R | 1000 | - | - | - | - | - | - | - | - | - | - |
| 3000 | - | | | - | - | - | - | - | - | - | - | - | | |

Selection guide

| Type | | Residual current circuit breakers | | | |
|--|--|---|---|--|---|
| | | iID K | iID | RCCB-ID 125 A | RCCB-ID type B |
| | |  |  |  |  |
| Standards | | IEC/EN 61008 | IEC/EN 61008 | IEC/EN 61008-1 and VDE 0664 | IEC/EN 61008 and VDE 0664 |
| Number of poles | 1P+N | – | – | – | – |
| | 2P | ■ | ■ | ■ | – |
| | 3P | – | – | – | – |
| | 4P | ■ | ■ | ■ | ■ |
| Type | AC | ■ | ■ | ■ | – |
| | A | – | ■ | ■ | – |
| | S/I | – | ■ | ■ | – |
| | B | – | – | – | ■ |
| Voltage (V) | Ue | 230/400 | 230/400 | 230/400 | 230/400 |
| Impulse voltage (kV) | Uimp | 4 | 6 | 4 | 4 |
| Insulation voltage (V) | Ui | 440 | 500 | 400 | 400 |
| Current rating (A) | In | 25 - 40 - 63 | 16 to 100 | 125 | 25 to 125 |
| Frequency (Hz) | | 50/60 | 50 | 50 | 50 |
| Rated breaking capacity (A) | Icn | – | – | – | – |
| Rated conditional short-circuit current | Icn | 4500 | 10000 | 10000 | 10000 |
| Rated residual breaking and making capacity (A) | (IΔm) | 10 In (500 A min.) | 1500 | 1250 | 10 In (500 A min.) |
| Sensitivity (mA) | (IΔn) 10 | – | ■ | – | – |
| | 30 | ■ | ■ | ■ | ■ |
| | 100 | – | ■ | ■ | – |
| | 300 | ■ | ■ | ■ | ■ |
| | 500 | – | ■ | ■ | ■ |
| | 1000 | – | – | – | – |
| | 3000 | – | – | – | – |
| | 300  | – | ■ | ■ | ■ |
| | 500  | – | ■ | – | – |
| | 1000  | – | – | – | – |
| 3000  | – | – | – | – | |
| Electrical characteristics | | | | | |
| Curves | B | – | – | – | – |
| | C | – | – | – | – |
| | D | – | – | – | – |
| | L | – | – | – | – |
| | K | – | – | – | – |
| | MA | – | – | – | – |
| | For more details, see module | | CA902007 | CA902002 | CM902001 |
| Accessories | | – | CA907000, CA907001 | CM902001 | CM902002 |
| Auxiliaries | | – | CA907000, CA907002 | CM902001 | CM902002 |

I_{nc}: rated conditional short-circuit current

Value of the alternating component of the prospective current that a residual current circuit breaker protected by an appropriate short-circuit protective device (SCPD) mounted in series can withstand in specified conditions of use.

I_{Δc}: rated residual short-circuit current

Value of the alternating component of the prospective residual current that a residual current circuit breaker protected by an appropriate short-circuit protective device (SCPD) mounted in series can withstand in specified conditions of use.

I_m: rated making and breaking capacity





Value of the alternating component of the prospective current that a residual current circuit breaker is capable of establishing or interrupting in specified conditions of use.

I_{Δm}: rated making and breaking capacity



Value of the alternating component of the prospective residual current that a residual current circuit breaker is capable of establishing and withstanding during its opening time and interrupting in specified conditions of use and behaviour.

SCPD

Short-circuit protective device (a fuse in the case of our markings): this is the max. fuse that can be used to resist the value $I_{nc} = I_{Δc}$.

| Add-on residual current devices | | | Residual current devices RCBO | | |
|---|---|--|---|---|--|
| Vigi iC60 | | | Vigi C120 | | |
| Vigi NG125 | | | DPNa Vigi | | |
| DPN N Vigi | | | | | |
|  |  |  |  |  | |
| IEC/EN 61009 | IEC/EN 61009 | IEC/EN 61009 | IEC/EN 61009 | IEC/EN 61009 | |
| - | - | - | ■ | ■ | |
| ■ | ■ | ■ | - | - | |
| ■ | ■ | ■ | - | - | |
| ■ | ■ | ■ | ■ | ■ | |
| ■ | ■ | ■ | - | - | |
| ■ | ■ | ■ | ■ | ■ | |
| - | - | - | - | - | |
| 230/400 | 230/400 | 230/400 | 230 | 230 | |
| 6 | 6 | 8 | 4 | 4 | |
| 500 | 500 | 690 | 400 | 400 | |
| 25 - 40 - 63 | 10 - 125 | 63 - 125 | 10 - 16 | 4 to 40 | |
| 50/60 | 50/60 | 50/60 | 50/60 | 50/60 | |
| - | - | - | 4500 | 6000 | |
| - | - | - | - | - | |
| - | - | - | 4500 | 6000 | |
| ■ | - | - | ■ | - | |
| ■ | ■ | ■ | - | ■ | |
| ■ | - | - | - | - | |
| ■ | ■ | ■ | - | ■ | |
| ■ | ■ | ■ | - | - | |
| - | - | ■ | - | - | |
| - | - | ■ | - | - | |
| ■ | ■ | ■ | - | - | |
| ■ | ■ | ■ | - | - | |
| - | - | ■ | - | - | |
| Depending on circuit breaker used | Depending on circuit breaker used | Depending on circuit breaker used | - | ■ | |
| | | | ■ | ■ | |
| | | | - | - | |
| | | | - | - | |
| | | | - | - | |
| | | | - | - | |
| | | | - | - | |
| CA902005 | CA902016 | CM902008 | CA902014 | CA902014 | |
| CA907000, CA907001 | CA907012, CA907013 | CM907004, CM907006 | CA907013, CA907012 | CA907013, CA907012 | |
| CA907000, CA907002 | CA907008, CA907013 | CM907004, CM907005 | CA907013, CA907008 | CA907013, CA907008 | |

Selection guide

| Type | | Residual current circuit breakers | Add-on residual current devices |
|--|----------------|---|---|
| | | xID | Vigi xC60 |
| | |  |  |
| | | IEC/EN 61008 | IEC/EN 61009 |
| Standards | | | |
| Number of poles | 1P+N | – | – |
| | 2P | ■ | ■ |
| | 3P | – | – |
| | 4P | ■ | ■ |
| Type | AC | ■ | ■ |
| | A | – | – |
| | S/I | ■ | – |
| | B | – | – |
| Voltage (V) | Ue | 230/400 | 230/400 |
| Impulse voltage (kV) | Uimp | 6 | 6 |
| Insulation voltage (V) | Ui | 440 | 500 |
| Current rating (A) | In | 25 - 40 - 63 - 80 | 25 - 63 |
| Frequency (Hz) | | 50/60 | 50/60 |
| Rated breaking capacity (A) | Icn | – | – |
| Rated conditional short-circuit current | Icn | 10,000 | – |
| Rated residual breaking and making capacity (A) | (Δm) | 10 In (500 A min.) | – |
| Curve | | – | – |
| Sensitivity (mA) | (Δn) | – | – |
| | 10 | – | – |
| | 30 | ■ | ■ |
| | 100 | ■ | ■ |
| | 300 | ■ | ■ |
| | 500 | – | – |
| | 1000 | – | – |
| | 3000 | – | – |
| | 300 \square | ■ | – |
| | 500 \square | – | – |
| | 1000 \square | – | – |
| | 3000 \square | – | – |
| Electrical characteristics | | | |
| Curves | B | – | Depending on circuit breaker used |
| | C | – | |
| | D | – | |
| | L | – | |
| | K | – | |
| | MA | – | |
| For more details, see module | | CA902028 | CA902029 |
| Accessories | | CA907012 | CA907012 |
| Auxiliaries | | CA907008 | CA907008 |

Schneider Electric's range of residual current circuit breakers consists of different products (A, B, C, D) to enable it to be the most competitive range possible in each country, allowing for the special characteristics of each market:

- usual installation procedure
- price
- accreditations by local bodies.

Variants

| Offers | | Pages |
|--------------|-------------------|-------|
| Offer A | Catalogue numbers | 146 |
| Offer B | Catalogue numbers | 149 |
| Offer C | Catalogue numbers | 152 |
| Offer D | Catalogue numbers | 155 |
| Common pages | | 158 |

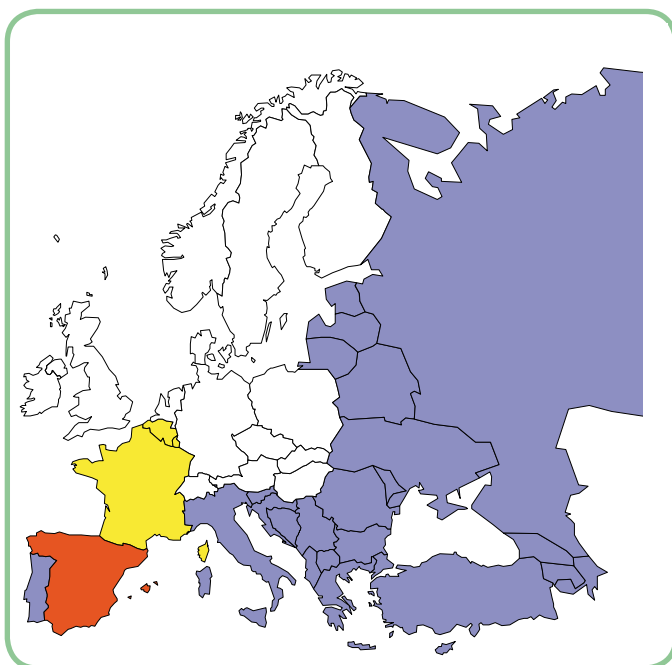

Only the product range to be marketed in your country and validated by the local product manager, in agreement with his Final Distribution (FD) partner should be retained. The others will be removed before publication.

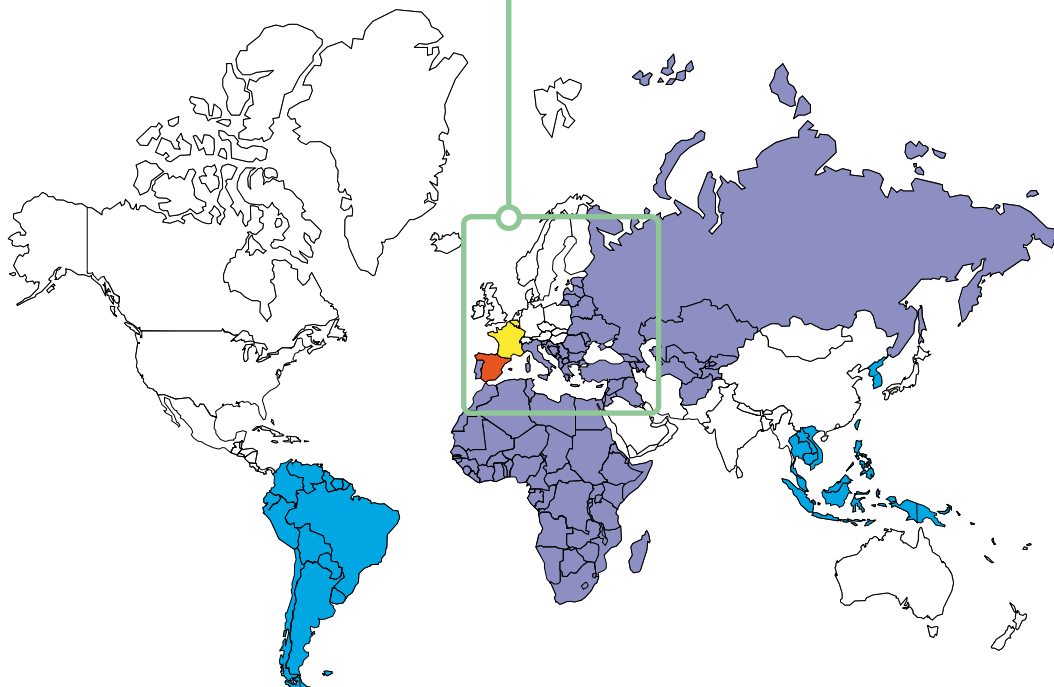

IEC/EN 61008-1

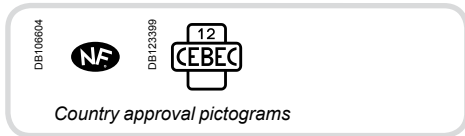

DB104472-40



- The iID residual current circuit breakers provide:
 - protection of persons against electric shock by direct contact (≤ 30 mA),
 - protection of persons against electric shock by indirect contact (≥ 100 mA),
 - protection of installations against the risk of fire (300 mA or 500 mA).

Catalogue numbers

| iID residual current circuit breakers | | | | | | | | |
|---------------------------------------|---|-------------|----------|----------|----------|----------|--|--|
| Type | AC <input checked="" type="checkbox"/> <input type="checkbox"/> | | | | | | | |
| Product | iID | | | | | | | |
| Auxiliaries | Can accept auxiliaries, module CA907002 | | | | | | | |
| 2P | Sensitivity | 10 mA | 30 mA | 100 mA | 300 mA | 500 mA | 300 mA <input checked="" type="checkbox"/> | 500 mA <input checked="" type="checkbox"/> |
| | Rating | 16 A | A9R10216 | - | - | - | - | - |
| | | 25 A | A9R10225 | A9R11225 | - | A9R14225 | A9R16225 | - |
| | | 40 A | - | A9R11240 | A9R12240 | A9R14240 | A9R16240 | - |
| | | 63 A | - | A9R11263 | A9R12263 | A9R14263 | A9R16263 | A9R15263 |
| | | 80 A | - | A9R11280 | A9R12280 | A9R14280 | - | A9R15280 |
| | | 100 A | - | A9R11291 | A9R12291 | A9R14291 | - | A9R15291 |
| | Rating | 25 A | - | A9R11425 | - | A9R14425 | A9R16425 | - |
| | | 40 A | - | A9R11440 | A9R12440 | A9R14440 | A9R16440 | A9R15440 |
| | | 63 A | - | A9R11463 | A9R12463 | A9R14463 | A9R16463 | A9R15463 |
| | | 80 A | - | A9R11480 | A9R12480 | A9R14480 | A9R16480 | A9R15480 |
| | | 100 A | - | A9R11491 | A9R12491 | A9R14491 | - | A9R15491 |
| | | | | | | | | |
| Voltage rating (Ue) | 2P | 230 - 240 V | | | | | | |
| | 4P | 400 - 415 V | | | | | | |
| Operating frequency | 50/60 Hz | | | | | | | |
| Accessories | Module CA907000 and CA907001 | | | | | | | |

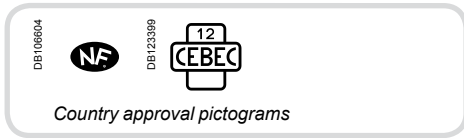

IEC/EN 61008-1



- The iID residual current circuit breakers provide:
 - protection of persons against electric shock by direct contact (≤ 30 mA),
 - protection of persons against electric shock by indirect contact (≥ 100 mA),
 - protection of installations against the risk of fire (300 mA or 500 mA).

Catalogue numbers

| iID residual current circuit breakers | | | | | | | | | |
|---------------------------------------|---|-------------|----------|----------|----------|----------|----------|----------------------|----------|
| Type | A | | | | | | | Width in 9 mm module | |
| Product | iID | | | | | | | | |
| Auxiliaries | Can accept auxiliaries, module CA907002 | | | | | | | | |
| | Sensitivity | 10 mA | 30 mA | 100 mA | 300 mA | 500 mA | 300 mA | | |
| DB122476 | Rating | 16 A | A9R20216 | - | - | - | - | 4 | |
| | | 25 A | A9R20225 | A9R01225 | - | A9R04225 | - | | |
| | | 40 A | - | A9R01240 | - | A9R04240 | - | | A9R05240 |
| | | 63 A | - | A9R01263 | - | A9R04263 | - | | A9R05263 |
| | | 100 A | - | A9R01291 | - | A9R04291 | - | | A9R05291 |
| DB122477 | Rating | 25 A | - | A9R01425 | - | A9R04425 | - | 8 | |
| | | 40 A | - | A9R01440 | A9R22440 | A9R04440 | A9R26440 | | A9R05440 |
| | | 63 A | - | A9R01463 | A9R22463 | A9R04463 | A9R26463 | | A9R05463 |
| | | 80 A | - | A9R21480 | - | A9R24480 | - | | A9R25480 |
| | | 100 A | - | A9R01491 | - | A9R04491 | A9R26491 | | A9R05491 |
| Voltage rating (U _e) | 2P | 230 - 240 V | | | | | | | |
| | 4P | 400 - 415 V | | | | | | | |
| Operating frequency | 50/60 Hz | | | | | | | | |
| Accessories | Module CA907000 and CA907001 | | | | | | | | |

IEC/EN 61008-1

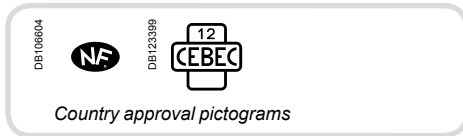

PB104472-40



Offer selection see page 145

offer A

- The iID residual current circuit breakers provide:
 - protection of persons against electric shock by direct contact (≤ 30 mA),
 - protection of persons against electric shock by indirect contact (≥ 300 mA),
 - protection of installations against the risk of fire (300 mA or 500 mA).

The SI type provides increased immunity from electrical interference and polluted or corrosive environments.

This sticker must be removed before publishing

Catalogue numbers

| iID residual current circuit breakers | | | | | | | |
|---------------------------------------|---|-------------|-----------------|-----------------|-----------------|-----------------|----------------------|
| Type | SI | | | | | | Width in 9 mm module |
| Product | iID | | | | | | |
| Auxiliaries | Can accept auxiliaries, module CA907002 | | | | | | |
| | Sensitivity | 10 mA | 30 mA | 300 mA | 300 mA | 500 mA | |
| DB122476 | Rating | 16 A | - | - | - | - | 4 |
| | | 25 A | A9R30225 | A9R31225 | - | - | |
| | | 40 A | - | A9R31240 | - | A9R35240 | |
| | | 63 A | - | A9R31263 | - | A9R35263 | |
| | | 100 A | - | - | - | A9R35291 | |
| DB122477 | Rating | 25 A | - | A9R31425 | - | - | 8 |
| | | 40 A | - | A9R31440 | - | A9R35440 | |
| | | 63 A | - | A9R31463 | A9R34463 | A9R35463 | |
| | | 80 A | - | A9R31480 | - | A9R35480 | |
| | | 100 A | - | A9R31491 | A9R34491 | A9R35491 | |
| Voltage rating (Ue) | 2P | 230 - 240 V | | | | | |
| | 4P | 400 - 415 V | | | | | |
| Operating frequency | 50/60 Hz | | | | | | |
| Accessories | Module CA907000 and CA907001 | | | | | | |

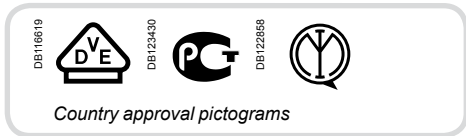

IEC/EN 61008-1



- The iID residual current circuit breakers provide:
 - protection of persons against electric shock by direct contact (≤ 30 mA),
 - protection of persons against electric shock by indirect contact (≥ 100 mA),
 - protection of installations against the risk of fire (300 mA or 500 mA).

Catalogue numbers

| iID residual current circuit breakers | | | | | | | | | | |
|---------------------------------------|---|-------------|----------|----------|----------|----------|----------|----------|--------|----------------------|
| Type | AC | | | | | | | | | |
| Product | iID | | | | | | | | | |
| Auxiliaries | Can accept auxiliaries, module CA907002 | | | | | | | | | |
| | | Sensitivity | 10 mA | 30 mA | 100 mA | 300 mA | 500 mA | 300 mA | 500 mA | Width in 9 mm module |
| | Rating | 16 A | A9R10216 | - | - | - | - | - | - | 4 |
| | | 25 A | A9R10225 | A9R41225 | - | A9R44225 | A9R16225 | - | - | |
| | | 40 A | - | A9R41240 | A9R12240 | A9R44240 | A9R16240 | - | - | |
| | | 63 A | - | A9R41263 | A9R12263 | A9R44263 | A9R16263 | A9R15263 | - | |
| | | 80 A | - | A9R11280 | A9R12280 | A9R14280 | - | A9R15280 | - | |
| | | 100 A | - | A9R11291 | A9R12291 | A9R14291 | - | A9R15291 | - | |
| | Rating | 25 A | A9R41425 | - | A9R44425 | A9R16425 | - | - | 8 | |
| | | 40 A | - | A9R41440 | A9R12440 | A9R44440 | A9R16440 | A9R15440 | | A9R17440 |
| | | 63 A | - | A9R41463 | A9R12463 | A9R44463 | A9R16463 | A9R15463 | | A9R17463 |
| | | 80 A | - | A9R11480 | A9R12480 | A9R14480 | A9R16480 | A9R15480 | | A9R17480 |
| | | 100 A | - | A9R11491 | A9R12491 | A9R14491 | - | A9R15491 | | - |
| Voltage rating (Ue) | 2P | 230 - 240 V | | | | | | | | |
| | 4P | 400 - 415 V | | | | | | | | |
| Operating frequency | 50/60 Hz | | | | | | | | | |
| Accessories | Module CA907000 and CA907001 | | | | | | | | | |

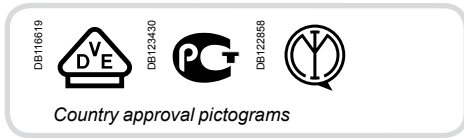

IEC/EN 61008-1

PB104472-40



- The iID residual current circuit breakers provide:
 - protection of persons against electric shock by direct contact (≤ 30 mA),
 - protection of persons against electric shock by indirect contact (≥ 100 mA),
 - protection of installations against the risk of fire (300 mA or 500 mA).

Catalogue numbers

| iID residual current circuit breakers | | | | | | | | | |
|---------------------------------------|---|-------------|----------|----------|----------|----------|----------|----------------------|--|
| Type | A | | | | | | | Width in 9 mm module | |
| Product | iID | | | | | | | | |
| Auxiliaries | Can accept auxiliaries, module CA907002 | | | | | | | | |
| | Sensitivity | 10 mA | 30 mA | 100 mA | 300 mA | 500 mA | 300 mA | | |
| DB122476 | Rating | 16 A | - | - | - | - | - | 4 | |
| | | 25 A | A9R20216 | - | - | - | - | | |
| | | 40 A | A9R20225 | A9R21225 | - | A9R24225 | - | | |
| | | 63 A | - | A9R21240 | - | A9R24240 | - | | |
| | | 100 A | - | A9R21263 | - | A9R24263 | - | | |
| DB122477 | Rating | 25 A | A9R21425 | - | A9R24425 | - | - | 8 | |
| | | 40 A | A9R21440 | A9R22440 | A9R24440 | A9R26440 | A9R25440 | | |
| | | 63 A | A9R21463 | A9R22463 | A9R24463 | A9R26463 | A9R25463 | | |
| | | 80 A | A9R21480 | - | A9R24480 | - | A9R25480 | | |
| | | 100 A | A9R21491 | - | A9R24491 | A9R26491 | A9R25491 | | |
| Voltage rating (Ue) | 2P | 230 - 240 V | | | | | | | |
| | 4P | 400 - 415 V | | | | | | | |
| Operating frequency | 50/60 Hz | | | | | | | | |
| Accessories | Module CA907000 and CA907001 | | | | | | | | |

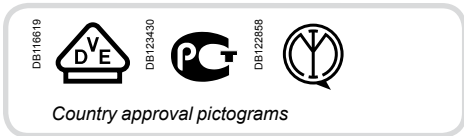

IEC/EN 61008-1

Offer selection see page 145

■ The iID residual current circuit breakers provide:

- protection of persons against electric shock by direct contact (≤ 30 mA),
- protection of persons against electric shock by indirect contact (≥ 300 mA),
- protection of installations against the risk of fire (300 mA or 500 mA).

The SI type provides increased immunity from electrical interference and polluted or corrosive environments.

offer B

This sticker must be removed before publishing

Catalogue numbers

| iID residual current circuit breakers | | | | | | | |
|---------------------------------------|---|-------------|----------|----------|----------|----------|----------------------|
| Type | SI | | | | | | Width in 9 mm module |
| Product | iID | | | | | | |
| Auxiliaries | Can accept auxiliaries, module CA907002 | | | | | | |
| | Sensitivity | 10 mA | 30 mA | 300 mA | 300 mA | 500 mA | |
| <p>DB12476</p> | Rating | 16 A | - | - | - | - | 4 |
| | | 25 A | A9R30225 | A9R61225 | - | - | |
| | | 40 A | - | A9R61240 | - | A9R35240 | |
| | | 63 A | - | A9R61263 | - | A9R35263 | |
| | | 100 A | - | - | - | A9R35291 | |
| <p>DB12477</p> | Rating | 25 A | - | A9R61425 | - | - | 8 |
| | | 40 A | - | A9R61440 | - | A9R35440 | |
| | | 63 A | - | A9R61463 | A9R34463 | A9R35463 | |
| | | 80 A | - | A9R31480 | - | A9R35480 | |
| | | 100 A | - | A9R31491 | A9R34491 | A9R35491 | |
| Voltage rating (Ue) | 2P | 230 - 240 V | | | | | |
| | 4P | 400 - 415 V | | | | | |
| Operating frequency | 50/60 Hz | | | | | | |
| Accessories | Module CA907000 and CA907001 | | | | | | |



Country approval pictograms

IEC/EN 61008-1

PB104472-40

PB104473-40



- The iID residual current circuit breakers provide:
 - protection of persons against electric shock by direct contact (≤ 30 mA),
 - protection of persons against electric shock by indirect contact (≥ 100 mA),
 - protection of installations against the risk of fire (300 mA or 500 mA).

Catalogue numbers

iID residual current circuit breakers

| Type | AC | Width in 9 mm module | | | | | | | | | | | | | | | | | | | | | | | | | | | | | | | | | | | | | | | | | | | | | | | | | | | | | | | | |
|---------------------|---|----------------------|----------|----------|----------|----------|----------|--------|--------|-------------|----------|----------|---|----------|----------|---|---|------|----------|----------|----------|----------|----------|----------|----------|------|---|----------|----------|----------|----------|----------|----------|------|---|----------|----------|----------|----------|----------|----------|-------|---|----------|----------|----------|---|----------|---|-------|---|----------|----------|----------|---|----------|---|---|
| Product | iID | | | | | | | | | | | | | | | | | | | | | | | | | | | | | | | | | | | | | | | | | | | | | | | | | | | | | | | | | |
| Auxiliaries | Can accept auxiliaries, module CA907002 | | | | | | | | | | | | | | | | | | | | | | | | | | | | | | | | | | | | | | | | | | | | | | | | | | | | | | | | | |
| 2P | <table border="1"> <thead> <tr> <th>Sensitivity</th> <th>10 mA</th> <th>30 mA</th> <th>100 mA</th> <th>300 mA</th> <th>500 mA</th> <th>300 mA </th> <th>500 mA </th> </tr> </thead> <tbody> <tr> <td>Rating 16 A</td> <td>A9R10216</td> <td>-</td> <td>-</td> <td>-</td> <td>-</td> <td>-</td> <td>-</td> </tr> <tr> <td>25 A</td> <td>A9R10225</td> <td>A9R71225</td> <td>-</td> <td>A9R74225</td> <td>A9R16225</td> <td>-</td> <td>-</td> </tr> <tr> <td>40 A</td> <td>-</td> <td>A9R71240</td> <td>A9R12240</td> <td>A9R74240</td> <td>A9R16240</td> <td>-</td> <td>-</td> </tr> <tr> <td>63 A</td> <td>-</td> <td>A9R71263</td> <td>A9R12263</td> <td>A9R74263</td> <td>A9R16263</td> <td>A9R15263</td> <td>-</td> </tr> <tr> <td>80 A</td> <td>-</td> <td>A9R11280</td> <td>A9R12280</td> <td>A9R14280</td> <td>-</td> <td>A9R15280</td> <td>-</td> </tr> <tr> <td>100 A</td> <td>-</td> <td>A9R11291</td> <td>A9R12291</td> <td>A9R14291</td> <td>-</td> <td>A9R15291</td> <td>-</td> </tr> </tbody> </table> | Sensitivity | 10 mA | 30 mA | 100 mA | 300 mA | 500 mA | 300 mA | 500 mA | Rating 16 A | A9R10216 | - | - | - | - | - | - | 25 A | A9R10225 | A9R71225 | - | A9R74225 | A9R16225 | - | - | 40 A | - | A9R71240 | A9R12240 | A9R74240 | A9R16240 | - | - | 63 A | - | A9R71263 | A9R12263 | A9R74263 | A9R16263 | A9R15263 | - | 80 A | - | A9R11280 | A9R12280 | A9R14280 | - | A9R15280 | - | 100 A | - | A9R11291 | A9R12291 | A9R14291 | - | A9R15291 | - | 4 |
| Sensitivity | 10 mA | 30 mA | 100 mA | 300 mA | 500 mA | 300 mA | 500 mA | | | | | | | | | | | | | | | | | | | | | | | | | | | | | | | | | | | | | | | | | | | | | | | | | | | |
| Rating 16 A | A9R10216 | - | - | - | - | - | - | | | | | | | | | | | | | | | | | | | | | | | | | | | | | | | | | | | | | | | | | | | | | | | | | | | |
| 25 A | A9R10225 | A9R71225 | - | A9R74225 | A9R16225 | - | - | | | | | | | | | | | | | | | | | | | | | | | | | | | | | | | | | | | | | | | | | | | | | | | | | | | |
| 40 A | - | A9R71240 | A9R12240 | A9R74240 | A9R16240 | - | - | | | | | | | | | | | | | | | | | | | | | | | | | | | | | | | | | | | | | | | | | | | | | | | | | | | |
| 63 A | - | A9R71263 | A9R12263 | A9R74263 | A9R16263 | A9R15263 | - | | | | | | | | | | | | | | | | | | | | | | | | | | | | | | | | | | | | | | | | | | | | | | | | | | | |
| 80 A | - | A9R11280 | A9R12280 | A9R14280 | - | A9R15280 | - | | | | | | | | | | | | | | | | | | | | | | | | | | | | | | | | | | | | | | | | | | | | | | | | | | | |
| 100 A | - | A9R11291 | A9R12291 | A9R14291 | - | A9R15291 | - | | | | | | | | | | | | | | | | | | | | | | | | | | | | | | | | | | | | | | | | | | | | | | | | | | | |
| 4P | <table border="1"> <thead> <tr> <th>Sensitivity</th> <th>10 mA</th> <th>30 mA</th> <th>100 mA</th> <th>300 mA</th> <th>500 mA</th> <th>300 mA </th> <th>500 mA </th> </tr> </thead> <tbody> <tr> <td>Rating 25 A</td> <td>-</td> <td>A9R71425</td> <td>-</td> <td>A9R74425</td> <td>A9R16425</td> <td>-</td> <td>-</td> </tr> <tr> <td>40 A</td> <td>-</td> <td>A9R71440</td> <td>A9R12440</td> <td>A9R74440</td> <td>A9R16440</td> <td>A9R15440</td> <td>A9R17440</td> </tr> <tr> <td>63 A</td> <td>-</td> <td>A9R71463</td> <td>A9R12463</td> <td>A9R74463</td> <td>A9R16463</td> <td>A9R15463</td> <td>A9R17463</td> </tr> <tr> <td>80 A</td> <td>-</td> <td>A9R11480</td> <td>A9R12480</td> <td>A9R14480</td> <td>A9R16480</td> <td>A9R15480</td> <td>A9R17480</td> </tr> <tr> <td>100 A</td> <td>-</td> <td>A9R11491</td> <td>A9R12491</td> <td>A9R14491</td> <td>-</td> <td>A9R15491</td> <td>-</td> </tr> </tbody> </table> | Sensitivity | 10 mA | 30 mA | 100 mA | 300 mA | 500 mA | 300 mA | 500 mA | Rating 25 A | - | A9R71425 | - | A9R74425 | A9R16425 | - | - | 40 A | - | A9R71440 | A9R12440 | A9R74440 | A9R16440 | A9R15440 | A9R17440 | 63 A | - | A9R71463 | A9R12463 | A9R74463 | A9R16463 | A9R15463 | A9R17463 | 80 A | - | A9R11480 | A9R12480 | A9R14480 | A9R16480 | A9R15480 | A9R17480 | 100 A | - | A9R11491 | A9R12491 | A9R14491 | - | A9R15491 | - | 8 | | | | | | | | |
| Sensitivity | 10 mA | 30 mA | 100 mA | 300 mA | 500 mA | 300 mA | 500 mA | | | | | | | | | | | | | | | | | | | | | | | | | | | | | | | | | | | | | | | | | | | | | | | | | | | |
| Rating 25 A | - | A9R71425 | - | A9R74425 | A9R16425 | - | - | | | | | | | | | | | | | | | | | | | | | | | | | | | | | | | | | | | | | | | | | | | | | | | | | | | |
| 40 A | - | A9R71440 | A9R12440 | A9R74440 | A9R16440 | A9R15440 | A9R17440 | | | | | | | | | | | | | | | | | | | | | | | | | | | | | | | | | | | | | | | | | | | | | | | | | | | |
| 63 A | - | A9R71463 | A9R12463 | A9R74463 | A9R16463 | A9R15463 | A9R17463 | | | | | | | | | | | | | | | | | | | | | | | | | | | | | | | | | | | | | | | | | | | | | | | | | | | |
| 80 A | - | A9R11480 | A9R12480 | A9R14480 | A9R16480 | A9R15480 | A9R17480 | | | | | | | | | | | | | | | | | | | | | | | | | | | | | | | | | | | | | | | | | | | | | | | | | | | |
| 100 A | - | A9R11491 | A9R12491 | A9R14491 | - | A9R15491 | - | | | | | | | | | | | | | | | | | | | | | | | | | | | | | | | | | | | | | | | | | | | | | | | | | | | |
| Voltage rating (Ue) | 2P | 230 - 240 V | | | | | | | | | | | | | | | | | | | | | | | | | | | | | | | | | | | | | | | | | | | | | | | | | | | | | | | | |
| | 4P | 400 - 415 V | | | | | | | | | | | | | | | | | | | | | | | | | | | | | | | | | | | | | | | | | | | | | | | | | | | | | | | | |
| Operating frequency | | 50/60 Hz | | | | | | | | | | | | | | | | | | | | | | | | | | | | | | | | | | | | | | | | | | | | | | | | | | | | | | | | |
| Accessories | Module CA907000 and CA907001 | | | | | | | | | | | | | | | | | | | | | | | | | | | | | | | | | | | | | | | | | | | | | | | | | | | | | | | | | |

DB12476

DB12477

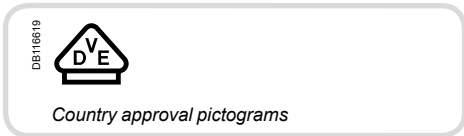

IEC/EN 61008-1



- The iID residual current circuit breakers provide:
 - protection of persons against electric shock by direct contact (≤ 30 mA),
 - protection of persons against electric shock by indirect contact (≥ 100 mA),
 - protection of installations against the risk of fire (300 mA or 500 mA).

Catalogue numbers

| iID residual current circuit breakers | | | | | | | | | |
|---------------------------------------|---|-------------|----------|----------|----------|----------|----------|----------------------|--|
| Type | A | | | | | | | Width in 9 mm module | |
| Product | iID | | | | | | | | |
| Auxiliaries | Can accept auxiliaries, module CA907002 | | | | | | | | |
| | Sensitivity | 10 mA | 30 mA | 100 mA | 300 mA | 500 mA | 300 mA | | |
| DB12476 | Rating | 16 A | - | - | - | - | - | 4 | |
| | | 25 A | A9R20216 | A9R51225 | - | A9R54225 | - | | |
| | | 40 A | - | A9R51240 | - | A9R54240 | - | A9R25240 | |
| | | 63 A | - | A9R51263 | - | A9R54263 | - | A9R25263 | |
| | | 100 A | - | A9R21291 | - | A9R24291 | - | A9R25291 | |
| DB12477 | Rating | 25 A | - | A9R51425 | - | A9R54425 | - | 8 | |
| | | 40 A | - | A9R51440 | A9R22440 | A9R54440 | A9R26440 | A9R25440 | |
| | | 63 A | - | A9R51463 | A9R22463 | A9R54463 | A9R26463 | A9R25463 | |
| | | 80 A | - | A9R21480 | - | A9R24480 | - | A9R25480 | |
| | | 100 A | - | A9R21491 | - | A9R24491 | A9R26491 | A9R25491 | |
| Voltage rating (Ue) | 2P | 230 - 240 V | | | | | | | |
| | 4P | 400 - 415 V | | | | | | | |
| Operating frequency | 50/60 Hz | | | | | | | | |
| Accessories | Module CA907000 and CA907001 | | | | | | | | |

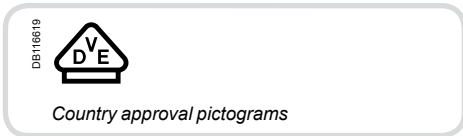

IEC/EN 61008-1

PB104472-40



- The iID residual current circuit breakers provide:
 - protection of persons against electric shock by direct contact (≤ 30 mA),
 - protection of persons against electric shock by indirect contact (≥ 300 mA),
 - protection of installations against the risk of fire (300 mA or 500 mA).

The SI type provides increased immunity from electrical interference and polluted or corrosive environments.

Catalogue numbers

| iID residual current circuit breakers | | | | | | | |
|---------------------------------------|---|-------------|----------|----------|----------|----------|----------------------|
| Type | SI | | | | | | Width in 9 mm module |
| Product | iID | | | | | | |
| Auxiliaries | Can accept auxiliaries, module CA907002 | | | | | | |
| | Sensitivity | 10 mA | 30 mA | 300 mA | 300 mA | 500 mA | |
| DB12476 | Rating | 16 A | - | - | - | - | 4 |
| | | 25 A | A9R30225 | A9R91225 | - | - | |
| | | 40 A | - | A9R91240 | - | A9R35240 | |
| | | 63 A | - | A9R91263 | - | A9R35263 | |
| | | 100 A | - | - | - | A9R35291 | |
| DB12477 | Rating | 25 A | - | A9R91425 | - | - | 8 |
| | | 40 A | - | A9R91440 | - | A9R35440 | |
| | | 63 A | - | A9R91463 | A9R34463 | A9R35463 | |
| | | 80 A | - | A9R31480 | - | A9R35480 | |
| | | 100 A | - | A9R31491 | A9R34491 | A9R35491 | |
| Voltage rating (Ue) | 2P | 230 - 240 V | | | | | |
| | 4P | 400 - 415 V | | | | | |
| Operating frequency | 50/60 Hz | | | | | | |
| Accessories | Module CA907000 and CA907001 | | | | | | |

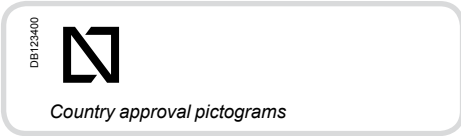

IEC/EN 61008-1

PB10472-40

Offer selection see page 145

- The iID residual current circuit breakers provide:
 - protection of persons against electric shock by direct contact (≤ 30 mA),
 - protection of persons against electric shock by indirect contact (≥ 100 mA),
 - protection of installations against the risk of fire (300 mA or 500 mA).

Offer D

This sticker must be removed before publishing

Catalogue numbers

iID residual current circuit breakers

| iID residual current circuit breakers | | | | | | | | | | |
|---------------------------------------|---|---------------------|----------|-------------|----------|----------|----------|----------|----------|----------------------|
| Type | AC | | | | | | | | | Width in 9 mm module |
| Product | iID | | | | | | | | | |
| Auxiliaries | Can accept auxiliaries, module CA907002 | | | | | | | | | |
| | | Sensitivity | 10 mA | 30 mA | 100 mA | 300 mA | 500 mA | 300 mA | 500 mA | |
| <p>DB12476</p> | Rating | 16 A | A9R10216 | - | - | - | - | - | - | 4 |
| | | 25 A | A9R10225 | A9R81225 | - | A9R84225 | A9R16225 | - | - | |
| | | 40 A | - | A9R81240 | A9R12240 | A9R84240 | A9R16240 | - | - | |
| | | 63 A | - | A9R81263 | A9R12263 | A9R84263 | A9R16263 | A9R15263 | - | |
| | | 80 A | - | A9R11280 | A9R12280 | A9R14280 | - | A9R15280 | - | |
| | | 100 A | - | A9R11291 | A9R12291 | A9R14291 | - | A9R15291 | - | |
| <p>DB12477</p> | Rating | 25 A | - | A9R81425 | - | A9R84425 | A9R16425 | - | - | 8 |
| | | 40 A | - | A9R81440 | A9R12440 | A9R84440 | A9R16440 | A9R15440 | A9R17440 | |
| | | 63 A | - | A9R81463 | A9R12463 | A9R84463 | A9R16463 | A9R15463 | A9R17463 | |
| | | 80 A | - | A9R11480 | A9R12480 | A9R14480 | A9R16480 | A9R15480 | A9R17480 | |
| | | 100 A | - | A9R11491 | A9R12491 | A9R14491 | - | A9R15491 | - | |
| | | Voltage rating (Ue) | 2P | 230 - 240 V | | | | | | |
| | 4P | 400 - 415 V | | | | | | | | |
| Operating frequency | 50/60 Hz | | | | | | | | | |
| Accessories | Module CA907000 and CA907001 | | | | | | | | | |

IEC/EN 61008-1

DB123400



Country approval pictograms

PB104472-40

PB104473-40

Offer selection see page 145



offer D

This sticker must be removed before publishing

- The iID residual current circuit breakers provide:
 - protection of persons against electric shock by direct contact (≤ 30 mA),
 - protection of persons against electric shock by indirect contact (≥ 100 mA),
 - protection of installations against the risk of fire (300 mA or 500 mA).

Catalogue numbers

iID residual current circuit breakers

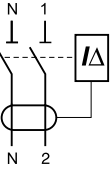
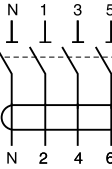
| Type | A  | | | | | | | Width in 9 mm module | |
|---|---|-------------|----------|----------|----------|----------|--|----------------------|----------|
| Product | iID | | | | | | | | |
| Auxiliaries | Can accept auxiliaries, module CA907002 | | | | | | | | |
| 2P | Sensitivity | 10 mA | 30 mA | 100 mA | 300 mA | 500 mA | 300 mA  | | |
|  | Rating | 16 A | A9R20216 | - | - | - | - | 4 | |
| | | 25 A | A9R20225 | A9R21225 | - | A9R24225 | - | | |
| | | 40 A | - | A9R21240 | - | A9R24240 | - | | A9R25240 |
| | | 63 A | - | A9R21263 | - | A9R24263 | - | | A9R25263 |
| | | 100 A | - | A9R21291 | - | A9R24291 | - | | A9R25291 |
|  | Rating | 25 A | - | A9R21425 | - | A9R24425 | - | 8 | |
| | | 40 A | - | A9R21440 | A9R22440 | A9R24440 | A9R26440 | | A9R25440 |
| | | 63 A | - | A9R21463 | A9R22463 | A9R24463 | A9R26463 | | A9R25463 |
| | | 80 A | - | A9R21480 | - | A9R24480 | - | | A9R25480 |
| | | 100 A | - | A9R21491 | - | A9R24491 | A9R26491 | | A9R25491 |
| Voltage rating (Ue) | 2P | 230 - 240 V | | | | | | | |
| | 4P | 400 - 415 V | | | | | | | |
| Operating frequency | 50/60 Hz | | | | | | | | |
| Accessories | Module CA907000 and CA907001 | | | | | | | | |

DB123400



Country approval pictograms

IEC/EN 61008-1

PB104472-40

Offer selection see page 145

- The iID residual current circuit breakers provide:
 - protection of persons against electric shock by direct contact (≤ 30 mA),
 - protection of persons against electric shock by indirect contact (≥ 300 mA),
 - protection of installations against the risk of fire (300 mA or 500 mA).

The SI type provides increased immunity from electrical interference and polluted or corrosive environments.

This sticker must be removed before publishing

Catalogue numbers

iID residual current circuit breakers

| Type | SI | | | | | | Width in 9 mm module |
|---------------------|---|-------------|-----------------|-----------------|-----------------|-----------------|----------------------|
| Product | iID | | | | | | |
| Auxiliaries | Can accept auxiliaries, module CA907002 | | | | | | |
| 2P | Sensitivity | 10 mA | 30 mA | 300 mA | 300 mA | 500 mA | |
| | Rating | 16 A | - | - | - | - | 4 |
| | | 25 A | A9R30225 | A9R61225 | - | - | |
| | | 40 A | - | A9R61240 | - | A9R35240 | |
| | | 63 A | - | A9R61263 | - | A9R35263 | |
| | | 100 A | - | - | - | A9R35291 | |
| 4P | Sensitivity | 10 mA | 30 mA | 300 mA | 300 mA | 500 mA | |
| | Rating | 25 A | - | A9R61425 | - | - | 8 |
| | | 40 A | - | A9R61440 | - | A9R35440 | A9R37440 |
| | | 63 A | - | A9R61463 | A9R34463 | A9R35463 | A9R37463 |
| | | 80 A | - | A9R31480 | - | A9R35480 | A9R37480 |
| | | 100 A | - | A9R31491 | A9R34491 | A9R35491 | - |
| Voltage rating (Ue) | 2P | 230 - 240 V | | | | | |
| | 4P | 400 - 415 V | | | | | |
| Operating frequency | 50/60 Hz | | | | | | |
| Accessories | Module CA907000 and CA907001 | | | | | | |

Connection

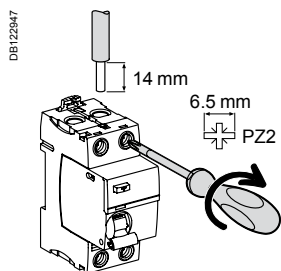

| Type | Tightening torque | Without accessory | | With accessories* | | | |
|------|-------------------|-------------------------|-------------------------|--------------------|---------------------------------------|------------------------|------------------------|
| | | Copper cables | | 50 mm ² | Screw-on connection for ring terminal | Multi-cables terminal | |
| | | Rigid | Flexible or ferrule | Al terminal | | Rigid cables | Flexible cables |
| iID | 3.5 N.m | 1 to 35 mm ² | 1 to 25 mm ² | 50 mm ² | Ø 5 mm | 3 x 16 mm ² | 3 x 10 mm ² |

* See module CA907000

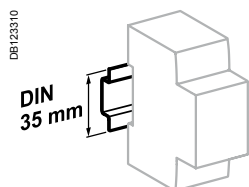

Clip on DIN rail 35 mm.

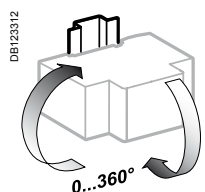

Indifferent position of installation.

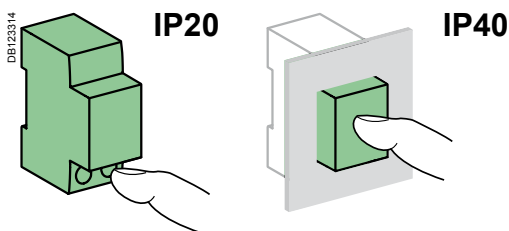

Technical data

| Main characteristics | | | |
|---|---------------------------------|------------------------------------|----------------|
| Insulation voltage (U _i) | | 500 V | |
| Pollution degree | | 3 | |
| Rated impulse withstand voltage (U _{imp}) | | 6 kV | |
| According to IEC/EN 61008-1 | | | |
| Making and breaking capacity (I _m /I _{Δm}) | | 1500 A | |
| Surge current withstand (8/20 μs) without tripping | AC and A types (no selective Ⓢ) | 250 Å | |
| | AC, A types (selective Ⓢ) | 3 kÅ | |
| | S/I type | 3 kÅ | |
| Conditional rated short circuit current (I _{nc} /I _{Δc}) | With iC60N/H/L | Equal to breaking capacity of iC60 | |
| | With fuse | 10,000 A | |
| Additional characteristics | | | |
| Degree of protection | Device only | IP20 | |
| | Device in modular enclosure | IP40 Insulation classe II | |
| Endurance (O-C) | Electrical (AC1) | 16 to 63 A | 15,000 cycles |
| | | 80 to 100 A | 10,000 cycles |
| | Mechanical | | 20,000 cycles |
| Operating temperature | AC type | | -5°C to +60°C |
| | A and S/I types | | -25°C to +60°C |
| Storage temperature | | | -40°C to +85°C |

iID residual current circuit breakers (AC, A, S/I types) (cont.)

Weight (g)

| Residual current circuit breakers | |
|-----------------------------------|-----|
| Type | iID |
| 2P | 210 |
| 4P | 370 |

Dimensions (mm)

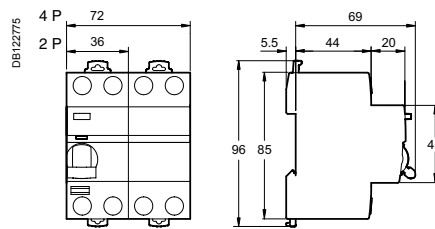

iID residual current circuit breakers (AC, A, *SI* types) (cont.)

PB104548-40



PB104472-40

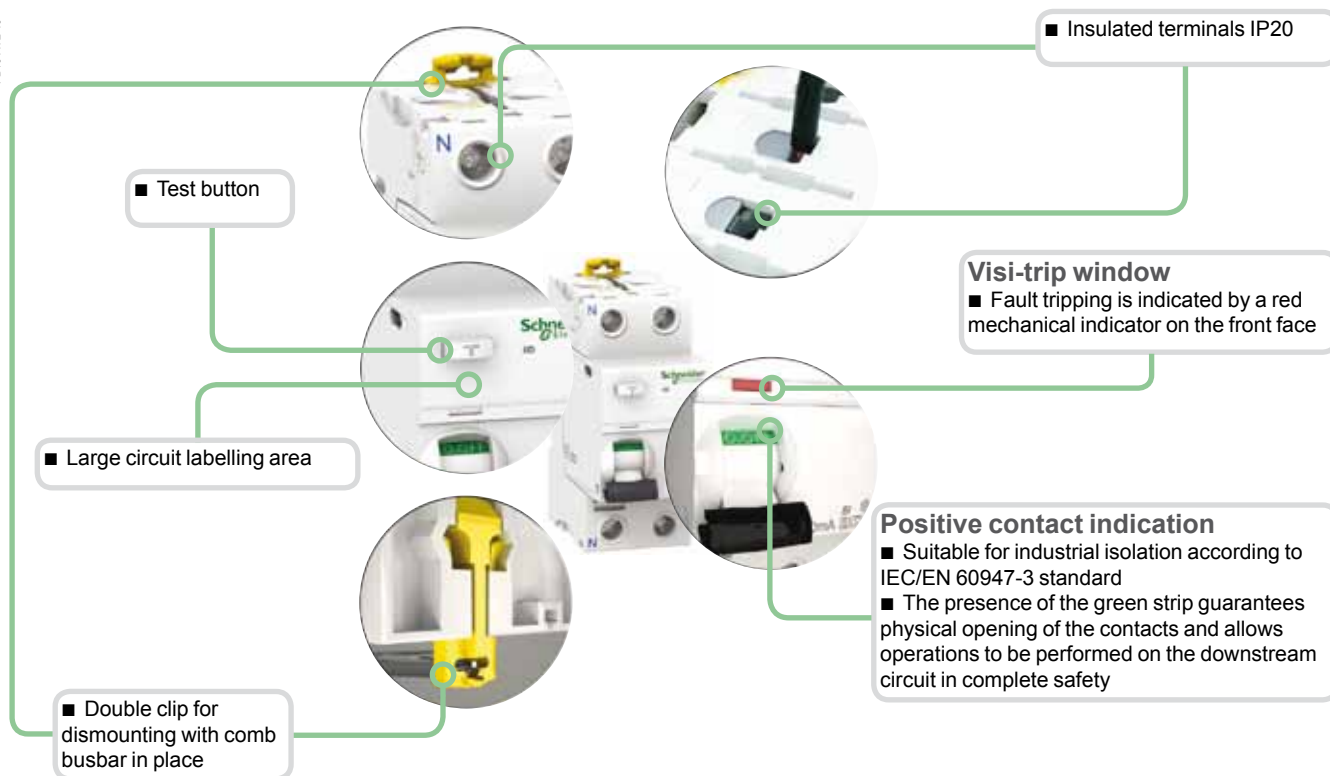

SI type

The *SI* type provides increased immunity from electrical interference and polluted or corrosive environments.

iID double terminals residual current circuit breakers (AC type)

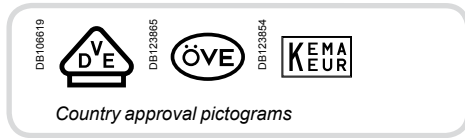

Country approval pictograms

KEMA KEUR approval, only for 2P/4P 25 A to 63 A catalogue numbers.

IEC/EN 61008-1



- The iID double tunnel terminals residual current circuit breakers provide:
 - protection of persons against electric shock by direct contact (≤ 30 mA),
 - protection of persons against electric shock by indirect contact (≥ 100 mA),
 - protection of installations against the risk of fire (300 mA).

Catalogue numbers

| iID double terminals residual current circuit breakers | | | | | | | | | | | |
|--|---|-------------|----------|--------------|----------|----------|---------------|----------|----------|----------------------|---|
| Type | AC | | | | | | | | | | |
| Product | iID | | | | | | | | | | |
| Auxiliaries | Can accept auxiliaries, module CA907002 | | | | | | | | | | |
| 2P | Sensitivity | 10 mA | 30 mA | 30 mA Type G | 100 mA | 100 mA | 100 mA Type G | 300 mA | 300 mA | Width in 9 mm module | |
| | Rating | 25 A | A9Z10225 | A9Z11225 | - | - | - | A9Z14225 | - | 4 | |
| | 40 A | - | A9Z11240 | A9Z76240 | A9Z12240 | - | A9Z77240 | A9Z14240 | A9Z15240 | | |
| | 63 A | - | A9Z11263 | A9Z76263 | A9Z12263 | - | A9Z77263 | A9Z14263 | A9Z15263 | | |
| | 80 A | - | A9Z11280 | - | A9Z12280 | - | - | A9Z14280 | A9Z15280 | | |
| | 100 A | - | A9Z11291 | - | A9Z12291 | - | - | A9Z14291 | A9Z15291 | | |
| | Rating | 25 A | - | A9Z11425 | - | - | - | A9Z14425 | - | 8 | |
| | 40 A | - | A9Z11440 | - | A9Z12440 | - | - | A9Z14440 | A9Z15440 | | |
| | 63 A | - | A9Z11463 | - | A9Z12463 | - | - | A9Z14463 | A9Z15463 | | |
| | 80 A | - | A9Z11480 | A9Z76480 | A9Z12480 | - | A9Z77480 | A9Z14480 | A9Z15480 | | |
| | 100 A | - | A9Z11491 | A9Z76491 | A9Z12491 | - | A9Z77491 | A9Z14491 | A9Z15491 | | |
| | Rating | 40 A | - | A9Z71440 | A9Z78440 | A9Z72440 | A9Z73440 | A9Z79440 | A9Z74440 | A9Z75440 | 8 |
| | 63 A | - | A9Z71463 | A9Z78463 | A9Z72463 | A9Z73463 | A9Z79463 | A9Z74463 | A9Z75463 | | |
| Voltage rating (Ue) | 2P | 230 - 240 V | | | | | | | | | |
| | 4P | 400 - 415 V | | | | | | | | | |
| Operating frequency | 50/60 Hz | | | | | | | | | | |
| Accessories | Module CA907000 and CA907001 | | | | | | | | | | |

iID double terminals residual current circuit breakers (A type)

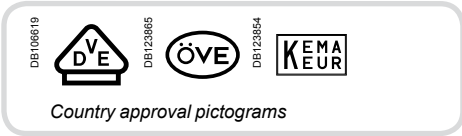

IEC/EN 61008-1

KEMA KEUR approval, only for 2P/4P 25 A to 63 A catalogue numbers.



- The iID double tunnel terminals residual current circuit breakers provide:
 - protection of persons against electric shock by direct contact (≤ 30 mA),
 - protection of persons against electric shock by indirect contact (≥ 100 mA),
 - protection of installations against the risk of fire (300 mA or 500 mA).

Catalogue numbers

| iID double terminals residual current circuit breakers | | | | | | | | | | |
|--|---|--------------|--------------|---------------|----------------|---------------|----------------|---------------|----------------------|---|
| Type | A | | | | | | | | Width in 9 mm module | |
| Product | iID | | | | | | | | | |
| Auxiliaries | Can accept auxiliaries, module CA907002 | | | | | | | | | |
| 2P | Sensitivity | 10 mA | 30 mA | 100 mA | 100 mA | 300 mA | 300 mA | 500 mA | | |
| | Rating | 16 A | A9Z20216 | - | - | - | - | - | 4 | |
| | | 25 A | A9Z20225 | A9Z21225 | - | - | A9Z24225 | - | | |
| | | 40 A | - | A9Z21240 | A9Z22240 | - | A9Z24240 | A9Z25240 | | |
| | | 63 A | - | A9Z21263 | A9Z22263 | - | A9Z24263 | A9Z25263 | | |
| | | 80 A | - | A9Z21280 | A9Z22280 | - | A9Z24280 | A9Z25280 | | |
| | | 100 A | - | A9Z21291 | A9Z22291 | - | A9Z24291 | A9Z25291 | | |
| 4P | Sensitivity | 10 mA | 30 mA | 100 mA | 100 mA | 300 mA | 300 mA | 500 mA | | |
| | Rating | 25 A | - | A9Z21425 | - | - | A9Z24425 | - | A9Z26425 | 8 |
| | | 40 A | - | A9Z21440 | A9Z22440 | - | A9Z24440 | A9Z25440 | A9Z26440 | |
| | | 63 A | - | A9Z21463 | A9Z22463 | - | A9Z24463 | A9Z25463 | A9Z26463 | |
| | | 80 A | - | A9Z21480 | A9Z22480 | - | A9Z24480 | A9Z25480 | A9Z26480 | |
| | | 100 A | - | A9Z21491 | A9Z22491 | - | A9Z24491 | A9Z25491 | A9Z26491 | |
| 4P Type THV | Sensitivity | 10 mA | 30 mA | 100 mA | 100 mA | 300 mA | 300 mA | 500 mA | | |
| | Rating | 40 A | - | A9Z81440 | A9Z82440 | A9Z83440 | - | - | - | 8 |
| | | 63 A | - | A9Z81463 | A9Z82463 | A9Z83463 | - | - | - | |
| Voltage rating (Ue) | 2P | 230 - 240 V | | | | | | | | |
| | 4P | 400 - 415 V | | | | | | | | |
| Operating frequency | 50/60 Hz | | | | | | | | | |
| Accessories | Module CA907000 and CA907001 | | | | | | | | | |

iID double terminals residual current circuit breakers (S/I type)

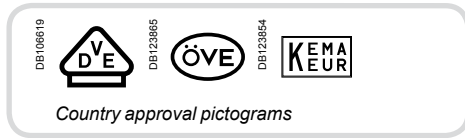

Country approval pictograms

KEMA KEUR approval, only for 2P/4P 25 A to 63 A catalogue numbers.

IEC/EN 61008-1



- The iID double tunnel terminals residual current circuit breakers provide:
 - protection of persons against electric shock by direct contact (≤ 30 mA),
 - protection of persons against electric shock by indirect contact (≥ 100 mA),
 - protection of installations against the risk of fire (300 mA).

The **S/I** type provides increased immunity from electrical interference and polluted or corrosive environments.

Catalogue numbers

| iID double terminals residual current circuit breakers | | | | | | | | |
|--|---|--------------|--------------|---------------|---------------|---------------|----------------------|----------|
| Type | S/I | | | | | | Width in 9 mm module | |
| Product | iID | | | | | | | |
| Auxiliaries | Can accept auxiliaries, module CA907002 | | | | | | | |
| 2P | Sensitivity | 10 mA | 30 mA | 100 mA | 100 mA | 300 mA | 4 | |
| | Rating | 25 A | A9Z31225 | A9Z31225 | - | - | | |
| | | 40 A | - | A9Z31240 | A9Z32240 | - | | A9Z35240 |
| | | 63 A | - | A9Z31263 | A9Z32263 | - | | A9Z35263 |
| | | 80 A | - | A9Z31280 | A9Z32280 | - | | A9Z35280 |
| | | 100 A | - | A9Z31291 | A9Z32291 | - | | A9Z35291 |
| 4P | Sensitivity | 10 mA | 30 mA | 100 mA | 100 mA | 300 mA | 8 | |
| | Rating | 25 A | - | A9Z31425 | - | - | | |
| | | 40 A | - | A9Z31440 | A9Z32440 | - | | A9Z35440 |
| | | 63 A | - | A9Z31463 | A9Z32463 | - | | A9Z35463 |
| | | 80 A | - | A9Z31480 | A9Z32480 | - | | A9Z35480 |
| | | 100 A | - | A9Z31491 | A9Z32491 | - | | A9Z35491 |
| 4P Type THV | Sensitivity | 10 mA | 30 mA | 100 mA | 100 mA | 300 mA | 8 | |
| | Rating | 40 A | - | - | - | A9Z93440 | | A9Z95440 |
| | | 63 A | - | - | - | A9Z93463 | A9Z95463 | |
| Voltage rating (Ue) | 2P | 230 - 240 V | | | | | | |
| | 4P | 400 - 415 V | | | | | | |
| Operating frequency | 50/60 Hz | | | | | | | |
| Accessoires | Module CA907000 and CA907001 | | | | | | | |

iID double terminals residual current circuit breakers (AC, A, S/I types) (cont.)

Connection between double-terminal protection devices

With comb busbar at the back/cables at the front

Without comb busbar at the back/cables at the front

DB404815



| | | Back | Front | |
|--------|-------------------|------------------------|-------------------------|-------------------------|
| Rating | Tightening torque | Comb busbar | Copper cables | |
| | | Thickness of the teeth | Rigid | Flexible or ferrule |
| All | 3.5 N.m | 1.5 mm | DB122945 | DB122946 |
| | | | 1 to 35 mm ² | 1 to 25 mm ² |

Connection between double-terminal and single-terminal protection devices

Cables at the back/comb busbar at the front

DB404817



| | | Back | Front | |
|--------|-------------------|-------------------------|-------------------------|------------------------|
| Rating | Tightening torque | Copper cables | | Comb busbar |
| | | Rigid | Flexible or ferrule | Thickness of the teeth |
| All | 3.5 N.m | DB122945 | DB122946 | 1.5 mm |
| | | 1 to 25 mm ² | 1 to 16 mm ² | |

■ Connection by comb busbar or by cable (according to EN 50027).

Connection

DB123847

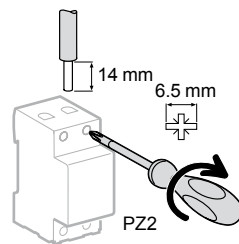

With accessories

| Rating | 50 mm ² Al terminal | Screw-on connection for ring terminal | Multi-cables terminal | |
|--------|--------------------------------|---------------------------------------|------------------------|------------------------|
| | | | Rigid cables | Flexible cables |
| All | DB122935 | DB118789 | DB118787 | |
| | 50 mm ² | Ø 5 mm | 3 x 16 mm ² | 3 x 10 mm ² |

iID double terminals residual current circuit breakers (AC, A, S/ types)

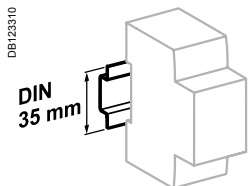

Clip on DIN rail 35 mm.

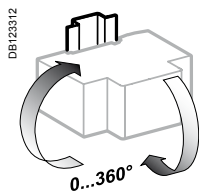

Indifferent position of installation.

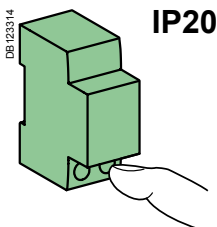

IP20

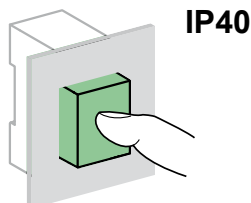

IP40

Dimensions (mm)

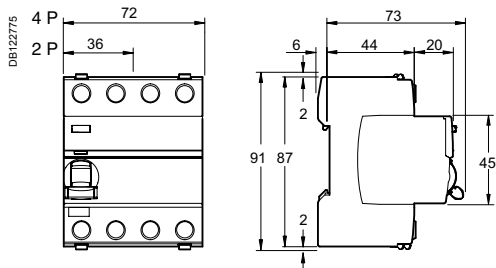

Technical data

Main characteristics

| | |
|--|-------|
| Insulation voltage (Ui) | 500 V |
| Pollution degree | 3 |
| Rated impulse withstand voltage (Uimp) | 6 kV |

According to IEC/EN 61008-1

| | | |
|--|--|------------------------------------|
| Making and breaking capacity (Im/IΔm) | 1500 A | |
| Surge current withstand (8/20 μs) without tripping | AC and A types (no selective \square) | 250 kA |
| | AC, A types (selective \square) | 3 kA |
| | S/ type | 3 kA |
| Conditional rated short circuit current (Inc/IΔc) | With iC60N/H/L | Equal to breaking capacity of iC60 |
| | With fuse | 10,000 A |

Additional characteristics

| | | | |
|-----------------------|-----------------------------|------------------------------|---------------|
| Degree of protection | Device only | IP20 | |
| | Device in modular enclosure | IP40 Insulation classe II | |
| Endurance (O-C) | Electrical (AC1) | 16 to 63 A | 15,000 cycles |
| | | 80 to 100 A | 10,000 cycles |
| | Mechanical | 20,000 cycles | |
| Operating temperature | AC type | -5°C to +60°C | |
| | A and S/ types | -25°C to +60°C | |
| Storage temperature | | -40°C to +85°C | |

Weight (g)

iID double terminals residual current circuit breakers

| Type | iID |
|------|-----|
| 2P | 210 |
| 4P | 370 |

iID double terminals residual current circuit breakers (AC, A, *SI* types) (cont.)

PB107414-40



PB107413-60

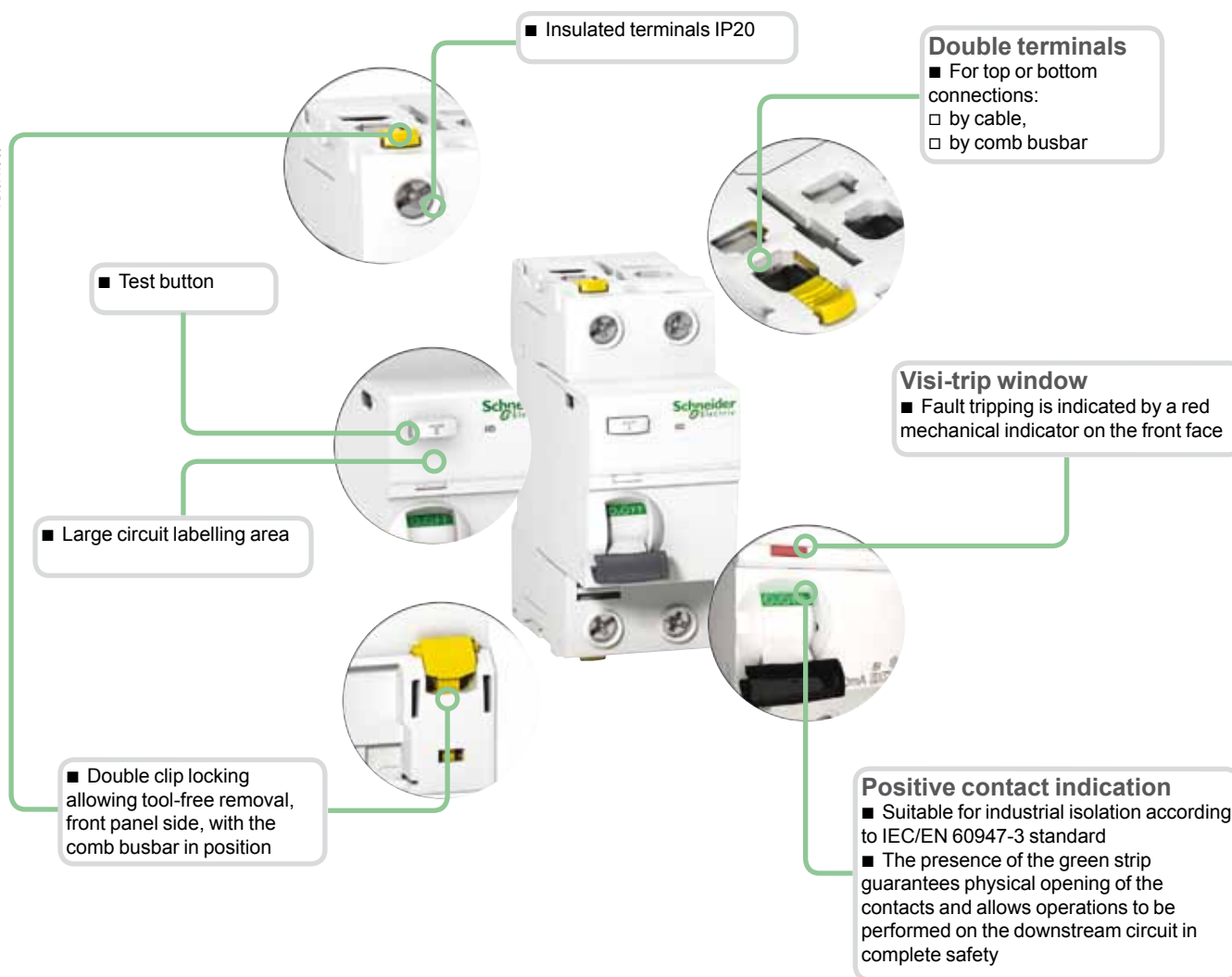

SI type

The *SI* type provides increased immunity from electrical interference and polluted or corrosive environments.

Schneider Electric's range of residual current circuit breakers consists of different products (B, C, D) to enable it to be the most competitive range possible in each country, allowing for the special characteristics of each market:

- usual installation procedure
- price
- accreditations by local bodies.

Variants

| Offers | | Pages |
|--------------|-------------------|-------|
| Offer B/C | Catalogue numbers | 168 |
| Offer D | Catalogue numbers | 169 |
| Common pages | | 170 |

DB123523



Only the product range to be marketed in your country and validated by the local product manager, in agreement with his Final Distribution (FD) partner should be retained. The others will be removed before publication.

DB123524



IEC/EN 61008-1



- The iID K residual current circuit breakers provide:
 - protection of persons against electric shock by direct contact (30 mA),
 - protection of persons against electric shock by indirect contact (300 mA)
 - protection of installations against the risk of fire (300 mA).

PB104497-40



Catalogue numbers

iID K residual current circuit breakers

| Product | AC | iID K | | Width in 9-mm modules | |
|---------------------|--------------------|---------------------|---------------|-----------------------|---|
| | | Without auxiliaries | | | |
| Auxiliaries | | 30 mA | 300 mA | | |
| 2P | Sensitivity | 30 mA | 300 mA | | |
| | Rating | 25 A | A9R50225 | A9R75225 | 4 |
| | | 40 A | A9R50240 | A9R75240 | |
| 4P | Sensitivity | 30 mA | 300 mA | | |
| | Rating | 25 A | A9R50425 | A9R75425 | 8 |
| | | 40 A | A9R50440 | A9R75440 | |
| | | 63 A | A9R70463 | A9R75463 | |
| Voltage rating (Ue) | 2P | 230 - 240 V | | | |
| | 4P | 400 - 415 V | | | |
| Operating frequency | 50/60 Hz | | | | |

PB104497-40

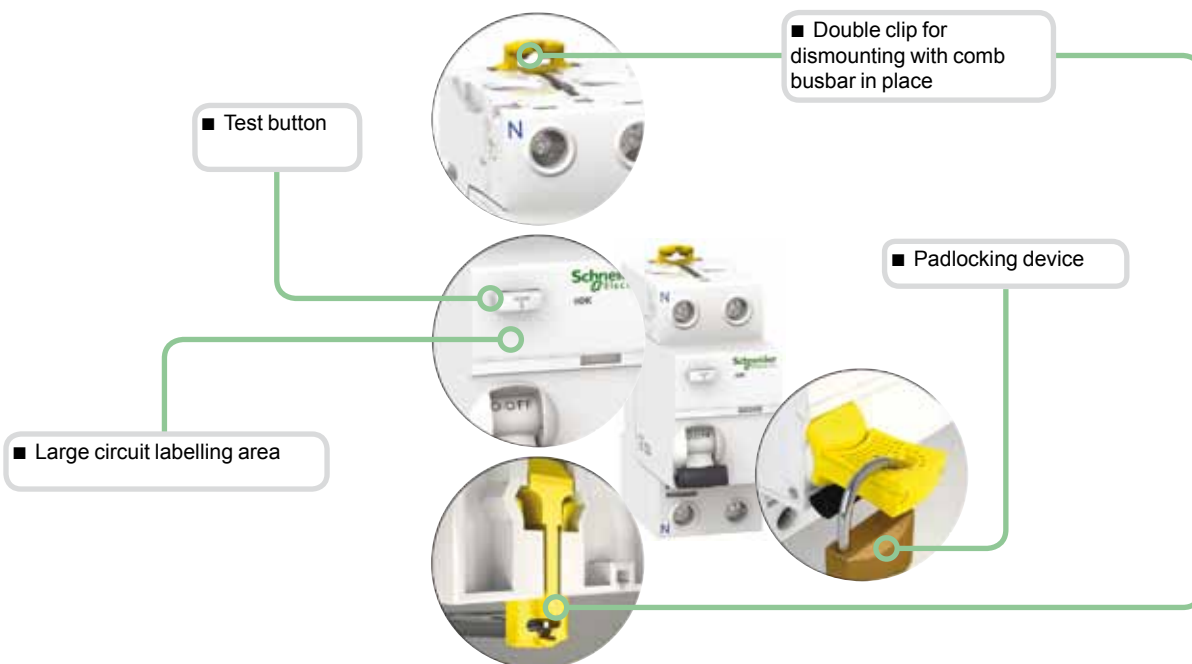

IEC/EN 61008-1

DB123400



Country approval pictograms

- The iID K residual current circuit breakers provide:
 - protection of persons against electric shock by direct contact (30 mA),
 - protection of persons against electric shock by indirect contact (300 mA)
 - protection of installations against the risk of fire (300 mA).

PB104497-40

PB104497-40



Catalogue numbers

| iID K residual current circuit breakers | | AC | | Width in 9-mm modules | |
|---|-------------|---------------------|-----------------|-----------------------|-----------------|
| Product | Auxiliaries | iID K | | | |
| | | Without auxiliaries | | | |
| 2P | | Sensitivity | | | |
| | | 30 mA | 300 mA | | |
| | Rating | 25 A | A9R60225 | 4 | |
| | | 40 A | A9R60240 | | A9R75225 |
| | Rating | 25 A | A9R50425 | 8 | |
| | | 40 A | A9R50440 | | A9R75440 |
| | | 63 A | A9R70463 | | A9R75463 |
| Voltage rating (Ue) | | 2P | 230 - 240 V | | |
| | | 4P | 400 - 415 V | | |
| Operating frequency | | 50/60 Hz | | | |

PB104497-40

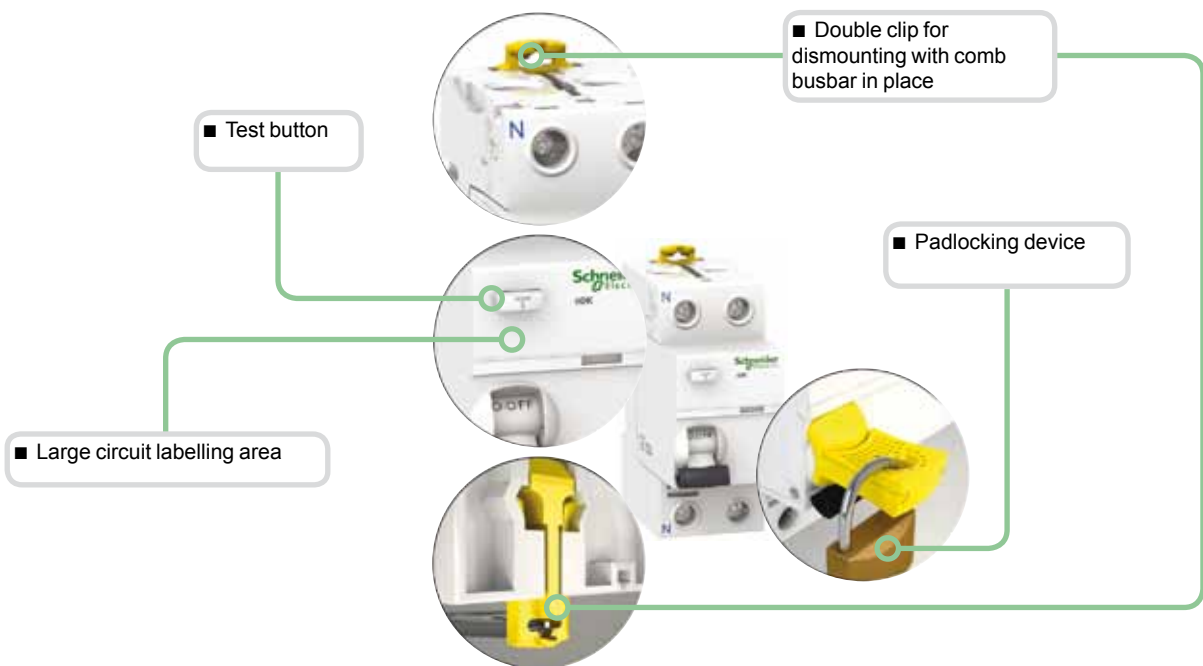

iID K residual current circuit breakers (cont.)

Connection

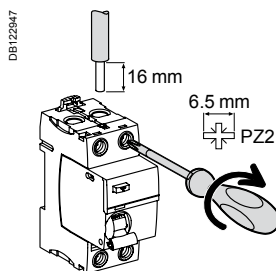

| Type | Tightening torque | Without accessory | |
|-------|-------------------|-------------------------|-------------------------|
| | | Copper cables Rigid | Flexible or ferrule |
| iID K | 3.5 N.m | 1 to 35 mm ² | 1 to 25 mm ² |

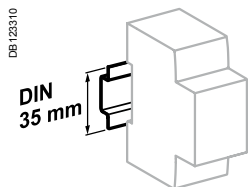

Clip on DIN rail 35 mm.

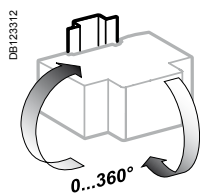

Indifferent position of installation.

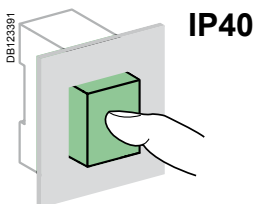

Technical data

Main characteristics

According to IEC/EN 61008-1

| | |
|---|---------------------------------|
| Insulation voltage (U _i) | 440 V |
| Pollution degree | 2 |
| Rated impulse withstand voltage (U _{imp}) | 4 kV |
| Making and breaking capacity (I _m /I _{Δm}) | 25 to 40 A 63 A |
| Surge current withstand (8/20 μs) without tripping | 500 A 630 A |
| Conditional rated short circuit current (I _{nc} /I _{Δc}) | Up to 200 Å 6000 A 4500 A |

Additional characteristics

| | | |
|-----------------------|-----------------------------|-------------------|
| Degree of protection | Device in modular enclosure | IP40 |
| Endurance (O-C) | Electrical | 2000 cycles (AC1) |
| | Mechanical | 5000 cycles |
| Operating temperature | | -5°C to +60°C |
| Storage temperature | | -40°C to +85°C |

Weight (g)

Residual current circuit breakers

| Type | iID K |
|------|-------|
| 2P | 210 |
| 4P | 370 |

Dimensions (mm)

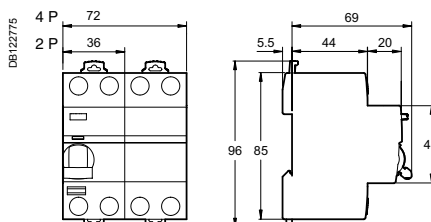



IEC/EN 61008-1



- The ID K Biconnect residual current circuit breakers offer the following functions:
 - protection of persons against electric shock by direct contact (≤ 30 mA),
 - protection of persons against electric shock by indirect contact (300 mA),
 - protection of installations against the risks of fire (300 mA).

Catalogue numbers

| ID K Biconnect residual current circuit breakers | | | | | | |
|--|--------------------|-----------------|-----------------|-----------------|-----------------|-----------------------|
| Type | | AC | | A | | Width in 9 mm modules |
| 2P | Sensitivity | 30 mA | 300 mA | 30 mA | 300 mA | 4 |
| | Rating 25 A | A9Z05225 | - | A9Z01225 | - | |
| | 40 A | A9Z05240 | - | A9Z01240 | - | |
| 4P | Sensitivity | 30 mA | 300 mA | 30 mA | 300 mA | 8 |
| | Rating 25 A | A9Z05425 | - | A9Z01425 | - | |
| | 40 A | A9Z05440 | A9Z06440 | A9Z01440 | A9Z04440 | |
| | 63 A | A9Z05463 | A9Z06463 | A9Z01463 | A9Z04463 | |
| Operating voltage (Ue) | 2P | 230 - 240 V | | | | |
| | 4P | 400 - 415 V | | | | |
| Operating frequency | 50 Hz | | | | | |

Catalogue numbers

| ID K Biconnect residual current circuit breakers Type G | | | | |
|---|--------------------|---------------------|---------------------|-----------------------|
| Type | | AC | AC THV | Width in 9 mm modules |
| 4P | Sensitivity | 30 mA Type G | 30 mA Type G | 8 |
| | Rating 40 A | A9Z07440 | A9Z08440 | |
| Operating voltage (Ue) | 400 - 415 V | | | |
| Operating frequency | 50 Hz | | | |

ID K Biconnect residual current circuit breakers (cont.)

PE110018-40

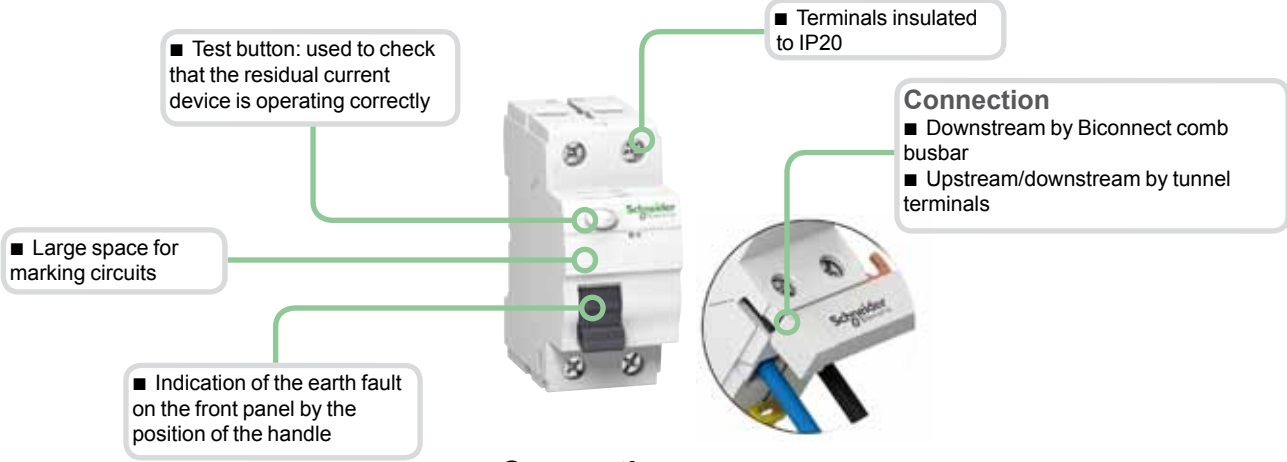

Connection

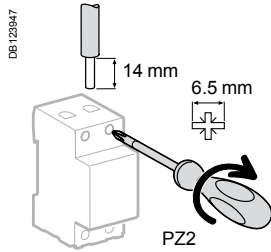

| Type | Tightening torque | Copper cables | |
|----------------|-------------------|-------------------------|--------------------------|
| | | Rigid | Flexible or with ferrule |
| ID K Biconnect | 3.5 N.m | 1 to 35 mm ² | 1 to 25 mm ² |

■ Connection by comb busbar or cables (conforms to EN 50027).

DB123310

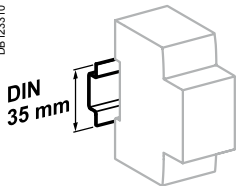

Clip on DIN rail 35 mm.

DB12312

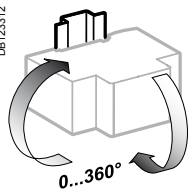

Indifferent position of installation.

DB123314

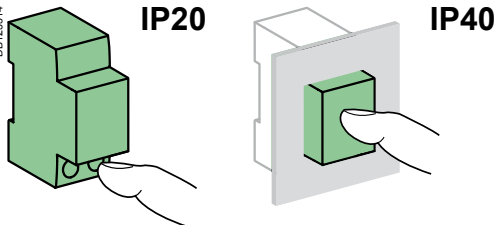

Technical data

| Main characteristics | | |
|---|-------------------------------|-------------------|
| Insulation voltage (U _i) | | 440 V |
| Degree of pollution | | 2 |
| Rated impulse withstand voltage (U _{imp}) | | 4 kV |
| Making and breaking capacity (I _m /I _{Δm}) | | 500 A |
| Impulse current withstand (8/20 μs) without tripping | | Up to 200 Å |
| Conditional rated short-circuit current (I _{nc} /I _{Δc}) | With circuit breaker | 6000 A |
| | With fuse | 4500 A |
| Additional characteristics | | |
| Degree of protection | Device only | IP20 |
| | Device in a modular enclosure | IP40 |
| Endurance (O-C) | Electrical | 2000 cycles (AC1) |
| | Mechanical | 5000 cycles |
| Operating temperature | AC type | -5°C to +40°C |
| | A type | -25°C to +40°C |
| Storage temperature | | -30°C to +70°C |

Weight (g)

| Residual current circuit breakers | |
|-----------------------------------|----------------|
| Type | ID K Biconnect |
| 2P | 180 |
| 4P | 350 |

Dimensions (mm)

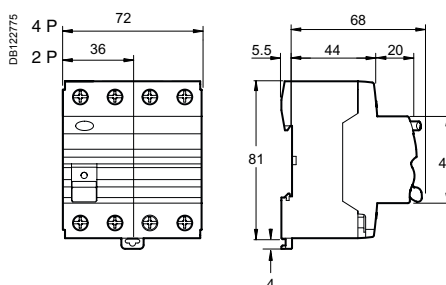



The Schneider Electric range of residual current circuit breakers comprises various offers (Clario, Prodis, Libro) so as to be as competitive as possible in each country, taking into account the specific features of each market:

- installation customs
- price
- approval by local organizations.

Variants

| Offers | | Pages |
|--------------|-------------------|-------|
| Clario | Catalogue numbers | 174 |
| Prodis | Catalogue numbers | 175 |
| Librio | Catalogue numbers | 176 |
| Common pages | | 177 |

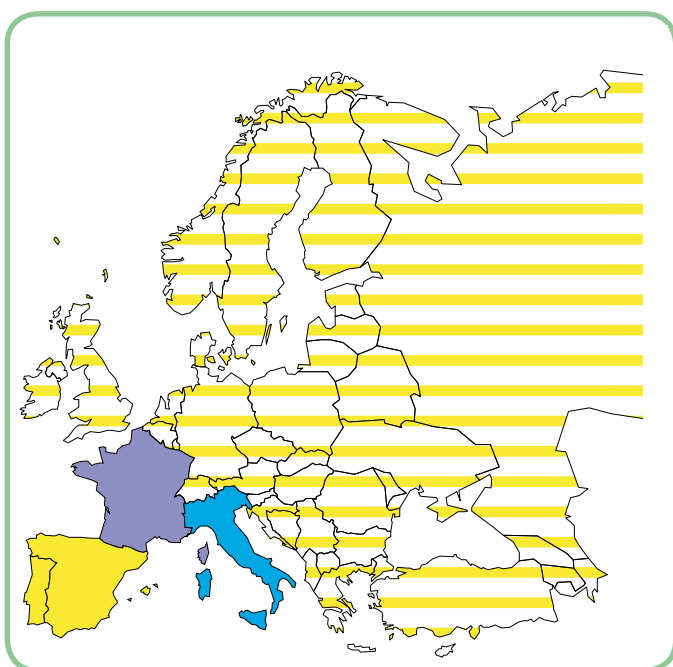

Only the product range to be marketed in your country and validated by the local product manager, in agreement with his Final Distribution (FD) partner should be retained. The others will be removed before publication.

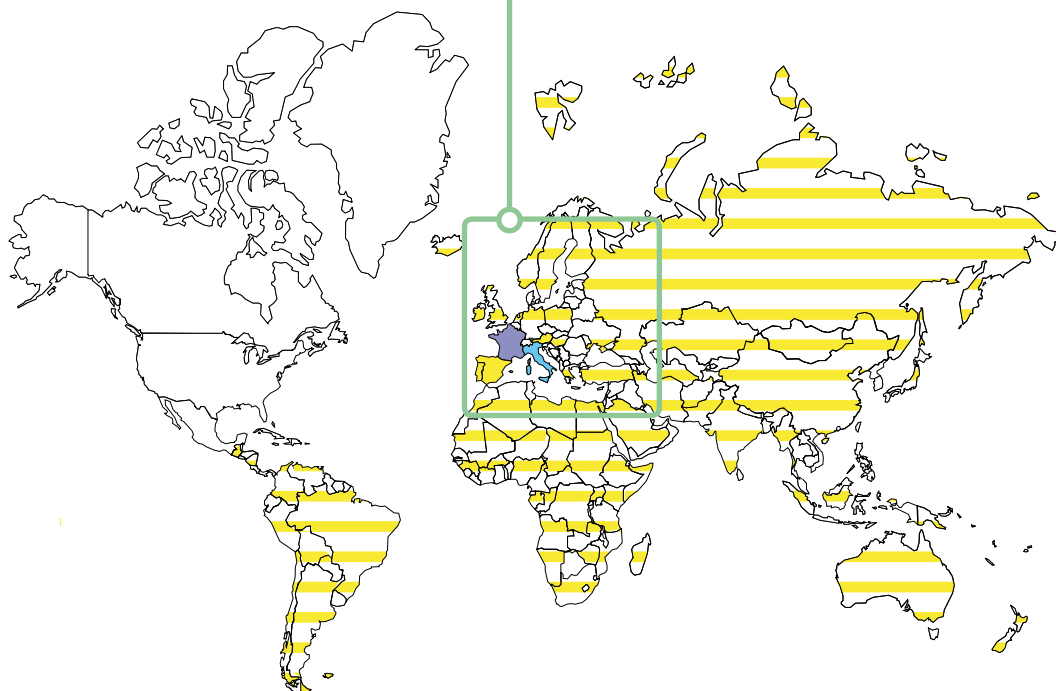

IDc residual current circuit breakers

Clario
Group Feeder

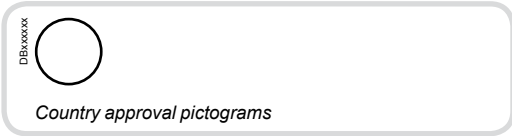

IEC/EN 61008-1, IEC/EN 61008-2-1

Adapted to the needs of service sector and industrial building installations, residual current circuit breakers ensure:

- earth leakage protection of final distribution circuits.
- disconnection.

In accordance with the IEC 61008 standard for residual current devices, a residual current circuit breaker also performs the function of disconnection of electrical circuits.

Residual current circuit breakers include in their enclosure the residual current relay and the toroid. The residual current tripping device is electromechanical and operates without an auxiliary source.

Operation

- When an earth fault occurs, the residual current circuit breaker uses the energy of the fault to perform tripping. Fault indication is performed on the front panel by a mechanical indicator.
- Resetting is performed using the reset handle.

PE107117-32



Catalogue numbers

Residual current circuit breakers

| Type | | AC | SI | Width in 9-mm modules | | | |
|---------------------|--------------------|-------------------------------|---------------|-------------------------------|----------------|----------|---|
| Auxiliaries | | Modules CA907008 and CA907010 | | Modules CA907008 and CA907010 | | | |
| 1P+N | Sensitivity | 30 mA | 300 mA | 30 mA | 300 mA | | |
| | Rating | 25 A | A9N21780 | A9N21781 | A9N21784 | - | 4 |
| | | 40 A | A9N21782 | A9N21783 | A9N21786 | A9N21785 | |
| Voltage rating (Ue) | | 230 V AC | | 230 V AC | | | |
| Operating frequency | | 50 Hz | | 50 Hz | | | |
| Accessories | | Modules CA907010 and CA907012 | | Modules CA907010 and CA907012 | | | |

DE12965

"Group Feeder"

- Residual current circuit breakers are especially suitable for "Group Feeder" protection: the downstream terminals are located in the upper part of the device for direct connection to the comb busbar.



Terminals with guard

- Automatic cable guiding in the correct position

PE107117-40

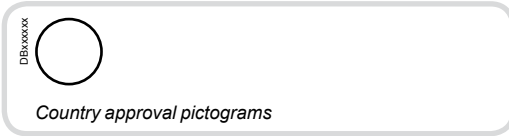

IEC/EN 61008-1, IEC/EN 61008-2-1

Adapted to the needs of service sector and industrial building installations, residual current circuit breakers ensure:

- earth leakage protection of final distribution circuits.
- disconnection.

In accordance with the IEC 61008 standard for residual current devices, a residual current circuit breaker also performs the function of disconnection of electrical circuits.

Residual current circuit breakers include in their enclosure the residual current relay and the toroid. The residual current tripping device is electromechanical and operates without an auxiliary source.

Operation

- When an earth fault occurs, the residual current circuit breaker uses the energy of the fault to perform tripping. Fault indication is performed on the front panel by a mechanical indicator.
- Resetting is performed using the reset handle.

PE107180-32



Prodis

Offer selection see page 173

This sticker must be removed before publishing

Catalogue numbers

| Residual current circuit breakers | | | | | | | |
|-----------------------------------|-------------------------------|-------|-------------------------------|----------|-----------------------|----------|---|
| Type | AC | | SI | | Width in 9-mm modules | | |
| Auxiliaries | Modules CA907008 and CA907010 | | Modules CA907008 and CA907010 | | | | |
| 1P+N | Sensitivity | 30 mA | 300 mA | 30 mA | 300 mA | | |
| | Rating | 25 A | A9N21520 | A9N21522 | A9N21524 | - | 4 |
| | | 40 A | A9N21521 | A9N21523 | A9N21526 | A9N21529 | |
| Voltage rating (Ue) | 230 V AC | | 230 V AC | | | | |
| Operating frequency | 50 Hz | | 50 Hz | | | | |
| Accessories | Modules CA907010 and CA907012 | | Modules CA907010 and CA907012 | | | | |

DE123665

"Group Feeder"

- Residual current circuit breakers are especially suitable for "Group Feeder" protection: the downstream terminals are located in the upper part of the device for direct connection to the comb busbar



Terminals with guard

- Automatic cable guiding in the correct position

PE107180-40

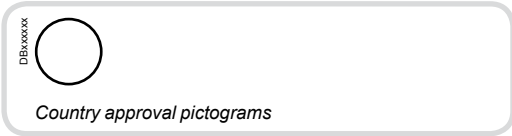

IEC/EN 61008-1, IEC/EN 61008-2-1

Adapted to the needs of service sector and industrial building installations, residual current circuit breakers ensure:

- earth leakage protection of final distribution circuits.
- disconnection.

In accordance with the IEC 61008 standard for residual current devices, a residual current circuit breaker also performs the function of disconnection of electrical circuits.

Residual current circuit breakers include in their enclosure the residual current relay and the toroid. The residual current tripping device is electromechanical and operates without an auxiliary source.

Operation

- When an earth fault occurs, the residual current circuit breaker uses the energy of the fault to perform tripping. Fault indication is performed on the front panel by a mechanical indicator.
- Resetting is performed using the reset handle.



Catalogue numbers

| Residual current circuit breakers | | | | | | | | | |
|-----------------------------------|-------------------------------|------|-------------------------------|----------|-------------------------------|----------|-------------------------------|----------|---|
| Type | AC | | A | | SI | | Width in 9-mm modules | | |
| Auxiliaries | Modules CA907008 and CA907010 | | Modules CA907008 and CA907010 | | Modules CA907008 and CA907010 | | | | |
| 1P+N | Sensitivity | | 30 mA | 300 mA | 30 mA | 300 mA | 30 mA | 300 mA | |
| | Rating | 25 A | A9N19410 | A9N19411 | A9N19414 | A9N19415 | A9N19418 | - | 4 |
| | | 40 A | A9N19412 | A9N19413 | A9N19416 | A9N19417 | A9N19420 | A9N19423 | |
| Voltage rating (Ue) | | | 230 V AC | | 230 V AC | | 230 V AC | | |
| Operating frequency | | | 50 Hz | | 50 Hz | | 50 Hz | | |
| Accessories | | | Modules CA907010 and CA907012 | | Modules CA907010 and CA907012 | | Modules CA907010 and CA907012 | | |

"Group Feeder"

- Residual current circuit breakers are especially suitable for "Group Feeder" protection: the downstream terminals are located in the upper part of the device for direct connection to the comb busbar



Terminals with guard

- Automatic cable guiding in the correct position

Connection

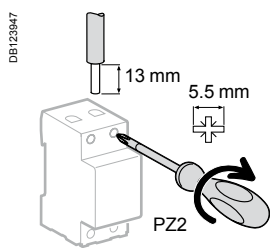

| Rating | Tightening torque | Copper cables | |
|-------------|-------------------|-------------------------|--------------------------|
| | | Rigid | Flexible or with ferrule |
| 25 and 40 A | 2 N.m | DB123945 | DB123946 |
| | | 1 to 16 mm ² | 1 to 10 mm ² |

- Where there is a comb busbar tooth, the connection of cables of cross section 16 mm² remains possible.
- **Connection by comb busbar** or cables (as per EN 50027).

“Group Feeder” connection:

- Upstream: by cables.
- Downstream: direct by comb busbar.

Technical data

| Main characteristics | | |
|---|------------------|---|
| Insulation voltage (U _i) | | 440 V AC |
| Voltage rating (U _e) | Phase-to-neutral | 230 V AC |
| | Phase-to-phase | 400 V AC |
| Rated impulse withstand voltage (U _{imp}) | | 4 kV |
| Positive contact indication | | A green strip on the operating handle guarantees opening of all the poles in safety conditions for work to be carried out on live parts |

| According to EN 61008 | | |
|---|---------------|-------|
| Rated residual breaking and making capacity (I _{Δm}) | | 1 kA |
| Rated breaking and making capacity (I _m) | Instantaneous | 1 kA |
| | Selective | 630 A |
| Rated conditional short-circuit current (I _{nc}) identical to the rated residual short-circuit current (I _{Δc}) | Instantaneous | 6 kA |
| | Selective | 630 A |

| Additional characteristics | | |
|----------------------------------|-----------------------------|---|
| Degree of protection (IEC 60529) | Device only | IP20 |
| | Device in modular enclosure | IP40 |
| Operating temperature | AC Types | -5°C to +40°C |
| | A, S/I types | -25°C to +40°C |
| Storage temperature | | -40°C to +70°C |
| Tropicalization (IEC 60068-1) | | Treatment 2 (relative humidity of 95 % at 55°C) |

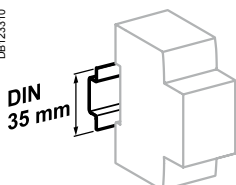

Clip on DIN rail 35 mm.

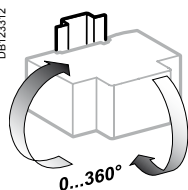

Indifferent position of installation.

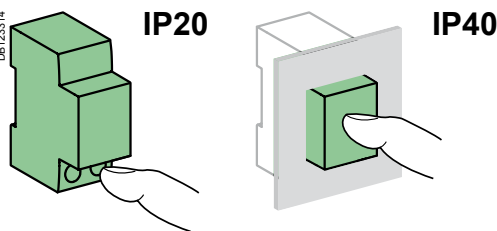

Dimensions (mm)

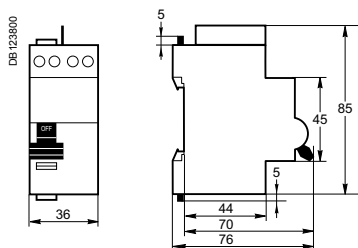

Weight (g)

| Residual current circuit breakers | |
|-----------------------------------|-----|
| Type | |
| 1P+N | 205 |

RCCB-ID 125 A residual current circuit breaker (AC, A, SI types)

IEC/EN 61008-1, VDE 0664

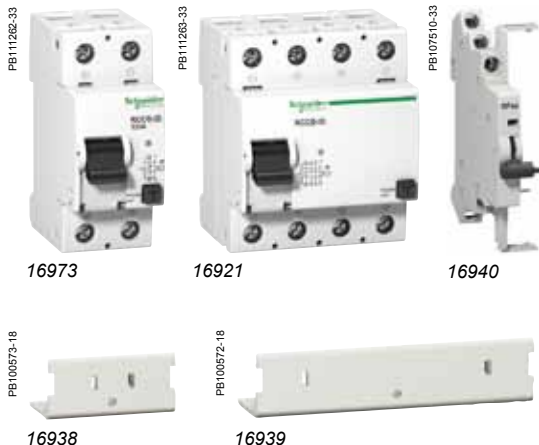

- The RCCB-ID 125 A residual current circuit breakers provide:
 - protection of persons against electric shock by direct contact (30 mA),
 - protection of persons against electric shock by indirect contact (≥ 100 mA),
 - protection of installations against the risk of fire (300 mA or 500 mA).

The *SI* type provides increased immunity from electrical interference and polluted or corrosive environments.

OFsp auxiliary

- Electrical indication: by OFsp auxiliary mounted to the left, it has a double changeover switch indicating the "open" or "closed" position of the RCCB-ID 125 A.

Accessories

- 2P and 4P sealable screw shield.

Catalogue numbers

| RCCB-ID 125 A residual current circuit breakers | | | | | | | | | | | | | |
|---|-------------|-------|--------|--------|--------|-------|--------|--------|--------|-------|--------|----------------------|---|
| Type | | AC | | | | A | | | | SI | | Width in 9 mm module | |
| 2P | Sensitivity | 30 mA | 100 mA | 300 mA | 500 mA | 30 mA | 300 mA | 300 mA | 500 mA | 30 mA | 300 mA | | |
| | Rating | 125 A | 16966 | - | 16967 | - | 16970 | 16971 | - | - | 16972 | 16973 | 4 |
| | | | | | | | | | | | | | |
| | Rating | 125 A | 16905 | 16906 | 16907 | 16908 | 16924 | 16926 | 16925 | 16927 | 16920 | 16921 | 8 |
| | | | | | | | | | | | | | |
| Voltage rating (Ue) | 2P | 230 V | | | | | | | | | | | |
| | 4P | 400 V | | | | | | | | | | | |
| Operating frequency | 50 Hz | | | | | | | | | | | | |

| Auxiliary | | | | |
|-----------|--------------|---------|-----------------|----------------------|
| Type | Contact OFsp | Contact | Voltage | Width in 9 mm module |
| | | 1 A | 110 V DC | 16940 |
| | | 6 A | 230 V AC (AC15) | |

| Accessory | | |
|---|----------------|-------|
| Type | Number of pole | |
| Screw shield (set of 10) for upstream or downstream | 2P | 16938 |
| | 4P | 16939 |

RCCB-ID 125 A residual current circuit breaker (AC, A, S/I types) (cont.)

Connection

■ By tunnel terminals for:

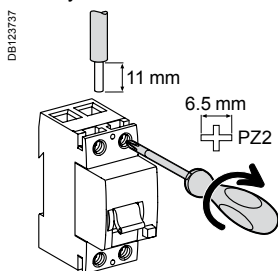

| Type | Tightening torque | Copper cables | |
|---------|-------------------|--|--|
| | | Rigid | Flexible or ferrule |
| RCCB-ID | 3 N.m | 1 x 1.5 to 50 mm ² 2 x 1.5 to 16 mm ² | 1 x 1.5 to 35 mm ² 2 x 1.5 to 16 mm ² |
| OFsp | 0.8 N.m | 1 to 1.5 mm ² | 1 to 1.5 mm ² |

OFsp contact status, depending on the position of the residual current circuit breaker

Type

| | | | | |
|------------------|------------------|--------|--------|--------|
| RCCB-ID 125 A | Closed | ■ | - | - |
| | Open | - | ■ | - |
| | Tripped on fault | - | - | ■ |
| Contact OFsp | 22/21 | Open | Closed | Closed |
| | 12/11 | | | |
| | 14/11 | Closed | Open | Open |

Technical data

Electrical characteristics

| | |
|---|-------|
| Insulation voltage (U _i) | 400 V |
| Pollution degree | 3 |
| Rated impulse withstand voltage (U _{imp}) | 4 kV |

According to IEC/EN 61008-1

| | | |
|---|--|----------|
| Making and breaking capacity (I _m /I _{Δm}) | 1250 A | |
| Surge current withstand (8/20 μs) without tripping | AC and A types (no selective \square) | 250 Å |
| | S/I type (no selective \square) | 3 kÅ |
| | AC, A and S/I types (selective \square) | 3 kÅ |
| Conditional rated short circuit current (I _{nc} /I _{Δc}) | With FU 125 A gG fuse | 10,000 A |

Additional characteristics

| | | |
|-----------------------|-----------------------------|--------------------------------|
| Degree of protection | Device only | IP20 IP40 with screw shield |
| | Device in modular enclosure | IP40 Insulation classe II |
| Endurance (O-C) | Electrical | > 2 000 cycles |
| | Mechanical | > 5 000 cycles |
| Operating temperature | | -25°C to +40°C |
| Storage temperature | | -40°C to +85°C |



Indication of the status of the RCCB-ID via the 3-position toggle and front panel indicator

- Closed (red indicator)
- Tripped on fault (green indicator)
- Open (green indicator)

Weight (g)

Residual current circuit breakers and auxiliary

| Type | RCCB-ID 125 A | OFsp |
|------|---------------|------|
| 2P | 230 | 40 |
| 4P | 420 | |

Dimensions (mm)

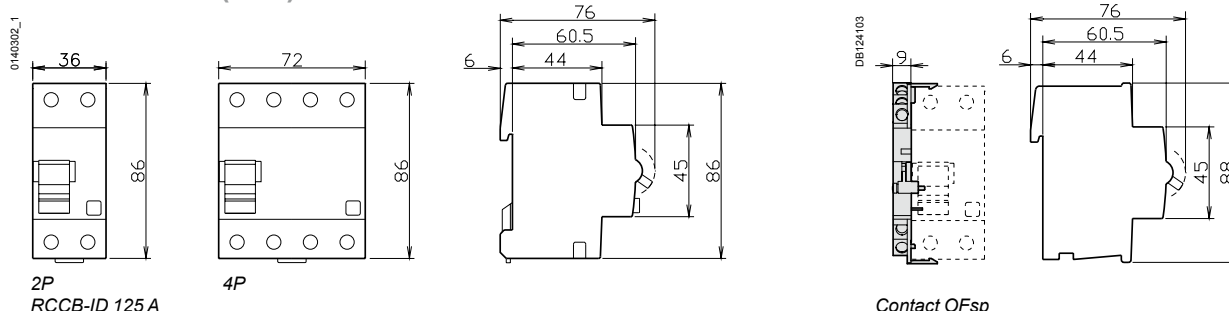

IEC/EN 61008, VDE 0664



16766



16940



16939

- The RCCB-ID 125 A residual current circuit breakers provide:
 - protection of persons against electric shock by direct contact (30 mA),
 - protection of persons against electric shock by indirect contact (≥ 300 mA),
 - protection of installations against the risk of fire (300 mA or 500 mA).

B type

The RCCB-ID B type residual current circuit breakers provide:

- protection in the event of a continuous fault current on three-phase networks generated by:
 - controllers and variable speed drives,
 - battery chargers and inverters,
 - backed-up power supplies.

■ They include and also guarantee protection against fault currents:

- sinusoidal AC residual currents (AC type),
- pulsed DC residual currents (A type).

They can be adapted to all the application cases defined in standards IEC 60364 and EN 50178.

■ Schneider Electric guarantees that the type B RCCB-ID works correctly in combination with the variable speed drives manufactured by Schneider Electric.





OFsp auxiliary

- Electrical indication: by OFsp auxiliary mounted to the left.
- It has a double changeover switch indicating the "open" or "closed" position of the RCCB-ID B type .

Accessories

- 4P sealable screw shield.

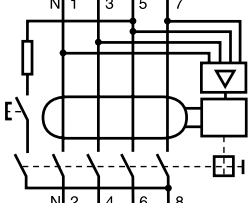
Catalogue numbers

| RCCB-ID B type residual current circuit breakers | | | | | | | | |
|---|--------|-------|-------|--|--|--------|---|----------------------|
| Type | | | | B   | | | | Width in 9 mm module |
| 4P | | | | Sensitivity | | | | |
|  | Rating | 25 A | 30 mA | 300 mA | 300 mA  | 500 mA | 8 | |
| | | 40 A | 16750 | 16751 | - | - | | |
| | | 63 A | 16752 | 16753 | 16754 | 16755 | | |
| | | 80 A | 16756 | 16757 | 16758 | 16759 | | |
| | | 125 A | 16760 | 16761 | 16762 | - | | |
| Voltage rating (Ue) | | | | 230/400 V | | | | |
| Operating frequency | | | | 50 Hz | | | | |

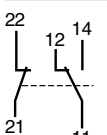
| Auxiliary | | | | |
|---|---------|-----------------|-------|----------------------|
| Type | | | | Width in 9 mm module |
| Contact OFsp | | | | |
|  | Contact | Voltage | 16940 | 1 |
| | 1 A | 110 V DC | | |
| | 6 A | 230 V AC (AC15) | | |

| Accessory | | |
|---|----------------|-------|
| Type | Number of pole | |
| Screw shield (set of 10) for upstream or downstream | 4P | 16939 |

Connection

■ By tunnel terminals for:

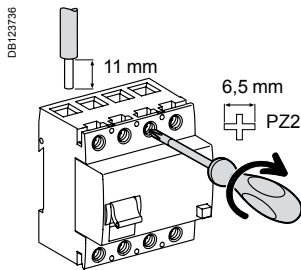

| Type | Tightening torque | Copper cables | |
|----------------|-------------------|--------------------------|--------------------------|
| | | Rigid | Flexible or ferrule |
| RCCB-ID B type | 3 N.m | DB112804 | DB112805 |
| OFsp | 0.8 N.m | 1 to 1.5 mm ² | 1 to 1.5 mm ² |

OFsp contact status, depending on the position of the residual current circuit breaker

| Type | | | | |
|----------------|------------------|--------|--------|--------|
| RCCB-ID B type | Closed | ■ | - | - |
| | Open | - | ■ | - |
| | Tripped on fault | - | - | ■ |
| Contact OFsp | 22/21 12/11 | Open | Closed | Closed |
| | 14/11 | Closed | Open | Open |

Technical data

| Electrical characteristics | | |
|---|--------------------------------|--------------------------------|
| Insulation voltage (U _i) | | 400 V |
| Pollution degree | | 3 |
| Rated impulse withstand voltage (U _{imp}) | | 4 kV |
| According to IEC/EN 61008-1 | | |
| Making and breaking capacity (I _m /I _{Δm}) | 25/40 A | 500 A |
| | 63/80 A | 800 A |
| | 125 A | 1250 A |
| Surge current withstand (8/20 μs) without tripping | No selective ☒ | 250 Å |
| | Selective ☑ | 3 kÅ |
| Conditional rated short circuit current (I _{nc} /I _{Δc}) | 25/40 A with FU 80 A gG fuse | 10,000 A |
| | 63 A with FU 100 A gG fuse | 10,000 A |
| | 80/125 A with FU 125 A gG fuse | 10,000 A |
| Additional characteristics | | |
| Degree of protection | Device only | IP20 IP40 with screw shield |
| | Device in modular enclosure | IP40 Insulation classe II |
| Endurance (O-C) | Electrical | > 2 000 cycles |
| | Mechanical | > 5 000 cycles |
| Operating temperature | | -25°C to +40°C |
| Storage temperature | | -40°C to +85°C |



Indication of the status of the RCCB-ID B type via the 3-position toggle and front panel indicator

- Closed (red indicator)
- Tripped on fault (green indicator)
- Open (green indicator)

Weight (g)

| Residual current circuit breakers and auxiliary | | |
|---|----------------|------|
| Type | RCCB-ID B type | OFsp |
| 4P | 450 | 40 |

Dielectric test

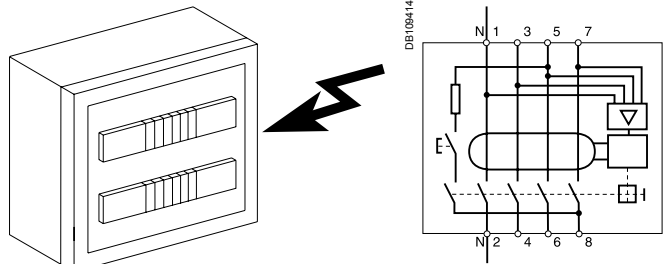

⚠ To perform the dielectric test, disconnect terminals 3, 5, 7 and 4, 6, 8.

Dimensions (mm)

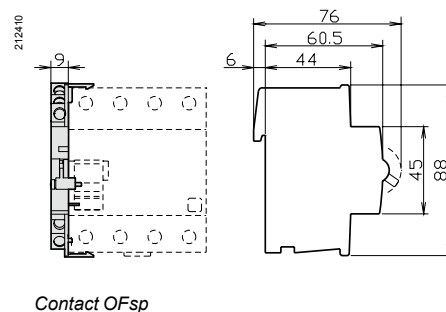
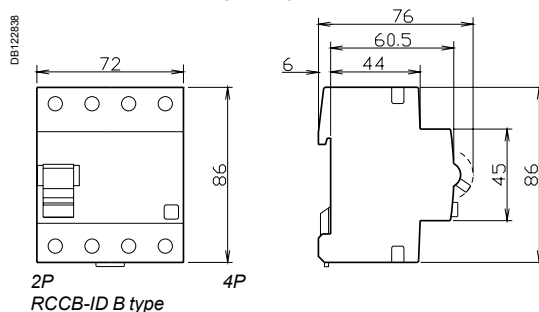



Schneider Electric's range of add-on residual current devices (A, B, C, D, E) to enable it to be the most competitive range possible in each country, allowing for the special characteristics of each market:

- usual installation procedure
- price
- accreditations by local bodies.

Variants

| Offers | Catalogue numbers | Pages |
|--------------------|-------------------|-------------|
| Offer A | Catalogue numbers | 183 and 190 |
| Offer B | Catalogue numbers | 186 and 190 |
| Offer C | Catalogue numbers | 189 and 190 |
| Offer D Quick Vigi | Catalogue numbers | 10 and 16 |
| Offer E Quick Vigi | Catalogue numbers | 13 and 16 |
| Common pages | | 191 |



Only the product range to be marketed in your country and validated by the local product manager, in agreement with his Final Distribution (FD) partner should be retained. The others will be removed before publication.

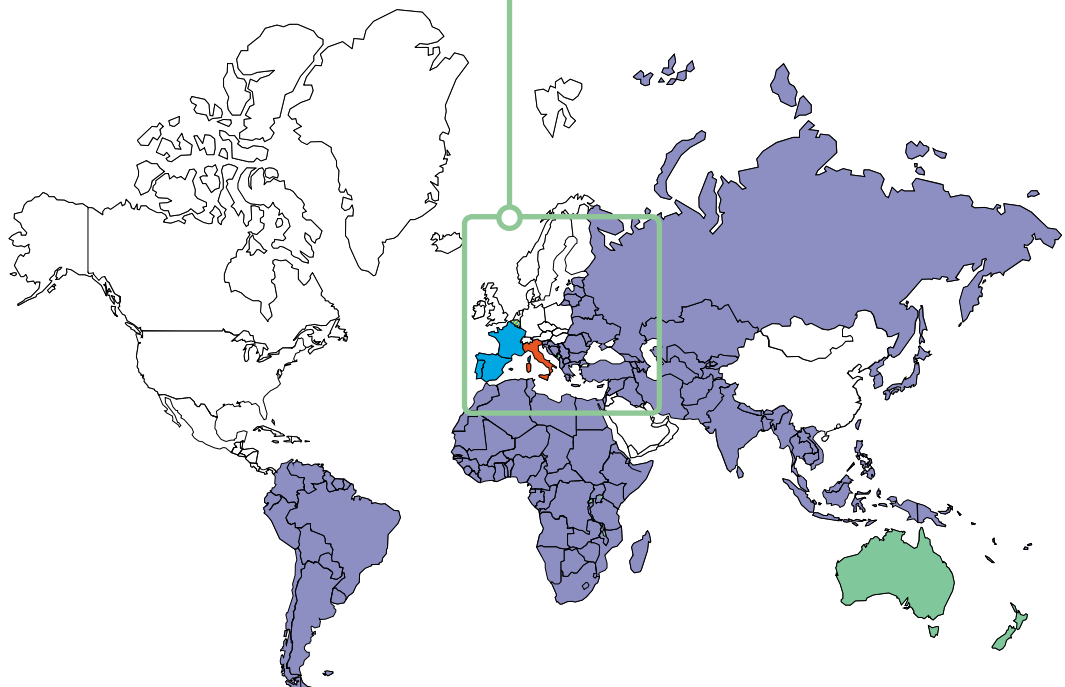

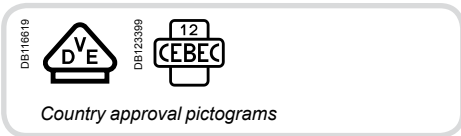

IEC/EN 61009-1

PB104466-35



- Combined with iC60 circuit breaker, the Vigi iC60 provide:
 - protection of persons against electric shock by direct contact (≤ 30 mA),
 - protection of persons against electric shock by indirect contact (≥ 100 mA),
 - protection of installations against the risk of fire (300 mA or 500 mA).

Catalogue numbers

| Vigi iC60 add-on residual current devices | | | | | | | | | | |
|---|---------------------|--|----------|-----------------------|----------|-----------------------|----------|----------|----------|-----------------------|
| Type | AC | | | | | | | | | Width in 9 mm modules |
| Product | Vigi iC60 | | | | | | | | | |
| Auxiliaries | Without auxiliaries | | | | | | | | | |
| 2P | Sensitivity | 10 mA | 30 mA | 100 mA | 300 mA | 500 mA | 300 mA | 1000 mA | | |
| DB122462 | Rating | 25 A | A9V10225 | A9V11225 A9V01225* | A9V12225 | A9V14225 A9V04225* | A9V16225 | - | - | 3 |
| | | 40 A | - | A9V11240 A9V01240* | - | A9V14240 A9V04240* | A9V16240 | - | - | 4 |
| | | 63 A | - | A9V11263 A9V01263* | A9V12263 | A9V14263 A9V04263* | A9V16263 | A9V15263 | A9V19263 | 4 |
| DB122463 | Rating | 25 A | - | A9V11325 | - | A9V14325 | A9V16325 | - | - | 6 |
| | | 40 A | - | A9V11340 | - | A9V14340 | A9V16340 | - | - | 7 |
| | | 63 A | - | A9V11363 | - | A9V14363 | A9V16363 | A9V15363 | A9V19363 | 7 |
| DB122464 | Rating | 25 A | - | A9V11425 | A9V12425 | A9V14425 | A9V16425 | - | - | 6 |
| | | 40 A | - | A9V11440 | - | A9V14440 | A9V16440 | - | - | 7 |
| | | 63 A | - | A9V11463 | A9V12463 | A9V14463 | A9V16463 | A9V15463 | A9V19463 | 7 |
| Voltage rating (Ue) | | 230 - 240 V, 400 - 415 V Except * 130 V | | | | | | | | |
| Operating frequency | | 50/60 Hz | | | | | | | | |
| Accessories | | Module CA907000 | | | | | | | | |

IEC/EN 61009-1

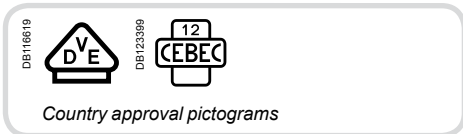

PB 104466-35



- Combined with iC60 circuit breaker, the Vigi iC60 provide:
 - protection of persons against electric shock by direct contact (30 mA),
 - protection of persons against electric shock by indirect contact (≥ 100 mA),
 - protection of installations against the risk of fire (300 mA or 500 mA).

Catalogue numbers

| Vigi iC60 add-on residual current devices | | | | | | | | | | |
|---|---------------------|--------------------------|----------|----------|----------|----------|----------|----------|-----------------------|--|
| Type | A | | | | | | | | Width in 9 mm modules | |
| Product | Vigi iC60 | | | | | | | | | |
| Auxiliaries | Without auxiliaries | | | | | | | | | |
| 2P | Sensitivity | 30 mA | 100 mA | 300 mA | 500 mA | 300 mA | 1000 mA | | | |
| | Rating | 25 A | A9V21225 | A9V22225 | A9V24225 | A9V26225 | - | - | 3 | |
| | | 63 A | A9V21263 | A9V22263 | A9V24263 | A9V26263 | A9V25263 | A9V29263 | 4 | |
| | Rating | 25 A | A9V21325 | A9V22325 | A9V24325 | A9V26325 | - | - | 6 | |
| | | 63 A | A9V21363 | - | A9V24363 | A9V26363 | A9V25363 | A9V29363 | 7 | |
| | Rating | 25 A | A9V21425 | A9V22425 | A9V24425 | A9V26425 | - | - | 6 | |
| | | 63 A | A9V21463 | A9V22463 | A9V24463 | A9V26463 | A9V25463 | A9V29463 | 7 | |
| Voltage rating (Ue) | | 230 - 240 V, 400 - 415 V | | | | | | | | |
| Operating frequency | | 50/60 Hz | | | | | | | | |
| Accessories | | Module CA907000 | | | | | | | | |

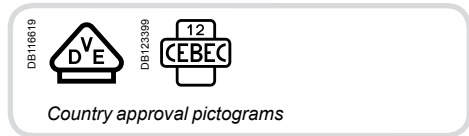

IEC/EN 61009-1

PB 004466-35

Offer selection see page 182

- Combined with iC60 circuit breaker, the Vigi iC60 provide:
 - protection of persons against electric shock by direct contact (≤ 30 mA),
 - protection of persons against electric shock by indirect contact (≥ 300 mA),
 - protection of installations against the risk of fire (300 mA).

offer A

The SI type provides increased immunity from electrical interference and polluted or corrosive environments.

This sticker must be removed before publishing

Catalogue numbers

| Vigi iC60 add-on residual current devices | | | | | | |
|---|---------------------|--------------------------|----------|----------|----------|-----------------------|
| Type | SI | | | | | Width in 9 mm modules |
| Product | Vigi iC60 | | | | | |
| Auxiliaries | Without auxiliaries | | | | | |
| | Sensitivity | 10 mA | 30 mA | 300 mA | 1000 mA | |
| 2P | Rating | 25 A | A9V30225 | A9V31225 | - | 3 |
| | | 40 A | - | A9V31240 | - | 4 |
| | | 63 A | - | A9V31263 | A9V35263 | A9V39263 |
| 3P | Rating | 25 A | - | A9V31325 | - | 6 |
| | | 40 A | - | A9V31340 | - | 7 |
| | | 63 A | - | A9V31363 | A9V35363 | A9V39363 |
| 4P | Rating | 25 A | - | A9V31425 | - | 6 |
| | | 40 A | - | A9V31440 | - | 7 |
| | | 63 A | - | A9V31463 | A9V35463 | A9V39463 |
| Voltage rating (Ue) | | 230 - 240 V, 400 - 415 V | | | | |
| Operating frequency | | 50/60 Hz | | | | |
| Accessories | | Module CA907000 | | | | |

IEC/EN 61009-1



PB 104466-35

PB 104471-35

Offer selection see page 182

- Combined with iC60 circuit breaker, the Vigi iC60 provide:
 - protection of persons against electric shock by direct contact (≤ 30 mA),
 - protection of persons against electric shock by indirect contact (≥ 100 mA),
 - protection of installations against the risk of fire (300 mA or 500 mA).

offer B

This sticker must be removed before publishing

Catalogue numbers

Vigi iC60 add-on residual current devices

| Type | | AC | | | | | | | | Width in 9 mm modules |
|---------------------|--------|--|----------|-----------------------|----------|-----------------------|----------|----------|----------|-----------------------|
| Product | | Vigi iC60 | | | | | | | | |
| Auxiliaries | | Without auxiliaries | | | | | | | | |
| 2P | | Sensitivity | 10 mA | 30 mA | 100 mA | 300 mA | 500 mA | 300 mA | 1000 mA | |
| | Rating | 25 A | A9V10225 | A9V41225 A9V01225* | A9V12225 | A9V44225 A9V04225* | A9V16225 | - | - | 3 |
| | | 40 A | - | A9V41240 A9V01240* | - | A9V44240 A9V04240* | A9V16240 | - | - | 4 |
| | | 63 A | - | A9V41263 A9V01263* | A9V12263 | A9V44263 A9V04263* | A9V16263 | A9V15263 | A9V19263 | 4 |
| | Rating | 25 A | - | A9V41325 | - | A9V44325 | A9V16325 | - | - | 6 |
| | | 40 A | - | A9V41340 | - | A9V44340 | A9V16340 | - | - | 7 |
| | | 63 A | - | A9V41363 | - | A9V44363 | A9V16363 | A9V15363 | A9V19363 | 7 |
| | Rating | 25 A | - | A9V41425 | A9V12425 | A9V44425 | A9V16425 | - | - | 6 |
| | | 40 A | - | A9V41440 | - | A9V44440 | A9V16440 | - | - | 7 |
| | | 63 A | - | A9V41463 | A9V12463 | A9V44463 | A9V16463 | A9V15463 | A9V19463 | 7 |
| Voltage rating (Ue) | | 230 - 240 V, 400 - 415 V Except * 130 V | | | | | | | | |
| Operating frequency | | 50/60 Hz | | | | | | | | |
| Accessories | | Module CA907000 | | | | | | | | |

IEC/EN 61009-1



PB104466-35

Offer selection see page 182

- Combined with iC60 circuit breaker, the Vigi iC60 provide:
 - protection of persons against electric shock by direct contact (30 mA),
 - protection of persons against electric shock by indirect contact (≥ 100 mA),
 - protection of installations against the risk of fire (300 mA or 500 mA).

Offer B

This sticker must be removed before publishing

Catalogue numbers

| Vigi iC60 add-on residual current devices | | | | | | | | | |
|---|---------------------|--------------------------|----------|----------|----------|----------|----------|-----------------------|---|
| Type | A | | | | | | | Width in 9 mm modules | |
| Product | Vigi iC60 | | | | | | | | |
| Auxiliaries | Without auxiliaries | | | | | | | | |
| | Sensitivity | 30 mA | 100 mA | 300 mA | 500 mA | 300 mA | 1000 mA | | |
| 2P DB122462 | Rating | 25 A | A9V51225 | A9V22225 | A9V54225 | A9V26225 | - | 3 | |
| | | 63 A | A9V51263 | A9V22263 | A9V54263 | A9V26263 | A9V25263 | A9V29263 | 4 |
| 3P DB122463 | Rating | 25 A | A9V51325 | A9V22325 | A9V54325 | A9V26325 | - | 6 | |
| | | 63 A | A9V51363 | - | A9V54363 | A9V26363 | A9V25363 | A9V29363 | 7 |
| 4P DB122464 | Rating | 25 A | A9V51425 | A9V22425 | A9V54425 | A9V26425 | - | 6 | |
| | | 63 A | A9V51463 | A9V22463 | A9V54463 | A9V26463 | A9V25463 | A9V29463 | 7 |
| Voltage rating (Ue) | | 230 - 240 V, 400 - 415 V | | | | | | | |
| Operating frequency | | 50/60 Hz | | | | | | | |
| Accessories | | Module CA907000 | | | | | | | |



IEC/EN 61009-1

PB104466-35

PB104471-35

Offer selection see page 182

- Combined with iC60 circuit breaker, the Vigi iC60 provide:
 - protection of persons against electric shock by direct contact (≤ 30 mA),
 - protection of persons against electric shock by indirect contact (≥ 300 mA),
 - protection of installations against the risk of fire (300 mA).

Offer B

The SI type provides increased immunity from electrical interference and polluted or corrosive environments.

This sticker must be removed before publishing

Catalogue numbers

| Vigi iC60 add-on residual current devices | | | | | | | | |
|---|---------------------|--------------------------|----------|----------|----------|----------|-----------------------|--|
| Type | SI | | | | | | Width in 9 mm modules | |
| Product | Vigi iC60 | | | | | | | |
| Auxiliaries | Without auxiliaries | | | | | | | |
| | Sensitivity | 10 mA | 30 mA | 300 mA | 1000 mA | | | |
| 2P DB122462 | Rating | 25 A | A9V30225 | A9V61225 | - | - | 3 | |
| | | 40 A | - | A9V61240 | - | - | 4 | |
| | | 63 A | - | A9V61263 | A9V65263 | A9V39263 | 4 | |
| | | | | | | | | |
| 3P DB122463 | Rating | 25 A | - | A9V61325 | - | - | 6 | |
| | | 40 A | - | A9V61340 | - | - | 7 | |
| | | 63 A | - | A9V61363 | A9V65363 | A9V39363 | 7 | |
| | | | | | | | | |
| 4P DB122464 | Rating | 25 A | - | A9V61425 | - | - | 6 | |
| | | 40 A | - | A9V61440 | - | - | 7 | |
| | | 63 A | - | A9V61463 | A9V65463 | A9V39463 | 7 | |
| | | | | | | | | |
| Voltage rating (Ue) | | 230 - 240 V, 400 - 415 V | | | | | | |
| Operating frequency | | 50/60 Hz | | | | | | |
| Accessories | | Module CA907000 | | | | | | |

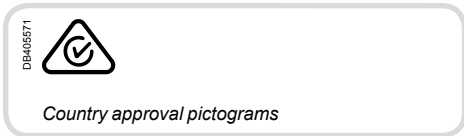

IEC/EN 61009-1

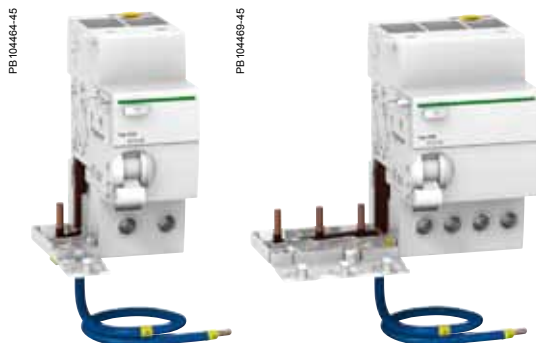

- Combined with iC60 circuit breaker, the Vigi iC60 provide:
 - protection of persons against electric shock by direct contact (30 mA),
 - protection of persons against electric shock by indirect contact (≥ 100 mA),
 - protection of installations against the risk of fire (300 mA).

Catalogue numbers

| Vigi iC60 add-on residual current devices | | | | | | |
|---|------------------------|---|-----------------------|----------|----------|-----------------------|
| Type | A | | | | | Width in 9 mm modules |
| Product | Vigi iC60 | | | | | |
| Auxiliaries | Without auxiliaries | | | | | |
| | | Sensitivity | 30 mA | 100 mA | 300 mA | |
| DB122462 | Rating 25 A 63 A | | | | | 3 |
| | | | A9V02663 A9V01663* | A9V03663 | A9V06663 | 4 |
| DB122464 | Rating 63 A | | | | | |
| | | | A9V02763 | - | A9V06763 | 7 |
| Voltage rating (Ue) | | 230 - 240 V, 400 - 415 V <i>Except * 110 V</i> | | | | |
| Operating frequency | | 50/60 Hz | | | | |
| Accessories | | Module CA907000 | | | | |



Vigi iC60 add-on residual current devices (AC, A, S/ types) (cont.)

PE10456-51



Association iC60a, N, H, L + Vigi iC60

| iC60 | Vigi iC60 25 A | Vigi iC60 40 A | Vigi iC60 63 A |
|---------------|----------------|----------------|----------------|
| 0.5 A to 25 A | ■ | ■ | ■ |
| 32 A - 40 A | NO | ■ | ■ |
| 50 A - 63 A | NO | NO | ■ |

Association iC60 L-MA + Vigi iC60

| iC60 | Vigi iC60 25 A | Vigi iC60 40 A | Vigi iC60 63 A |
|---------------|----------------|----------------|----------------|
| 1.6 A to 16 A | ■ | ■ | ■ |
| 25 A | NO | ■ | ■ |
| 40 A | NO | NO | ■ |

Offer A, B, C

This sticker must be removed before publishing



Combining iC60 L-MA units with Vigi modules of higher rating.

PE10466-40

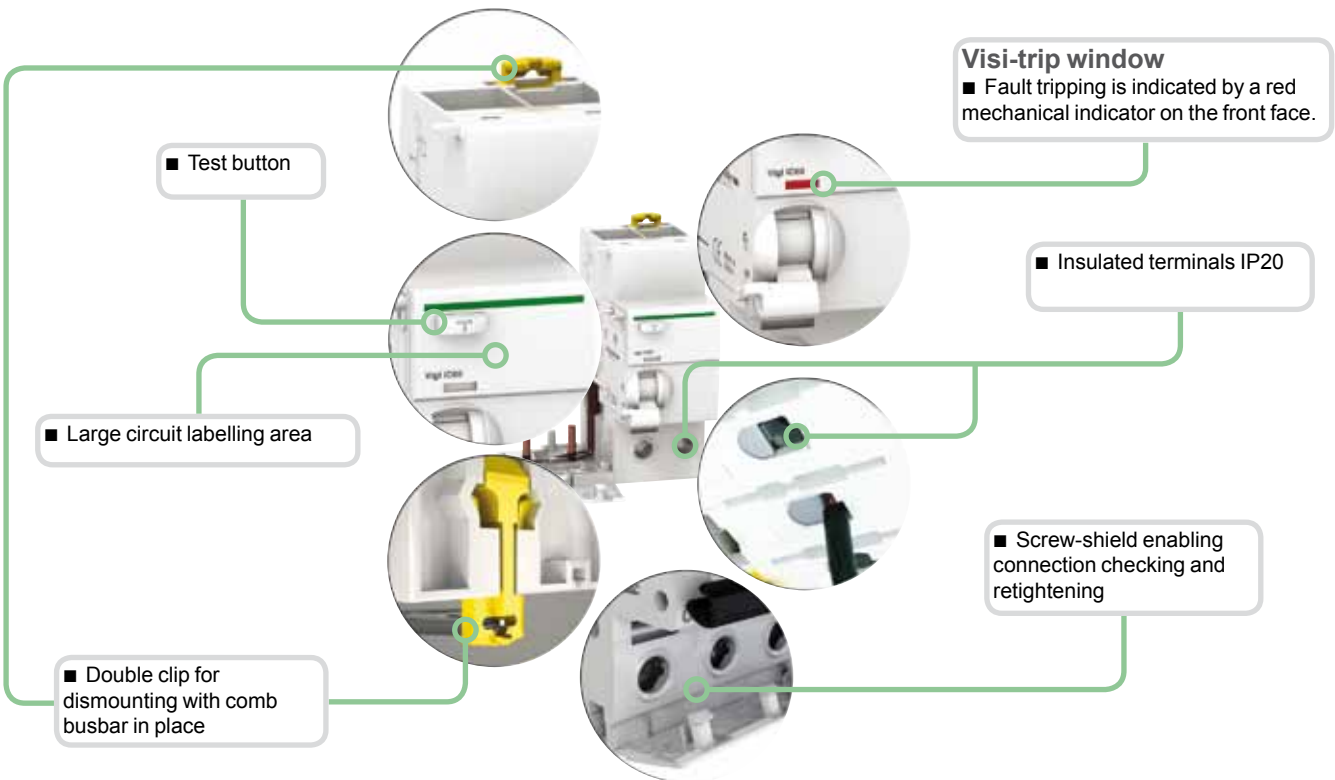

S/ type

The S/ type provides increased immunity from electrical interference and polluted or corrosive environments.

Connection

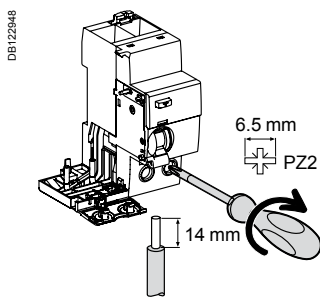

| Type | Rating | Tightening torque | Copper cables | |
|-----------|------------|-------------------|-------------------------|-------------------------|
| | | | Rigid | Flexible or ferrule |
| Vigi iC60 | 25 A | 2 N.m | 1 to 25 mm ² | 1 to 16 mm ² |
| | 40 to 63 A | 3.5 N.m | 1 to 35 mm ² | 1 to 25 mm ² |

DBI122945

DBI122946

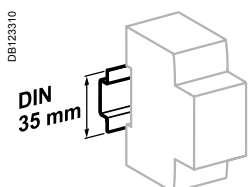

Clip on DIN rail 35 mm.

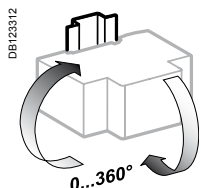

Indifferent position of installation.

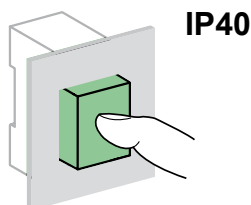
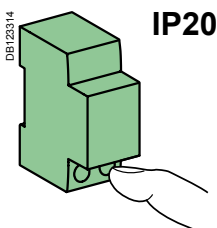

Technical data

Main characteristics

| | |
|---|-------|
| Insulation voltage (U _i) | 500 V |
| Pollution degree | 3 |
| Rated impulse withstand voltage (U _{imp}) | 6 kV |

According to IEC/EN 61009-1

| | | |
|--|--|-------|
| Surge current withstand (8/20 μs) without tripping | AC and A types (no selective \square) | 250 Å |
| | AC, A types (selective \square) | 3 kÅ |
| | <i>SI</i> type | 3 kÅ |

Additional characteristics

| | | |
|-----------------------|-----------------------------|------------------------------|
| Degree of protection | Device only | IP20 |
| | Device in modular enclosure | IP40 Insulation classe II |
| Operating temperature | AC type | -5°C to +60°C |
| | A and <i>SI</i> types | -25°C to +60°C |
| Storage temperature | | -40°C to +85°C |

Vigi iC60 add-on residual current devices (AC, A, S/I types) (cont.)

Weight (g)

Add-on residual current devices

| Type | Vigi iC60 |
|------|-----------|
| 2P | 165 |
| 3P | 210 |
| 4P | 245 |

Dimensions (mm)

Vigi iC60 25 A

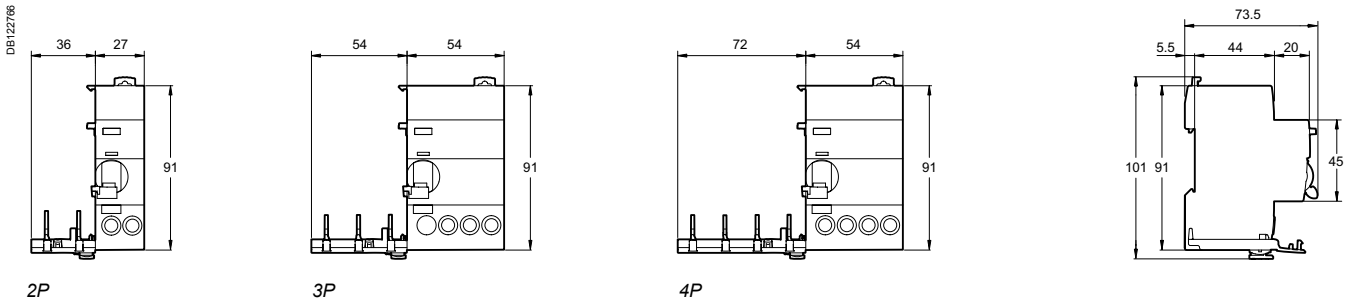

Vigi iC60 40 and 63 A

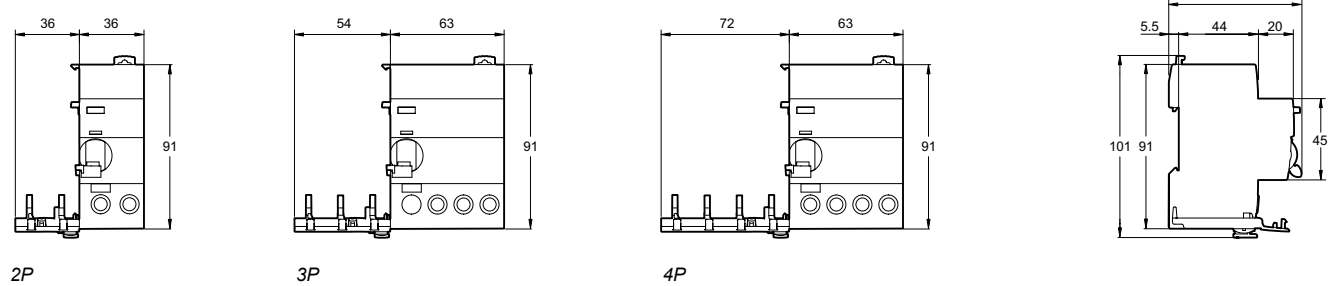

Vigi iC60 add-on residual current devices for iC60 double terminals (AC type)

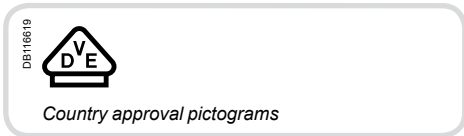

IEC/EN 61009-1

- Combined with iC60 double tunnel terminals circuit breaker, the Vigi iC60 provide:
 - protection of persons against electric shock by direct contact (≤ 30 mA),
 - protection of persons against electric shock by indirect contact (≥ 100 mA),
 - protection of installations against the risk of fire (300 mA).



Catalogue numbers

| Vigi iC60 add-on residual current devices | | | | | | | |
|---|---------------------|-------------|-------------------------------|-----------------------|----------|----------|-----------------------|
| Type | AC | | | | | | Width in 9 mm modules |
| Product | Vigi iC60 | | | | | | |
| Auxiliaries | Without auxiliaries | | | | | | |
| | | Sensitivity | 10 mA | 30 mA | 100 mA | 300 mA | |
| DB40510 | Rating | 25 A | A9W10225 | A9W11225 A9W01225* | A9W12225 | A9W14225 | 3 |
| | | 63 A | - | A9W11263 | A9W12263 | A9W14263 | 4 |
| DB122463 | Rating | 25 A | - | A9W11325 | - | A9W14325 | 6 |
| | | 63 A | - | A9W11363 | - | A9W14363 | 7 |
| DB40511 | Rating | 25 A | - | A9W11425 | A9W12425 | A9W14425 | 6 |
| | | 63 A | - | A9W11463 | A9W12463 | A9W14463 | 7 |
| Voltage rating (Ue) | | | 400 - 415 V Except * 130 V | | | | |
| Operating frequency | | | 50/60 Hz | | | | |
| Accessories | | | Module CA907000 | | | | |

Vigi iC60 add-on residual current devices for iC60 double terminals (A type)

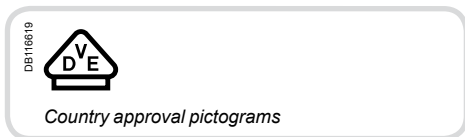

IEC/EN 61009-1

- Combined with iC60 double tunnel terminals circuit breaker, the Vigi iC60 provide:
 - protection of persons against electric shock by direct contact (30 mA),
 - protection of persons against electric shock by indirect contact (≥ 100 mA),
 - protection of installations against the risk of fire (300 mA or 500 mA).

PB10741E-40



PB10741E-40





PB10742E-40



Catalogue numbers

Vigi iC60 add-on residual current devices

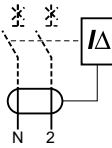
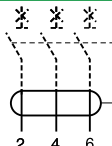
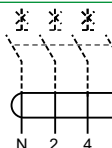
| Type | A  | | | | | | Width in 9 mm modules | |
|---|---|-----------------|----------|----------|--|----------|-----------------------|---|
| Product | Vigi iC60 | | | | | | | |
| Auxiliaries | Without auxiliaries | | | | | | | |
| | Sensitivity | 30 mA | 100 mA | 300 mA | 300 mA  | 500 mA | | |
| DB409510  | Rating | 25 A | A9W21225 | A9W22225 | A9W24225 | - | A9W26225 | 3 |
| | | 63 A | A9W21263 | A9W22263 | A9W24263 | A9W25263 | A9W26263 | 4 |
| DB1224E3  | Rating | 25 A | A9W21325 | - | A9W24325 | - | A9W26325 | 6 |
| | | 63 A | A9W21363 | - | A9W24363 | A9W25363 | A9W26363 | 7 |
| DB409511  | Rating | 25 A | A9W21425 | A9W22425 | A9W24425 | - | A9W26425 | 6 |
| | | 63 A | A9W21463 | A9W22463 | A9W24463 | A9W25463 | A9W26463 | 7 |
| Voltage rating (Ue) | | 400 - 415 V | | | | | | |
| Operating frequency | | 50/60 Hz | | | | | | |
| Accessories | | Module CA907000 | | | | | | |

Vigi iC60 add-on residual current devices for iC60 double terminals (*SI* type)

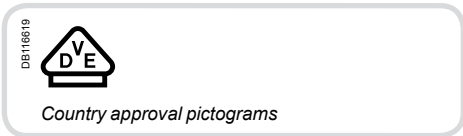

IEC/EN 61009-1

- Combined with iC60 double tunnel terminals circuit breaker, the Vigi iC60 provide:
 - protection of persons against electric shock by direct contact (≤ 30 mA),
 - protection of persons against electric shock by indirect contact (≥ 300 mA),
 - protection of installations against the risk of fire (300 mA).

The *SI* type provides increased immunity from electrical interference and polluted or corrosive environments.



Catalogue numbers

| Vigi iC60 add-on residual current devices | | | | | | |
|---|--------------------|------------------------|-----------------|-----------------|-----------------|-----------------------|
| Type | <i>SI</i> | | | | | Width in 9 mm modules |
| Product | Vigi iC60 | | | | | |
| Auxiliaries | Auxiliaries | | | | | |
| 2P | Sensitivity | 10 mA | 30 mA | 300 mA | | |
| | Rating | 25 A | A9W30225 | A9W31225 | - | 3 |
| | | 63 A | - | A9W31263 | A9W35263 | 4 |
| 3P | Sensitivity | 10 mA | 30 mA | 300 mA | | |
| | Rating | 25 A | - | A9W31325 | - | 6 |
| | | 63 A | - | A9W31363 | A9W35363 | 7 |
| 4P | Sensitivity | 10 mA | 30 mA | 300 mA | | |
| | Rating | 25 A | - | A9W31425 | - | 6 |
| | | 63 A | - | A9W31463 | A9W35463 | 7 |
| Voltage rating (Ue) | | 400 - 415 V | | | | |
| Operating frequency | | 50/60 Hz | | | | |
| Accessories | | Module CA907000 | | | | |

Vigi iC60 add-on residual current devices for iC60 double terminals (AC, A, *SI* types)

Connection

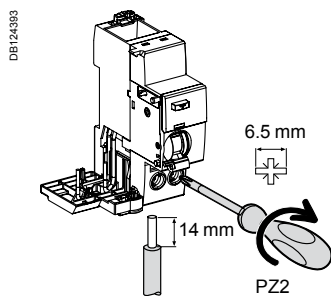

| Type | Rating | Tightening torque | Copper cables | |
|-----------|--------|-------------------|-------------------------|-------------------------|
| | | | Rigid | Flexible or ferrule |
| Vigi iC60 | 25 A | 2 N.m | 1 to 25 mm ² | 1 to 16 mm ² |
| | 63 A | 3.5 N.m | 1 to 35 mm ² | 1 to 25 mm ² |

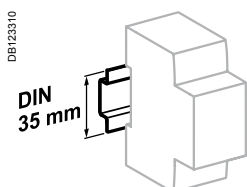

Clip on DIN rail 35 mm.

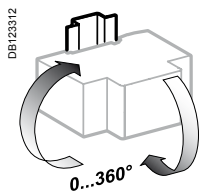

Indifferent position of installation.

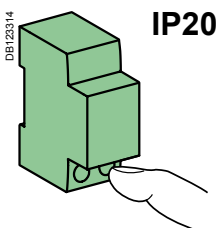

IP20

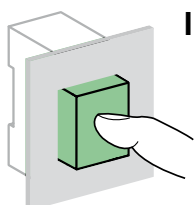

IP40

Technical data

Main characteristics

| | |
|---|-------|
| Insulation voltage (U _i) | 500 V |
| Pollution degree | 3 |
| Rated impulse withstand voltage (U _{imp}) | 6 kV |

According to IEC/EN 61009-1

| | | |
|--|------------------------------------|-------|
| Surge current withstand (8/20 μs) without tripping | AC and A types (no selective) | 250 Å |
| | AC, A types (selective \square) | 3 kÅ |
| | <i>SI</i> type | 3 kÅ |

Additional characteristics

| | | |
|-----------------------|-----------------------------|------------------------------|
| Degree of protection | Device only | IP20 |
| | Device in modular enclosure | IP40 Insulation classe II |
| Operating temperature | AC type | -5°C to +60°C |
| | A and <i>SI</i> types | -25°C to +60°C |
| Storage temperature | | -40°C to +85°C |

Vigi iC60 add-on residual current devices for iC60 double terminals (AC, A, S/I types) (cont.)

Weight (g)

| Add-on residual current devices | |
|---------------------------------|-----------|
| Type | Vigi iC60 |
| 2P | 165 |
| 3P | 210 |
| 4P | 245 |

Dimensions (mm)

Vigi iC60 25 A

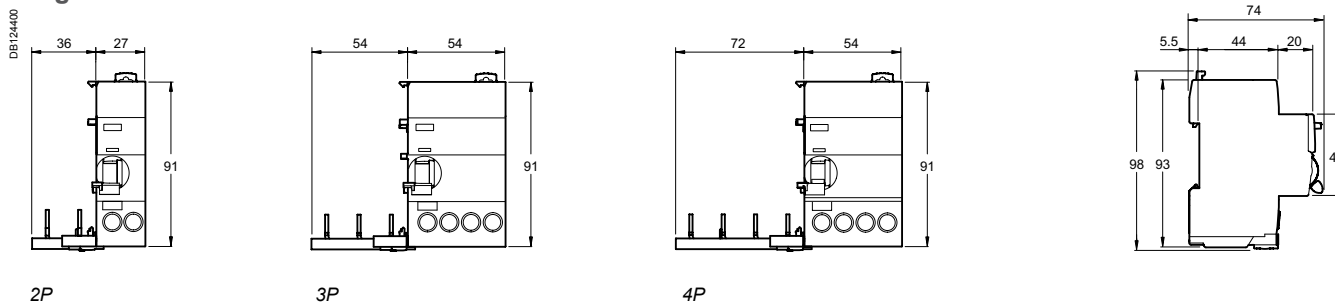

Vigi iC60 63 A

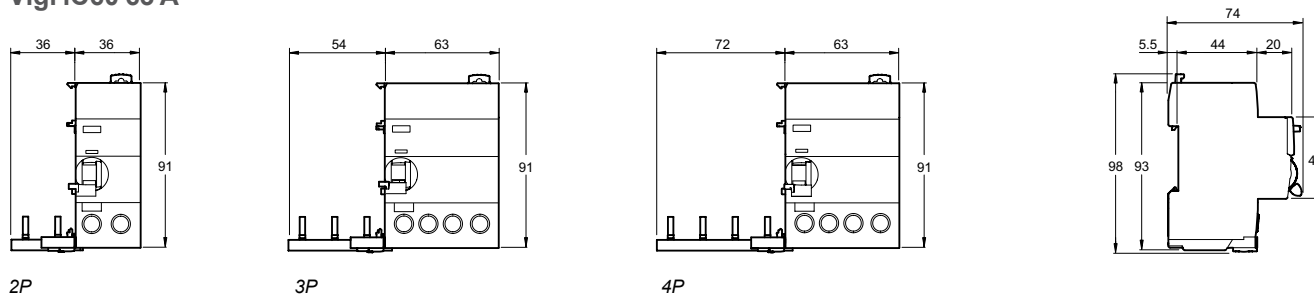

Vigi iC60 add-on residual current devices for iC60 double terminals (AC, A, *SI* types) (cont.)

DB124384



Association iC60N, H, L + Vigi iC60

| iC60 | Vigi iC60 25 A | Vigi iC60 63 A |
|---------------|-------------------|-------------------|
| 0.5 A to 25 A | ■ | ■ |
| 32 A - 40 A | NO | ■ |
| 50 A - 63 A | NO | ■ |

PB1107416-60

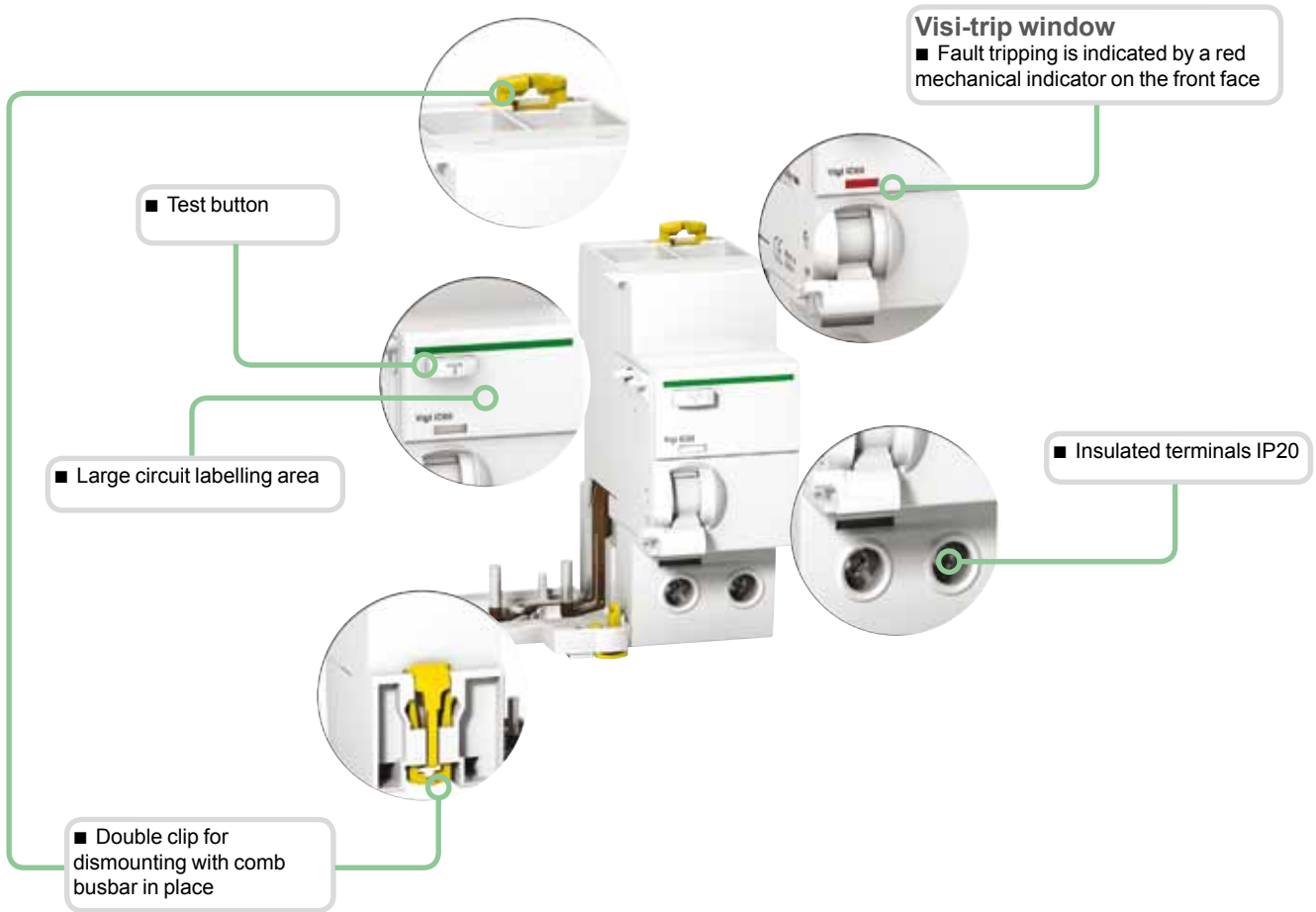

Type *SI*

The *SI* type provides increased immunity from electrical interference and polluted or corrosive environments.

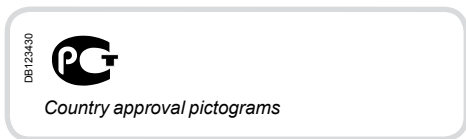

EN 61009



2P



3P



4P

When a Vigi C120 device is combined with a C120 circuit breaker, it provides the following functions:

- protection of persons against electric shock by direct contact (30 mA),
- protection of persons against electric shock by indirect contact (≥ 300 mA),
- protection of installations against fire hazards (300 mA to 1000 mA).

Catalogue numbers

| Vigi C120 add-on residual current devices | | | | | | | |
|---|------------------------------|-------------------------------------|-------------------------------------|----------|----------|-----------------------|----|
| Type | AC | | | | | Width in 9 mm modules | |
| Product | Vigi C120 | | | | | | |
| Auxiliaries | Without auxiliary | | | | | | |
| 2P | Sensitivity | 30 mA | 300 mA | 500 mA | 300 mA | 1000 mA | |
| | | A9N18563 | A9N18564 | A9N18565 | A9N18544 | A9N18545 | 7 |
| 3P | Sensitivity | 30 mA | 300 mA | 500 mA | 300 mA | 1000 mA | |
| | | A9N18566 | A9N18567 | A9N18568 | A9N18546 | A9N18547 | 10 |
| 4P | Sensitivity | 30 mA | 300 mA | 500 mA | 300 mA | 1000 mA | |
| | | A9N18569 A9N18542 ⁽¹⁾ | A9N18570 A9N18543 ⁽¹⁾ | A9N18571 | A9N18548 | A9N18549 | 10 |
| Operating voltage (Ue) | 230...415 V | | | | | | |
| Operating frequency | 50/60 Hz | | | | | | |
| Accessories | Module CA907012 and CA907013 | | | | | | |

(1) specific offer for France

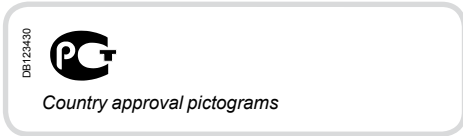

EN 61009

When a Vigi C120 device is combined with a C120 circuit breaker, it provides the following functions:

- protection of persons against electric shock by direct contact (30 mA),
- protection of persons against electric shock by indirect contact (≥ 300 mA),
- protection of installations against fire hazards (300 mA to 1000 mA).



2P



3P



4P

Catalogue numbers

| Vigi C120 add-on residual current devices | | | | | | | | |
|---|-------------------------------------|----------|----------|----------|----------|----------|----------|-----------------------|
| Type | A | | | | | | | Width in 9 mm modules |
| Product | Vigi C120 | | | | | | | |
| Auxiliaries | Without auxiliary | | | | | | | |
| 2P | Sensitivity | 30 mA | 300 mA | 500 mA | 300 mA | 500 mA | 1000 mA | |
| | | A9N18572 | A9N18573 | A9N18574 | - | - | - | 7 |
| 3P | Sensitivity | 30 mA | 300 mA | 500 mA | 300 mA | 500 mA | 1000 mA | |
| | | A9N18575 | A9N18576 | A9N18577 | - | - | - | 10 |
| 4P | Sensitivity | 30 mA | 300 mA | 500 mA | 300 mA | 500 mA | 1000 mA | |
| | | A9N18578 | A9N18579 | A9N18580 | A9N18587 | A9N18588 | A9N18589 | 10 |
| Operating voltage (Ue) | 230...415 V | | | | | | | |
| Operating frequency | 50/60 Hz | | | | | | | |
| Accessories | Module CA907012 and CA907013 | | | | | | | |



EN 61009

When a Vigi C120 device is combined with a C120 circuit breaker, it provides the following functions:

- protection of persons against electric shock by direct contact (30 mA),
- protection of persons against electric shock by indirect contact (≥ 300 mA),
- protection of installations against fire hazards (300 mA to 1000 mA).

Special feature of type S/

They are appropriate for operating in environments with:

- high risk of nuisance tripping: frequent lightning strikes, IT system, presence of electronic ballasts, frequency converters, presence of switchgear incorporating lighting type interference filters, computer system, etc.
- blind sources:
 - presence of harmonics or high frequency rejections
 - presence of DC components: diodes, diode bridges, switch-mode power supplies, etc.
- protected against nuisance tripping caused by transient voltage surges (lightning strike, operation of switchgear on the network, etc.)

PB107924-30



2P

PB107925-30



3P

PB107926-30



4P

Catalogue numbers

| Vigi C120 add-on residual current devices | | | | | | | |
|---|-------------------|-------------------------------------|-------------------------------------|----------|----------|----------|-----------------------|
| Type | S/ | | | | | | Width in 9 mm modules |
| Product | Vigi C120 | | | | | | |
| Auxiliaries | Without auxiliary | | | | | | |
| 2P | Sensitivity | 30 mA | 300 mA | 500 mA | 300 mA | 1000 mA | 7 |
| | | A9N18591 | A9N18592 | - | A9N18556 | A9N18557 | |
| 3P | Sensitivity | 30 mA | 300 mA | 500 mA | 300 mA | 1000 mA | 10 |
| | | A9N18594 | A9N18595 | - | A9N18558 | A9N18559 | |
| 4P | Sensitivity | 30 mA | 300 mA | 500 mA | 300 mA | 1000 mA | 10 |
| | | A9N18597 A9N18554 ⁽¹⁾ | A9N18598 A9N18555 ⁽¹⁾ | A9N18599 | A9N18560 | A9N18561 | |
| Operating voltage (Ue) | | 230...415 V | | | | | |
| Operating frequency | | 50 Hz | | | | | |
| Accessories | | Module CA907012 and CA907013 | | | | | |

(1) specific offer for France

Vigi C120 add-on residual current devices (types AC, A and SI)

Connection

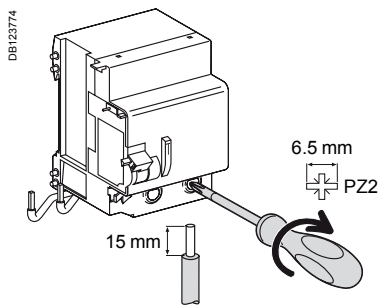

| Type | Sensitivity | Tightening torque | Copper cables | |
|-----------|--------------|-------------------|-------------------------|--------------------------|
| | | | Rigid | Flexible or with ferrule |
| Vigi C120 | 30...1000 mA | 3.5 N.m | 1 to 50 mm ² | 1 to 35 mm ² |

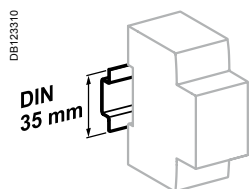

Clips onto 35 mm DIN rail.

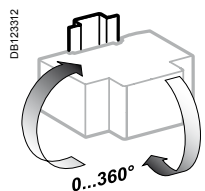

Any installation position.

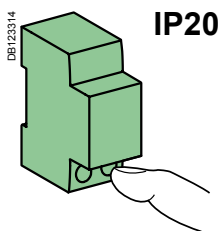

IP20

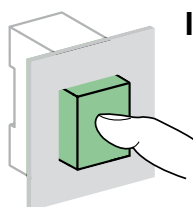

IP40

Technical data

Main characteristics

To IEC 60947-2

| | |
|---|----------|
| Insulation voltage (U _i) | 500 V AC |
| Degree of pollution | 3 |
| Rated impulse withstand voltage (U _{imp}) | 6 kV |

To EN 61009

| | | |
|--|----------------------------------|-------|
| Impulse current withstand (8/20 μs) without tripping | Types AC and A (non-selective ☒) | 250 Å |
| | Types AC and A (selective ☒) | 3 kÅ |
| | Types SI (non-selective ☒) | 3 kÅ |
| | Types SI (selective ☒) | 5 kÅ |

Additional characteristics

| | | |
|-----------------------|-------------------------------|------------------|
| Degree of protection | Device only | IP20 |
| | Device in a modular enclosure | IP40 |
| Operating temperature | Type AC | -5 °C to +60 °C |
| | Types A and SI | -25 °C to +60 °C |
| Storage temperature | | -40 °C to +85 °C |

Weight (g)

Add-on residual current devices

| Type | Vigi C120 |
|------|-----------|
| 2P | 325 |
| 3P | 500 |
| 4P | 580 |

Dimensions (mm)

C120 + Vigi C120

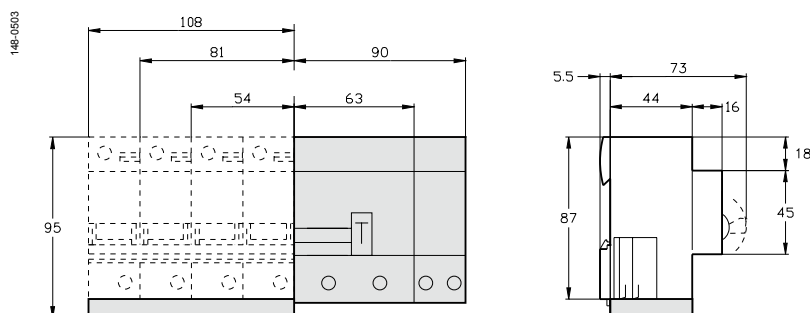

Vigi C120 add-on residual current devices (types AC, A and SI) (cont.)

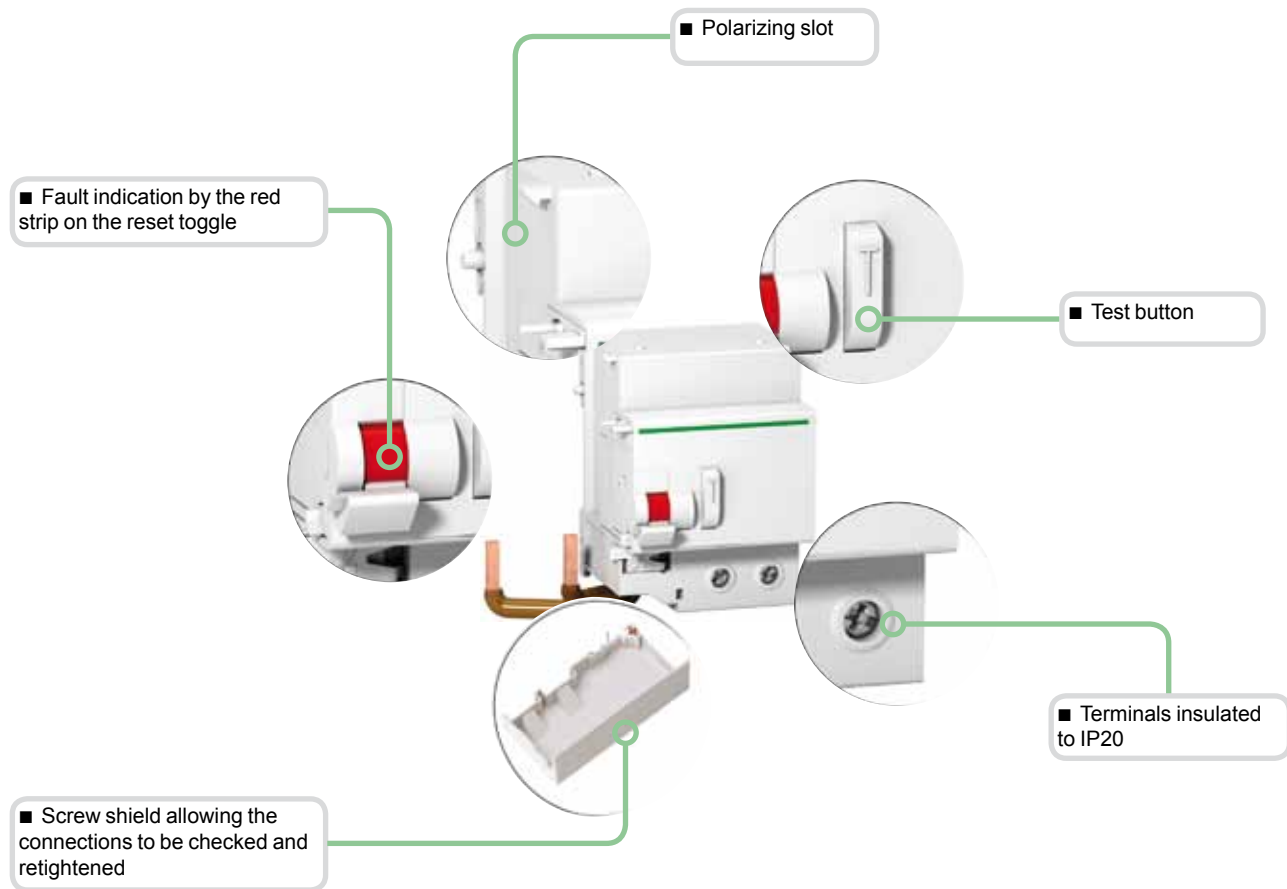

Type SI

The *SI* type provides increased immunity from electrical interference and polluted or corrosive environments.



Schneider Electric's range of add-on residual current devices consists of different products (A, B) to enable it to be the most competitive range possible in each country, allowing for the special characteristics of each market:

- usual installation procedure
- price
- accreditations by local bodies.

Variants

| Offers | | Pages |
|--------------|-------------------|-------|
| Offer A | Catalogue numbers | 205 |
| Offer B | Catalogue numbers | 208 |
| Common pages | | 211 |



Only the product range to be marketed in your country and validated by the local product manager, in agreement with his Final Distribution (FD) partner should be retained. The others will be removed before publication.

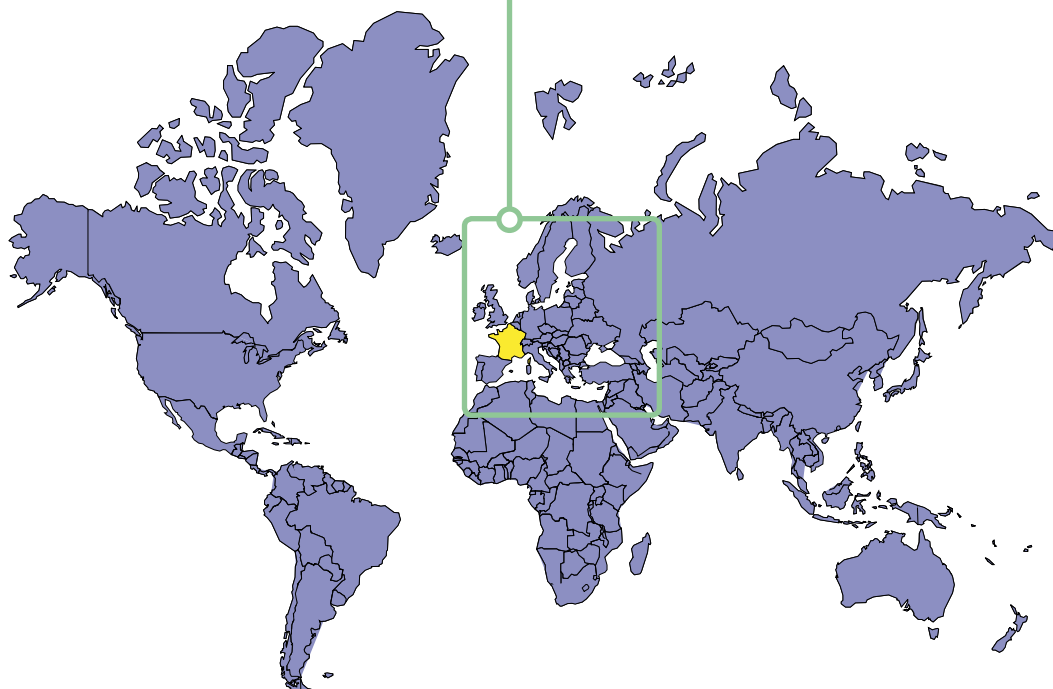

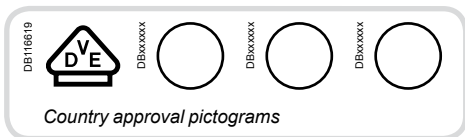

IEC/EN 60947-2

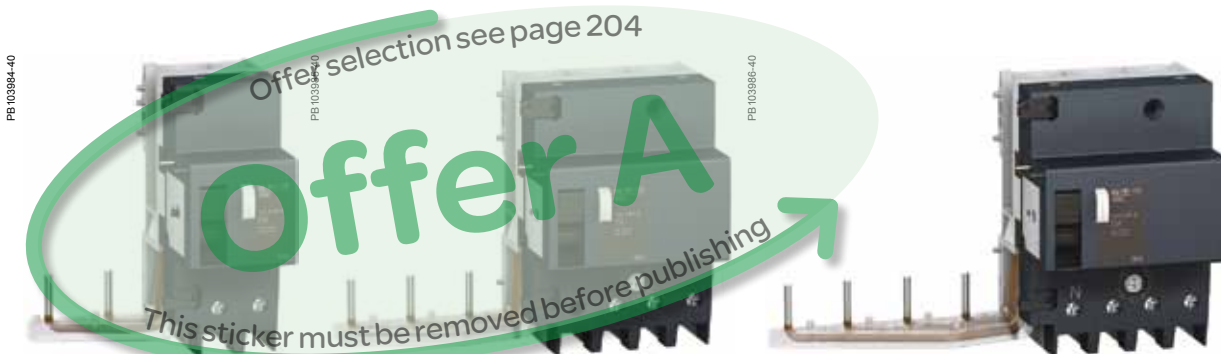

- When it is combined with an NG125 circuit breaker, the Vigi NG125 add-on residual current device offers the following functions:
 - protection of persons against electric shocks by direct contact (30 mA),
 - protection of persons against electric shocks by indirect contact (300 mA),
 - protection of installations against fire risks (300 mA).

Catalogue numbers

| Vigi NG125 add-on residual current devices | | | | | |
|--|----------------------------|--|--------------------------|------------------------|---|
| Type | AC | | Width in 9 mm modules | | |
| Product | Vigi NG125 | | | | |
| Auxiliaries | Without auxiliaries | | | | |
| 2P DB122462 | Sensitivity Rating 63 A | | 30 mA 19000 | 300 mA 19001 | 5 |
| 3P DB122463 | Sensitivity Rating 63 A | | 30 mA 19002 | 300 mA 19003 | 9 |
| 4P DB122464 | Sensitivity Rating 63 A | | 30 mA 19004 | 300 mA 19005 | 9 |
| Voltage rating (Ue) | | | 230 - 240 V, 400 - 415 V | | |
| Operating frequency | | | 50/60 Hz | | |
| Accessories | | | Module CM907006 | | |

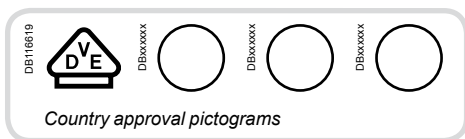







IEC/EN 60947-2

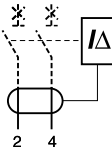

- When it is combined with an NG125 circuit breaker, the Vigi NG125 add-on residual current device offers the following functions:
 - protection of persons against electric shocks by direct contact (30 mA),
 - protection of persons against electric shocks by indirect contact (≥ 300 mA),
 - protection of installations against fire risks (300 mA or 500 mA).

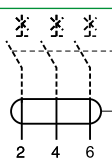
Catalogue numbers

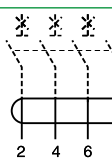
| Vigi NG125 add-on residual current devices | | | | | | | | |
|---|---|---------------------------|---------------------------|---|--|-----------------------|---------------------------|-----------------------|
| Type | A  | | | | | | | Width in 9 mm modules |
| Product | Vigi NG125 | | | | | | | |
| Auxiliaries | Module CM907005 | | | | | | | |
| 2P | Sensitivity | 30 mA | 300 mA | 300 mA  | 1000 mA  | 300...1000 I/S | 300...3000 I/S/R | |
|  | Rating 63 A | 19011 19008 (1) | 19012 19009 (1) | 19030 | 19031 | - | - | 5 |
| 3P | Sensitivity | 30 mA | 300 mA | 300 mA  | 1000 mA  | 300...1000 I/S | 300...3000 I/S/R | |
|  | Rating 63 A | 19013 | 19014 | 19032 | 19033 | - | - | 9 |
| | 125 A | 19039 19050 (2) | - | - | - | 19044 | 19036 19053 (2) | 11 |
| | | | | | | | 19047 19055 (2) | 11 |
| 4P | Sensitivity | 30 mA | 300 mA | 300 mA  | 1000 mA  | 300...1000 I/S | 300...3000 I/S/R | |
|  | Rating 63 A | 19017 | 19018 | 19034 | 19035 | - | - | 9 |
| | 125 A | 19041 19051 (2) | 19042 | - | - | 19045 | 19037 19054 (2) | 11 |
| | | | | | | | 19048 19056 (2) | 11 |
| Voltage rating (Ue) | 230 - 240 V, 400 - 415 V Except: (1) 110...220 V and (2) 440...500 V | | | | | | | |
| Operating frequency | 50/60 Hz | | | | | | | |
| Accessories | Module CM907006 | | | | | | | |

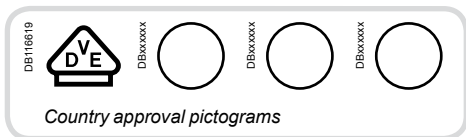

IEC/EN 60947-2

067484-140



■ When it is combined with an NG125 circuit breaker, the Vigi NG125 add-on residual current device offers the following functions:

- protection of persons against electric shocks by direct contact (30 mA),
- protection of persons against electric shocks by indirect contact (≥ 300 mA),
- protection of installations against fire risks (300 mA or 500 mA).

SI types are appropriate for operating in environments with:

- High risk of nuisance tripping: frequent lightning strikes, IT system, presence of electronic ballasts, frequency converters, presence of switchgear incorporating lighting type interference filters, computer system, etc.
- Blind sources
- presence of harmonics or high frequency rejections,
- presence of DC components: diodes, diode bridges, switch-mode power supplies, etc.
- Protected against nuisance tripping caused by transient voltage surges (lightning strike, operation of switchgear on the network, etc.).

Catalogue numbers

| Vigi NG125 add-on residual current devices | | | | | |
|--|-----------------|--------------------------|-----------------------|-------|----|
| Type | SI | | Width in 9 mm modules | | |
| Product | Vigi NG125 | | | | |
| Auxiliaries | Module CM907005 | | | | |
| 3P | Sensitivity | 30 mA | 300...3000 I/S/R | | |
| <p>DB122463</p> | Rating | 125 A | 19100 | 19106 | 11 |
| | | | | | |
| <p>DB122464</p> | Rating | 125 A | 19101 | 19107 | 11 |
| | | | | | |
| Voltage rating (Ue) | | 230 - 240 V, 400 - 415 V | | | |
| Operating frequency | | 50/60 Hz | | | |
| Accessories | | Module CM907006 | | | |

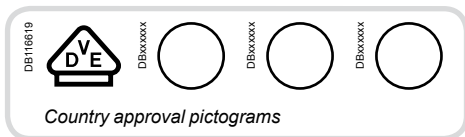

IEC/EN 60947-2

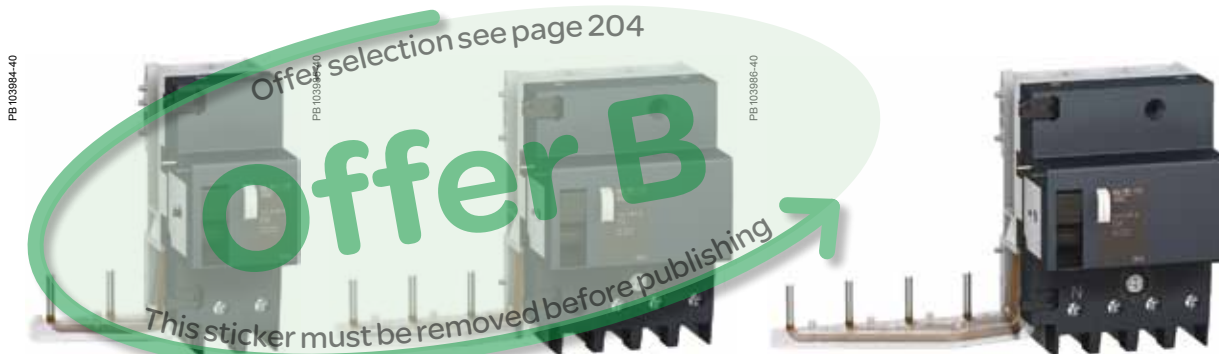

- When it is combined with an NG125 circuit breaker, the Vigi NG125 add-on residual current device offers the following functions:
 - protection of persons against electric shocks by direct contact (30 mA),
 - protection of persons against electric shocks by indirect contact (300 mA),
 - protection of installations against fire risks (300 mA).

Catalogue numbers

| Vigi NG125 add-on residual current devices | | | | | |
|--|---------------------|-------------|--------------------------|-----------------------|---|
| Type | AC | | | Width in 9 mm modules | |
| Product | Vigi NG125 | | | | |
| Auxiliaries | Without auxiliaries | | | | |
| 2P DB122462 | Rating | Sensitivity | 30 mA | 300 mA | 5 |
| | | 63 A | 19000 | 19001 | |
| 3P DB122463 | Rating | Sensitivity | 30 mA | 300 mA | 9 |
| | | 63 A | 19002 | 19003 | |
| 4P DB122464 | Rating | Sensitivity | 30 mA | 300 mA | 9 |
| | | 63 A | 19004 | 19005 | |
| Voltage rating (Ue) | | | 230 - 240 V, 400 - 415 V | | |
| Operating frequency | | | 50/60 Hz | | |
| Accessories | | | Module CM907006 | | |

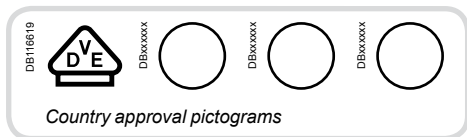

IEC/EN 60947-2



- When it is combined with an NG125 circuit breaker, the Vigi NG125 add-on residual current device offers the following functions:
 - protection of persons against electric shocks by direct contact (30 mA),
 - protection of persons against electric shocks by indirect contact (≥ 300 mA),
 - protection of installations against fire risks (300 mA or 500 mA).

Catalogue numbers

| Vigi NG125 add-on residual current devices | | | | | | | | |
|--|-----------------|---|--------------------|--------------------|---------|----------------|--------------------|-----------------------|
| Type | A | | | | | | | Width in 9 mm modules |
| Product | Vigi NG125 | | | | | | | |
| Auxiliaries | Module CM907005 | | | | | | | |
| 2P | Sensitivity | 30 mA | 300 mA | 300 mA | 1000 mA | 300...1000 I/S | 300...3000 I/S/R | |
| DB122462 | Rating | 63 A | 19010 19008 (1) | 19012 19009 (1) | 19030 | 19031 | - | 5 |
| | | | | | | | | |
| DB122463 | Rating | 63 A | 19013 | 19014 | 19032 | 19033 | - | 9 |
| | | | - | - | - | - | 19036 19053 (2) | 11 |
| | 125 A | 19039 | - | - | - | 19044 | 19047 19055 (2) | 11 |
| DB122464 | Rating | 63 A | 19015 | 19016 | 19034 | 19035 | - | 9 |
| | | | - | - | - | - | 19037 19054 (2) | 11 |
| | 125 A | 19041 | 19042 | - | - | 19046 | 19049 19056 (2) | 11 |
| Voltage rating (Ue) | | 230 - 240 V, 400 - 415 V Except: (1) 110...220 V and (2) 440...500 V | | | | | | |
| Operating frequency | | 50/60 Hz | | | | | | |
| Accessories | | Module CM907006 | | | | | | |

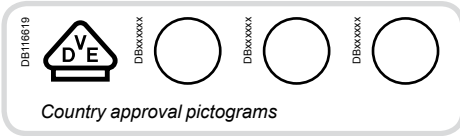

IEC/EN 60947-2

067484-40



■ When it is combined with an NG125 circuit breaker, the Vigi NG125 add-on residual current device offers the following functions:

- protection of persons against electric shocks by direct contact (30 mA),
- protection of persons against electric shocks by indirect contact (≥ 300 mA),
- protection of installations against fire risks (300 mA or 500 mA).

SI types are appropriate for operating in environments with:

- High risk of nuisance tripping: frequent lightning strikes, IT system, presence of electronic ballasts, frequency converters, presence of switchgear incorporating lighting type interference filters, computer system, etc.
- Blind sources
- presence of harmonics or high frequency rejections,
- presence of DC components: diodes, diode bridges, switch-mode power supplies, etc.
- Protected against nuisance tripping caused by transient voltage surges (lightning strike, operation of switchgear on the network, etc.).

Catalogue numbers

| Vigi NG125 add-on residual current devices | | | | | |
|--|--------------------|--------------|--------------------------|--------------|-----------------------|
| Type | SI | | Vigi NG125 | | Width in 9 mm modules |
| Product | Module CM907005 | | | | |
| Auxiliaries | Module CM907005 | | | | |
| 3P | Sensitivity | 30 mA | 300...3000 I/S/R | | |
| | Rating | 125 A | 19100 | 19106 | 11 |
| 4P | Sensitivity | 30 mA | 300...3000 I/S/R | | |
| | Rating | 125 A | 19101 | 19107 | 11 |
| Voltage rating (Ue) | | | 230 - 240 V, 400 - 415 V | | |
| Operating frequency | | | 50/60 Hz | | |
| Accessories | | | Module CM907006 | | |

Connection

| DB123404 | | Rating Tightening torque | Without accessories | | | With accessories | | |
|----------|--|---|---------------------|-------------------------|-------------------------|--------------------------------|---------------------------------------|--------------|
| | | | Copper cables | | | 70 mm ² Al terminal | Screw-on connection for ring terminal | |
| | | | Rigid | Flexible or ferrule | Screw clamp terminal | | | |
| DB123405 | | 63 A 125 A | 3.5 N.m 6 N.m | DB123405 | DB123406 | DB123409 | DB123410 | DB123488 |
| DB123408 | | Pre-alarm | 1 N.m | 2 x 2.5 mm ² | 2 x 1.5 mm ² | 2 x 1.5 mm ² | - | - |

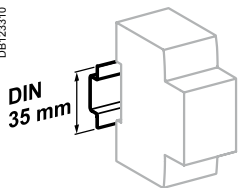

Clip on DIN rail 35 mm.

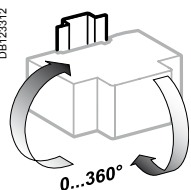

Indifferent position of installation.

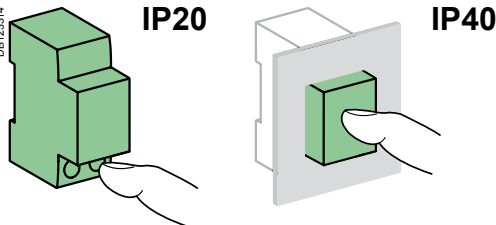

Technical data

| Main characteristics | | |
|--|---|---|
| Insulation voltage (U _i) | | 690 V |
| Pollution degree | | 3 |
| Rated impulse withstand voltage (U _{imp}) | | 8 kV |
| According to IEC/EN 61009-1 | | |
| Surge current withstand (8/20 μs) without tripping | Selective <input type="checkbox"/> or R | 5 kA |
| | Instantaneous | 3 kA |
| Additional characteristics | | |
| Degree of protection | Device only | IP20 |
| | Device in modular enclosure | IP40 |
| Operating temperature | AC type | -5°C to +60°C |
| | A and S/I types | -25°C to +60°C |
| Storage temperature | | -40°C to +85°C |
| Additional characteristics | | |
| Vigi 125 A and adjustable | | |
| Plug-in auxiliaries | MXV | Remote tripping |
| | SDV | Indication of tripping upon earth fault |
| Adjustable Vigi | | |
| Sensitivity adjustable by notch (IΔn) | | 300, 500, 1000, 3000 mA |
| Tripping time | Instantaneous | |
| | Selective <input type="checkbox"/> | 60 ms |
| | Time-delayed | 150 ms |
| Leakage current indication on 3P and 4P 300...3000 I/S/R (pre-alarm) | | On front face by LED |
| | | Remote, by potential-free normally-open contact 250 V - 1 A (low level) |
| | | Threshold setting by potentiometer from 10 % to 50 % of IΔn |
| Disconnection essential for dielectric test | | By integral pushbutton |

Vigi NG125 add-on residual current devices (AC, A, S/I types) (cont.)

Weight (g)

| Add-on residual current devices | | | |
|---------------------------------|-----|-----|-----|
| Number of 9 mm modules | 2P | 3P | 4P |
| 5 modules | 250 | - | - |
| 9 modules | - | 410 | 450 |
| 11 modules | - | 750 | 800 |

Dimensions (mm)

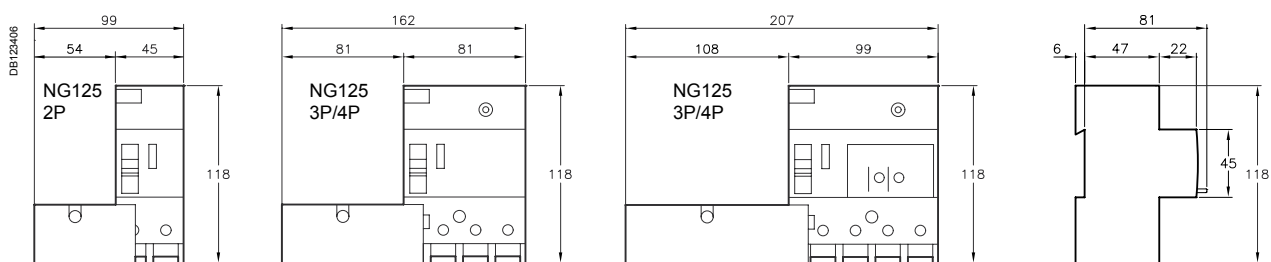

2P (5 modules)

63, 125 A (9 modules)

63, 125 A (11 modules)

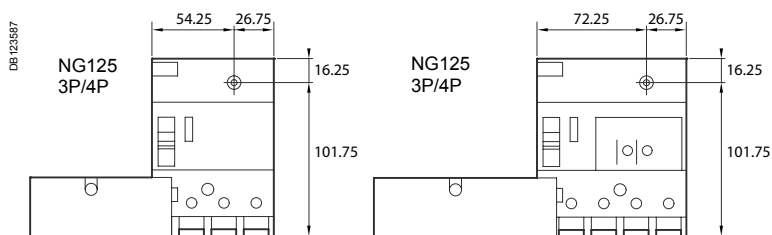

Spacing for mounting on panel

Vigi NG125 add-on residual current devices (AC, A, *SI* types) (cont.)

068341_SE-90



Association NG125 + Vigi NG125

| | Vigi NG125 63 A | Vigi NG125 125 A |
|-------------------|--------------------|---------------------|
| NG125 ≤ 63 A | ■ | NO |
| NG125 80...125 A* | NO | ■ |

(*) No Vigi add-on residual current device for 2P circuit breakers of rating 80 A.

PB104468-40

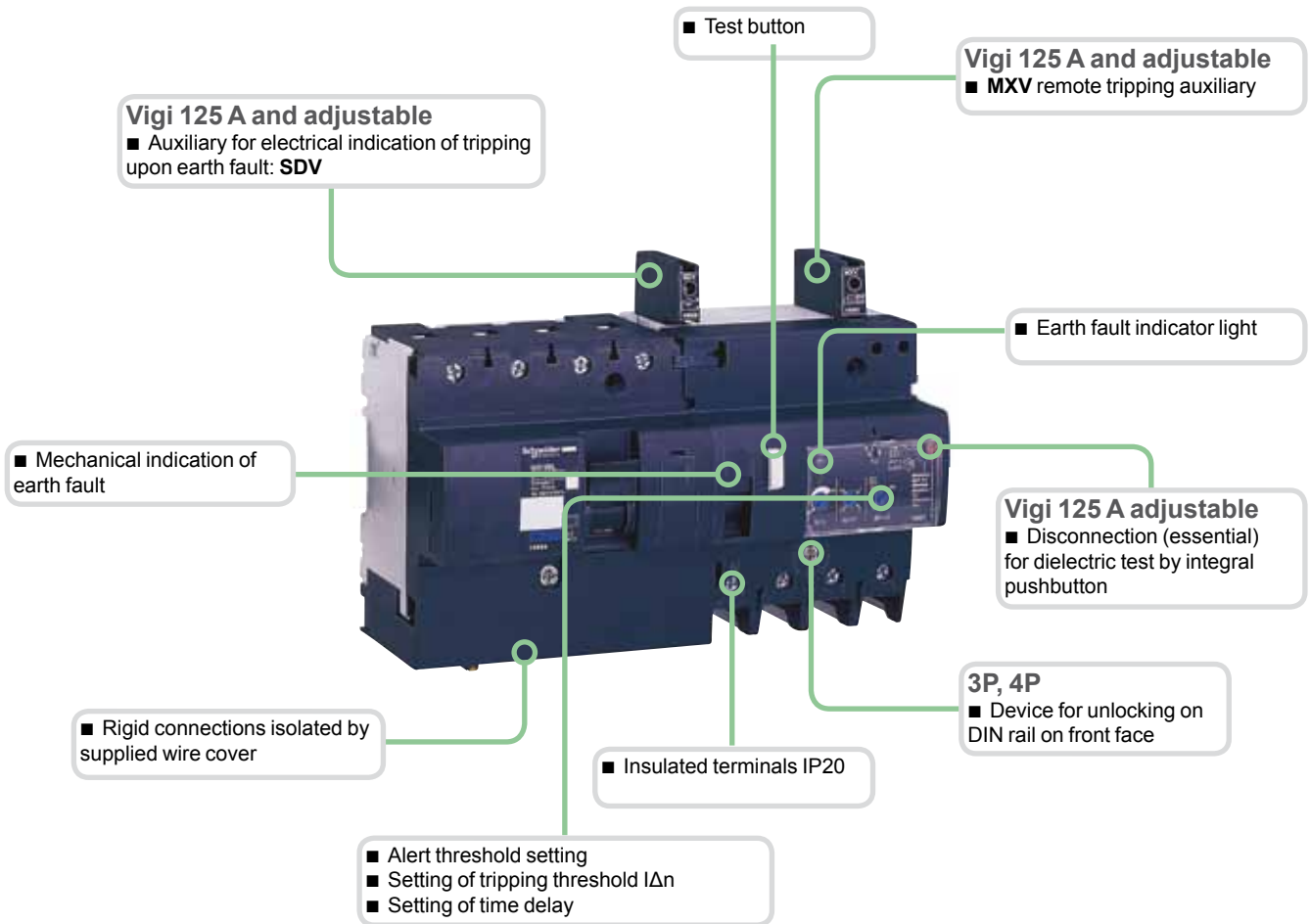

SI type

SI types are appropriate for operating in environments with:

- High risk of nuisance tripping: frequent lightning strikes, IT system, presence of electronic ballasts, frequency converters, presence of switchgear incorporating lighting type interference filters, computer system, etc.
- Blind sources
 - presence of harmonics or high frequency rejections,
 - presence of DC components: diodes, diode bridges, switch-mode power supplies, etc.
- Protected against nuisance tripping caused by transient voltage surges (lightning strike, operation of switchgear on the network, etc.).



IEC/EN 61009



iDPNa Vigi

iDPN H Vigi

■ The iDPN Vigi residual current device provide complete protection for final circuits (against overcurrents and insulation faults):

- protection for users against electric shocks by direct contacts (≤ 30 mA),
- protection for users against electric shocks by indirect contacts (300 mA),
- protection of the installations against fire risks (300 mA).

■ The *SI* range has been designed to maintain a network with optimum safety and continuity of service in installations disturbed by:

- extreme atmospheric conditions,
- harmonic generating loads,
- transient operating currents.

Catalogue numbers

iDPNa Vigi 4500



| Type | | AC | A | | | | Width in 9 mm modules |
|---------------------|-------------|--|----------|----------|----------|----------|-----------------------|
| Auxiliaries | | Remote tripping and indication, module CA907000 and CA907002 | | | | | |
| 1P+N | Curve B | Sensitivity | 30 mA | 300 mA | 10 mA | 30 mA | |
| | Rating (In) | 6 A | A9D51606 | - | - | A9D54606 | 4 |
| | | 10 A | A9D51610 | - | - | A9D54610 | |
| | | 13 A | - | - | - | A9D54613 | |
| | | 16 A | A9D51616 | - | - | A9D54616 | |
| | | 20 A | A9D51620 | - | - | A9D54620 | |
| | | 25 A | A9D51625 | - | - | A9D54625 | |
| | | 32 A | A9D51632 | - | - | A9D54632 | |
| | | 40 A | A9D51640 | - | - | A9D54640 | |
| | Rating (In) | 6 A | A9D34606 | A9D44606 | - | A9D35606 | 4 |
| | | 10 A | A9D34610 | A9D44610 | A9D05610 | A9D35610 | |
| | | 13 A | - | - | - | A9D35613 | |
| | | 16 A | A9D34616 | A9D44616 | A9D05616 | A9D35616 | |
| | | 20 A | A9D34620 | A9D44620 | - | A9D35620 | |
| | | 25 A | A9D34625 | A9D44625 | - | A9D35625 | |
| | | 32 A | A9D34632 | A9D44632 | - | A9D35632 | |
| | | 40 A | A9D34640 | A9D44640 | - | A9D35640 | |
| Voltage rating (Ue) | | 230 V AC | | | | | |
| Operating frequency | | 50 Hz | | | | | |
| Accessories | | Module CA907000 and CA907001, comb busbars LIN001 | | | | | |





iDPN N Vigi

iDPN N Vigi G Type 6000

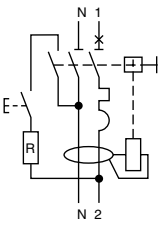
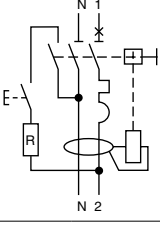
| Type | | AC | A | | Width in 9 mm modules |
|---------------------|-------------|--|----------|----------|-----------------------|
| Auxiliaries | | Remote tripping and indication, module CA907000 and CA907002 | | | |
| 1P+N | Curve C | Sensitivity | 30 mA | 100 mA | |
| | Rating (In) | 6 A | A9D62606 | A9D72606 | 4 |
| | | 10 A | A9D62610 | A9D72610 | |
| | | 13 A | A9D62613 | A9D72613 | |
| | | 16 A | A9D62616 | A9D72616 | |
| Voltage rating (Ue) | | 230 V AC | | | |
| Operating frequency | | 50 Hz | | | |
| Accessories | | Module CA907000 and CA907001, comb busbars LIN001 | | | |

| iDPN N Vigi 6000 | | | | | | | | | | | | |
|---|-------------|--|----------|----------|---|----------|----------|--|----------|----------|-----------------------|---|
| Type | | AC  | | | A  | | | SI  | | | Width in 9 mm modules | |
| Auxiliaries | | Remote tripping and indication, module CA907000 and CA907002 | | | | | | | | | | |
| 1P+N Curve B | | Sensitivity | 30 mA | 300 mA | 10 mA | 30 mA | 100 mA | 300 mA | 30 mA | 100 mA | 300 mA | |
|  | Rating (In) | 4 A | A9D55604 | A9D68604 | - | A9D56604 | A9D60604 | A9D69604 | - | - | - | 4 |
| | | 6 A | A9D55606 | A9D68606 | - | A9D56606 | A9D60606 | A9D69606 | - | - | - | |
| | | 10 A | A9D55610 | A9D68610 | A9D08610 | A9D56610 | A9D60610 | A9D69610 | - | - | - | |
| | | 13 A | - | - | - | A9D56613 | A9D60613 | A9D69613 | - | - | - | |
| | | 16 A | A9D55616 | A9D68616 | A9D08616 | A9D56616 | A9D60616 | A9D69616 | - | - | - | |
| | | 20 A | A9D55620 | A9D68620 | - | A9D56620 | A9D60620 | A9D69620 | - | - | - | |
| | | 25 A | A9D55625 | A9D68625 | - | A9D56625 | A9D60625 | A9D69625 | - | - | - | |
| | | 32 A | A9D55632 | A9D68632 | - | A9D56632 | A9D60632 | A9D69632 | - | - | - | |
| 40 A | A9D55640 | A9D68640 | - | A9D56640 | A9D60640 | A9D69640 | - | - | - | | | |
|  | Rating (In) | 6 A | A9D31606 | A9D41606 | - | A9D32606 | A9D52606 | A9D42606 | A9D33606 | A9D53606 | A9D43606 | 4 |
| | | 10 A | A9D31610 | A9D41610 | A9D02610 | A9D32610 | A9D52610 | A9D42610 | A9D33610 | A9D53610 | A9D43610 | |
| | | 13 A | - | - | - | A9D32613 | A9D52613 | A9D42613 | A9D33613 | A9D53613 | A9D43613 | |
| | | 16 A | A9D31616 | A9D41616 | A9D02616 | A9D32616 | A9D52616 | A9D42616 | A9D33616 | A9D53616 | A9D43616 | |
| | | 20 A | A9D31620 | A9D41620 | - | A9D32620 | A9D52620 | A9D42620 | A9D33620 | A9D53620 | A9D43620 | |
| | | 25 A | A9D31625 | A9D41625 | - | A9D32625 | A9D52625 | A9D42625 | A9D33625 | A9D53625 | A9D43625 | |
| | | 32 A | A9D31632 | A9D41632 | - | A9D32632 | A9D52632 | A9D42632 | A9D33632 | A9D53632 | A9D43632 | |
| | | 40 A | A9D31640 | A9D41640 | - | A9D32640 | A9D52640 | A9D42640 | A9D33640 | A9D53640 | A9D43640 | |
| Voltage rating (Ue) | | 230 V AC | | | | | | | | | | |
| Operating frequency | | 50 Hz | | | | | | | | | | |
| Accessories | | Module CA907000 and CA907001, comb busbars LIN001 | | | | | | | | | | |

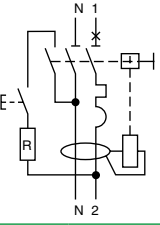
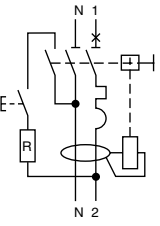
| iDPN H Vigi 10000 | | | | | | | | | | | | |
|---|-------------|---|----------|----------|--|----------|---|-----------------------|--|--|--|--|
| Type | | A  | | | SI  | | | Width in 9 mm modules | | | | |
| Auxiliaries | | Remote tripping and indication, module CA907000 and CA907002 | | | | | | | | | | |
| 1P+N Curve B | | Sensitivity | 30 mA | 300 mA | 30 mA | 300 mA | | | | | | |
|  | Rating (In) | 6 A | A9D07606 | - | - | - | 4 | | | | | |
| | | 10 A | A9D07610 | - | - | - | | | | | | |
| | | 16 A | A9D07616 | - | - | - | | | | | | |
| | | 20 A | A9D07620 | - | - | - | | | | | | |
| | | 25 A | A9D07625 | - | - | - | | | | | | |
| | | 32 A | A9D07632 | - | - | - | | | | | | |
|  | Rating (In) | 6 A | A9D37606 | A9D47606 | A9D38606 | A9D48606 | 4 | | | | | |
| | | 10 A | A9D37610 | A9D47610 | A9D38610 | A9D48610 | | | | | | |
| | | 16 A | A9D37616 | A9D47616 | A9D38616 | A9D48616 | | | | | | |
| | | 20 A | A9D37620 | A9D47620 | A9D38620 | A9D48620 | | | | | | |
| | | 25 A | A9D37625 | A9D47625 | A9D38625 | A9D48625 | | | | | | |
| | | 32 A | A9D37632 | A9D47632 | A9D38632 | A9D48632 | | | | | | |
| Voltage rating (Ue) | | 230 V AC | | | | | | | | | | |
| Operating frequency | | 50 Hz | | | | | | | | | | |
| Accessories | | Module CA907000 and CA907001, comb busbars LIN001 | | | | | | | | | | |

DB405964-40

■ Fast contact closure

■ Insulated terminals IP20

Visi-trip double window

- Fault tripping circuit breaker is indicated by a red mechanical indicator on the front face.
- Earth fault is indicated by a red mechanical indicator on the front face

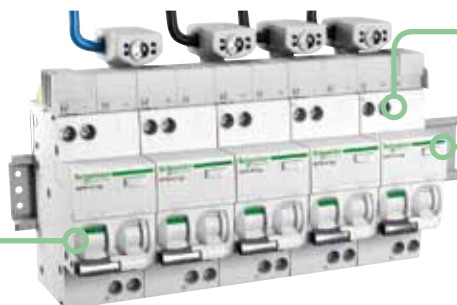

■ Test button

Positive contact indication

- A green strip on the toggle guarantees opening of all the poles in safety conditions (padlocking possible) for work to be carried out on live parts

DB123310

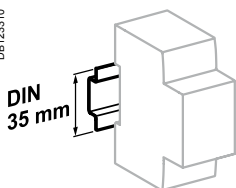

Clip on DIN rail 35 mm.

DB123312

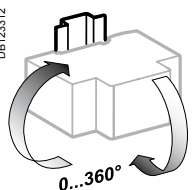

Indifferent position of installation.

DB123314

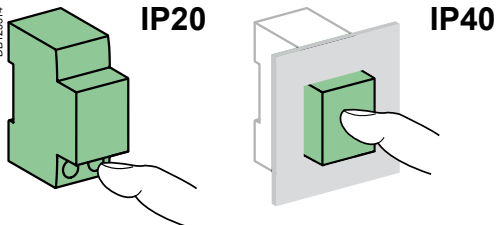

Weight (g)

Residual current device

| Type | iDPN Vigi |
|------|-----------|
| 1P+N | 125 |

Dimensions (mm)

DB124454

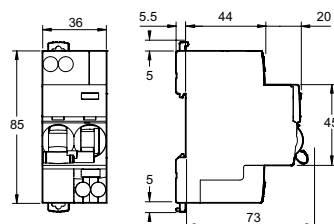

Connection

DB123947

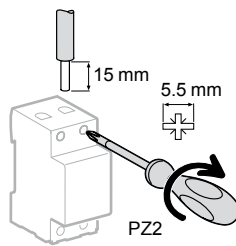

| Rating | Tightening torque | Copper cables | |
|-----------|-------------------|-------------------------------------|-------------------------------------|
| | | Rigid | Flexible or ferrule |
| 4 to 40 A | 2 N.m | DB122845 1 to 16 mm ² | DB122846 1 to 10 mm ² |

Technical data

| Main characteristics | | | |
|--|--|---------------------------------|---------------|
| Type | iDPNa Vigi | iDPN N Vigi | iDPN H Vigi |
| Insulation voltage (U _i) | 400 V AC | | |
| Pollution degree | 3 | | |
| Rated impulse withstand voltage (U _{imp}) | 4 kV | | |
| Setting temperature for ratings | 30°C | | |
| Magnetic tripping | Curve B | Between 3 and 5 I _n | |
| | Curve C | Between 5 and 10 I _n | |
| According to EN 61009 | | | |
| Limitation class | 3 | | |
| Rated breaking capacity (I _{cn}) | 4500 A | 6000 A | 10,000 A |
| Rated residual breaking and making capacity (I _{Δm}) | 4500 A | 6000 A | 10,000 A |
| 8/20 μs impulse withstand | Type AC | 250 Å | 250 Å |
| | Type A | 250 Å | 250 Å |
| | Type SI | - | 3 kÅ |
| 3 kÅ | - | 3 kÅ | |
| Additional characteristics | | | |
| Earth leakage protection with instantaneous tripping | 10, 30, 300 mA | 10, 30, 100, 300 mA | 30, 300 mA |
| Degree of protection (IEC 60529) | Device only | IP20 | |
| | Device in modular enclosure | IP40 | |
| Endurance (O-C) | Electrical | ≤ 20 A | 20,000 cycles |
| | | ≥ 25 A | 10,000 cycles |
| | Mechanical | 20,000 cycles | |
| Overvoltage category (IEC 60364) | III | | |
| Operating temperature | Type AC | -5°C to +60°C | |
| | Type A, SI | -25°C to +60°C | |
| Storage temperature | -40°C to +85°C | | |
| Tropicalization (IEC 60068-1) | Treatment 2 (relative humidity 95 % to 55°C) | | |



The Schneider Electric residual current device range comprises various offers (Clario, Prodis, Libro) so as to be as competitive as possible in each country, taking into account the specific features of each market:

- installation customs
- price
- approval by local organizations.

Variants

| Offers | | Pages |
|--------------|-------------------|-------|
| Common pages | | 218 |
| Clario | Catalogue numbers | 219 |
| Prodis | Catalogue numbers | 221 |
| Librio | Catalogue numbers | 223 |
| Common pages | | 225 |

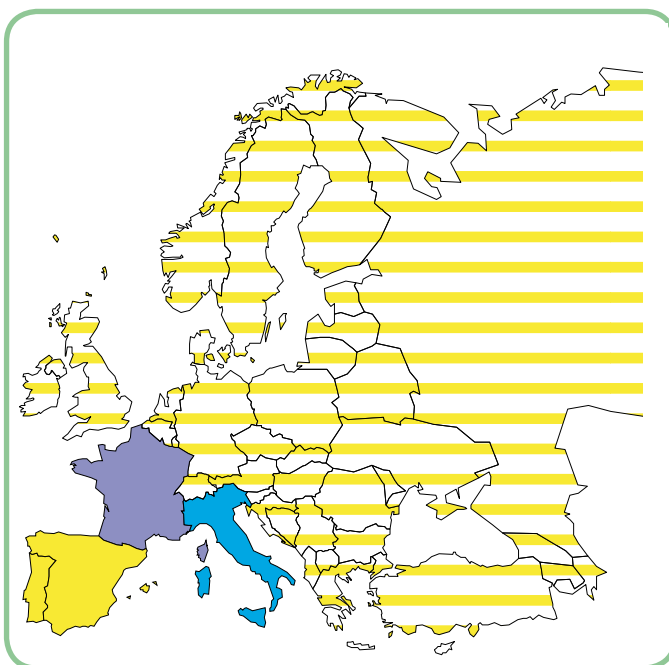

Only the product range to be marketed in your country and validated by the local product manager, in agreement with his Final Distribution (FD) partner should be retained. The others will be removed before publication.

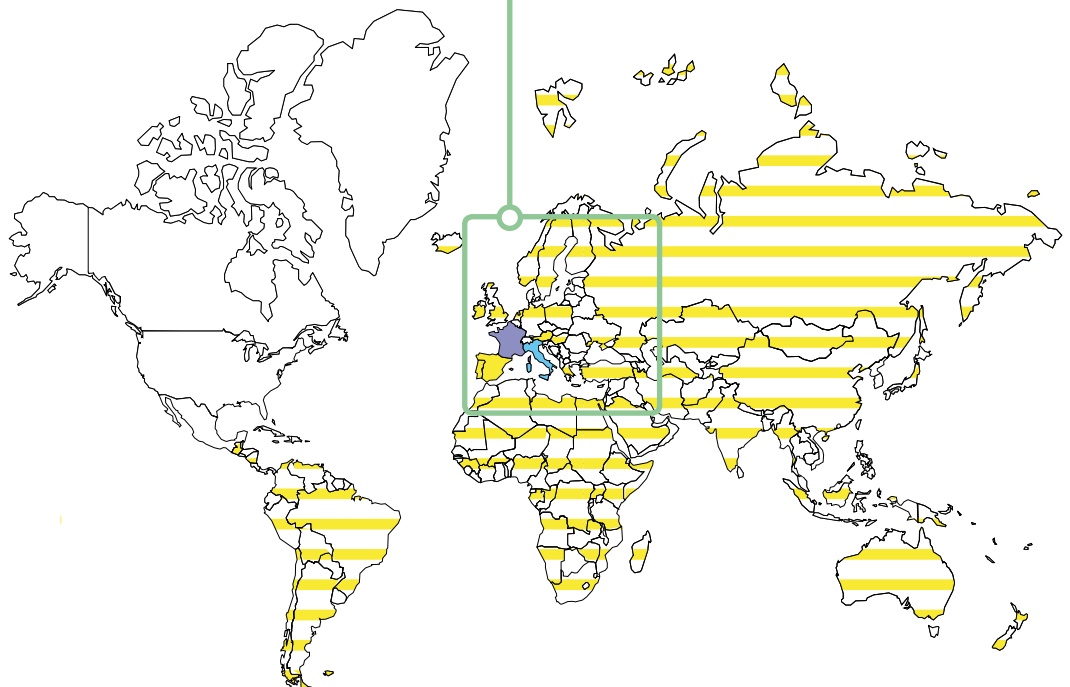

Adapted to the needs of service sector and industrial building installations, earth leakage protection devices can ensure:

- protection of electrical installations against insulation faults
- protection for people against direct and indirect contact
- protection of the installations against fire risks.

The range of earth leakage modules adaptable to the circuit breakers consists of:

- Vigi modules for protection of "outgoers"
- Vigi modules for protection of "Group Feeders".

"Outgoer" and "Group Feeder" residual current devices are also available in "monobloc" version.

The Vigi modules, to be combined with or already combined with a circuit breaker, incorporate in a single enclosure the residual current relay and the toroid.

- The residual current tripping device is electromechanical and operates without an auxiliary source.
- A homogeneous unit in compliance with the EN 61009-1 and EN 61009-2-1 standards, a residual current device retains all the characteristics of the circuit breaker alone; in particular, the thermal tripping threshold of the circuit breaker is retained in the presence of the earth leakage module.

Operation

- When an earth fault occurs, the Vigi module causes automatic opening of the circuit breaker with which it is combined. Fault indication is performed by a red strip on the operating handle for Vigi module resetting.
- Resetting of the earth leakage module is performed, at the user's choice:
 - either by the reset handle of the circuit breaker (in one operation),
 - or independently of the circuit breaker (in 2 operations).

Earth leakage protection is provided:

- either by earth leakage modules adaptable to circuit breakers
- or by monobloc residual current devices.



Earth leakage protection

"Group Feeder"



"Outgoers"



Monobloc

"Group Feeder"



"Outgoers"



Add-on modules

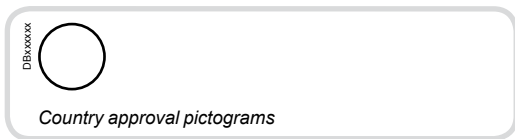

IEC/EN 61009-1 and 61009-2-1

Earth leakage protection for "Group Feeders" is performed:
 ■ either by a monobloc residual current device
 ■ or by a circuit breaker combined with a Vigi module.



Catalogue numbers

| i DPN Vigi residual current devices 4500 EN 61009 - C curve | | | | | | |
|---|---|--------------|---------------|----------------|----------|-----------------------|
| Type | AC | | | | | Width in 9-mm modules |
| Auxiliaries | Add-on auxiliaries: see modules CA907008 and CA907010 | | | | | |
| 3P+N | Sensitivity | 30 mA | 300 mA | 300 mA | | |
| | Rating | 25 A | A9N21771 | A9N21775 | A9N21772 | 12 |
| | | 40 A | A9N21773 | A9N21776 | A9N21774 | |



Catalogue numbers

| "Group Feeder" i DPN Vigi modules | | | | | | | | | | | |
|-----------------------------------|--------------------|--------------|---------------|-------------------|--------------|-------------------|--------------|---------------|-----------------------|----------|--|
| Type | AC | | | A | | SI | | | Width in 9-mm modules | | |
| Auxiliaries | Without auxiliary | | | Without auxiliary | | Without auxiliary | | | | | |
| 1P+N | Sensitivity | 30 mA | 300 mA | 300 mA | 30 mA | 300 mA | 30 mA | 300 mA | 300 mA | | |
| | Rating | 25 A | A9N21741 | A9N21742 | - | A9N21745 | A9N21746 | A9N21749 | A9N21750 | - | |
| | | 40 A | A9N21743 | A9N21744 | - | A9N21747 | A9N21748 | A9N21751 | A9N21752 | A9N21753 | |
| 3P+N | Sensitivity | 30 mA | 300 mA | 300 mA | 30 mA | 300 mA | 30 mA | 300 mA | 300 mA | | |
| | Rating | 25 A | A9N21755 | A9N21756 | - | A9N21759 | A9N21760 | A9N21763 | A9N21764 | - | |
| | | 40 A | A9N21757 | A9N21758 | - | A9N21761 | A9N21762 | A9N21765 | A9N21766 | A9N21767 | |
| | | 63 A | A9N26846 | A9N26847 | A9N26848 | - | - | A9N26849 | - | - | |

Vigi modules and residual current devices *i*DPN "Outgoer"

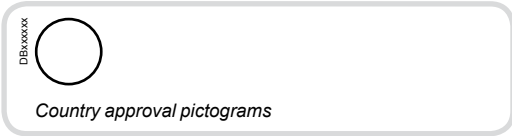

IEC/EN 61009-1 and 61009-2-1

For the earth leakage protection of "outgoers", a residual current device is built by combining a circuit breaker and a Vigi module. "Outgoer" residual current devices are also available in monobloc version.

Catalogue numbers

| <i>i</i> DPN Vigi residual current devices 4500 EN 61009 - C curve | | | | |
|--|---|-------|----------|-----------------------|
| Type | AC | | | Width in 9-mm modules |
| Auxiliaries | Add-on auxiliaries: see modules CA907008 and CA907010 | | | |
| 1P+N | Sensitivity | 30 mA | 300 mA | |
| | Rating | 6 A | A9N21614 | A9N21624 |
| | | 10 A | A9N21615 | A9N21625 |
| | | 16 A | A9N21616 | A9N21626 |
| | | 20 A | A9N21617 | A9N21627 |
| | | 25 A | A9N21618 | A9N21628 |
| | | 32 A | A9N21619 | A9N21629 |
| | | 40 A | A9N21620 | A9N21630 |



Offer selection see page 217

Clarío

This sticker must be removed before publishing

Catalogue numbers

| "Outgoer" <i>i</i> DPN Vigi modules | | | | | | | | | |
|-------------------------------------|-------------|-------|----------|----------|----------|----------|----------|-----------------------|----------|
| Type | AC | | | A | | SI | | Width in 9-mm modules | |
| 1P+N | Sensitivity | 30 mA | 100 mA | 300 mA | 30 mA | 300 mA | 30 mA | 300 mA | |
| | Rating | 25 A | A9N21681 | A9N21678 | A9N21682 | A9N21685 | A9N21686 | A9N21689 | A9N21690 |
| | | | A9N21680 | A9N21679 | Type G | | | | |
| | | 40 A | A9N21683 | - | A9N21684 | A9N21687 | A9N21688 | A9N21691 | A9N21692 |
| | Rating | 25 A | A9N21695 | - | A9N26696 | A9N21699 | A9N21700 | A9N21703 | A9N21704 |
| | | 40 A | A9N21697 | - | A9N26698 | A9N21701 | A9N21702 | A9N21705 | A9N21706 |
| | | | | | | | | | |
| | Rating | 25 A | A9N21709 | - | A9N21710 | A9N21713 | A9N21714 | A9N21717 | A9N21718 |
| | | 40 A | A9N21711 | - | A9N21712 | A9N21715 | A9N21716 | A9N21719 | A9N21720 |
| | | | | | | | | | |

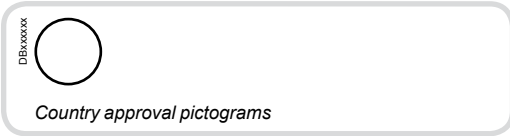

IEC/EN 61009-1 and 61009-2-1

Earth leakage protection for "Group Feeders" is performed by a circuit breaker combined with a Vigi module.



Catalogue numbers

| "Group Feeder" TG40 Vigi modules | | | | | | | |
|----------------------------------|--------|--------------------|----------|-------------------|----------|----------|-----------------------|
| Type | | AC | SI | | | | Width in 9-mm modules |
| Auxiliaries | | Without auxiliary | | Without auxiliary | | | |
| DB123669 | | Sensitivity | 30 mA | 300 mA | 30 mA | 300 mA | 300 mA |
| | Rating | 25 A | A9N21480 | A9N21481 | A9N21484 | A9N21485 | - |
| | 40 A | A9N21482 | A9N21483 | A9N21486 | A9N21487 | A9N21489 | |
| DB123671 | | Sensitivity | 30 mA | 300 mA | 30 mA | 300 mA | 300 mA |
| | Rating | 25 A | A9N21490 | A9N21491 | A9N21494 | A9N21495 | - |
| | 40 A | A9N21492 | A9N21493 | A9N21496 | A9N21497 | A9N21499 | |
| "Group Feeder" TG60 Vigi modules | | | | | | | |
| Type | | AC | SI | | | | Width in 9-mm modules |
| Auxiliaries | | Without auxiliary | | Without auxiliary | | | |
| DB123639 | | Sensitivity | 30 mA | 300 mA | 30 mA | 300 mA | 300 mA |
| | Rating | 40 A | A9N21511 | A9N21512 | A9N21513 | A9N21514 | A9N21518 |
| | 63 A | A9N21562 | A9N21563 | A9N21564 | A9N21572 | A9N21573 | |

Vigi modules and residual current devices DT40 "Outgoer"

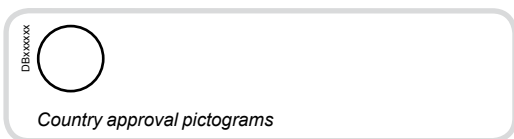

IEC/EN 61009-1 and 61009-2-1

For the earth leakage protection of "outgoers", a residual current device is built by combining a circuit breaker and a Vigi module. "Outgoer" residual current devices are also available in monobloc version.

Catalogue numbers

| DT40 Vigi residual current devices 4500 EN 61009 - C curve | | | | | | |
|--|---|----------|-----------------------|---|--|--|
| Type | AC | | Width in 9-mm modules | | | |
| Auxiliaries | Add-on auxiliaries: see modules CA907008 and CA907010 | | | | | |
| 1P+N | Sensitivity | 30 mA | 300 mA | | | |
| Rating | 10 A | A9N21442 | A9N21443 | 4 | | |
| | 16 A | A9N21444 | A9N21445 | | | |

PB107176-32



PB107176-32



Offer selection see page 217
Prodis
This sticker must be removed before publishing

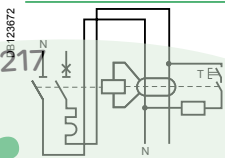

Catalogue numbers

| "Outgoer" DT40 Vigi modules | | | | | | |
|-----------------------------|-------------|-------|----------|----------|-----------------------|----------|
| Type | AC | | SI | | Width in 9-mm modules | |
| 1P+N | Sensitivity | 30 mA | 300 mA | 30 mA | 300 mA | 2 |
| | Rating | 25 A | A9N21450 | A9N21451 | A9N21454 | |
| 3P | Sensitivity | 30 mA | 300 mA | 30 mA | 300 mA | 4 |
| | Rating | 25 A | A9N21460 | A9N26461 | A9N21464 | |
| 3P+N | Sensitivity | 30 mA | 300 mA | 30 mA | 300 mA | 4 |
| | Rating | 25 A | A9N21470 | A9N21471 | A9N21474 | |
| | | 40 A | A9N21472 | A9N21473 | A9N21476 | A9N21477 |

DB123689

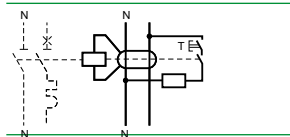

DB123670

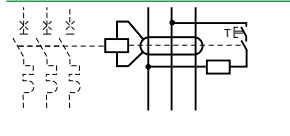

DB123671

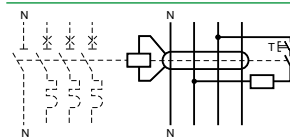

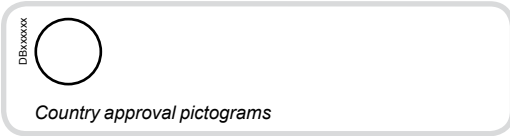

IEC/EN 61009-1 and 61009-2-1

Earth leakage protection for "Group Feeders" is performed by a circuit breaker combined with a Vigi module.



Catalogue numbers

"Group Feeder" C40 Vigi modules

| Type | | AC | A | S/ | Width in 9-mm modules | | | |
|--|-------------|----------|----------|----------|-----------------------|----------|----------|----------|
| 1P+N <small>DB123689</small> | Sensitivity | 30 mA | 300 mA | 30 mA | 300 mA | 2 | | |
| | Rating | 25 A | A9N19470 | A9N19471 | A9N19480 | | A9N19481 | A9N19490 |
| 3P+N <small>DB123671</small> | Sensitivity | 30 mA | 300 mA | 30 mA | 300 mA | 30 mA | 300 mA | 6 |
| | Rating | 25 A | A9N19472 | A9N19473 | A9N19482 | A9N19483 | A9N19492 | |
| | 40 A | A9N19474 | A9N19475 | A9N19484 | A9N19485 | A9N19494 | A9N19499 | |
| | | | | | | | | |
| | | | | | | | | |
| | | | | | | | | |
| | | | | | | | | |

Vigi modules and residual current devices C40 "Outgoer"

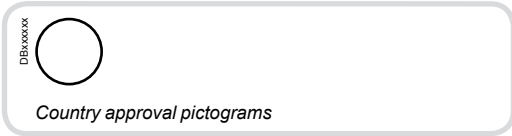

IEC/EN 61009-1 and 61009-2-1

For the earth leakage protection of "outgoers", a residual current device is built by combining a circuit breaker and a Vigi module.
"Outgoer" residual current devices are also available in monobloc version.



Catalogue numbers

| C40 Vigi residual current devices 4500 EN 61009 - C curve | | | |
|--|---|-----------------------|----------|
| Type | AC | Width in 9-mm modules | |
| Auxiliaries | Add-on auxiliaries: see modules CA907008 and CA907010 | | |
| 1P+N | Sensitivity | 30 mA | |
| | Rating | 6 A | A9N19275 |
| | | 10 A | A9N19276 |
| | | 16 A | A9N19277 |
| | | 20 A | A9N19278 |
| | | 25 A | A9N19279 |
| | | 32 A | A9N19280 |
| | | 40 A | A9N19281 |

| C40 Vigi residual current devices 6000 EN 60898/61009 - C curve | | | |
|--|---|-----------------------|----------|
| Type | AC | Width in 9-mm modules | |
| Auxiliaries | Add-on auxiliaries: see modules CA907008 and CA907010 | | |
| 1P+N | Sensitivity | 30 mA | |
| | Rating | 6 A | A9N19285 |
| | | 10 A | A9N19286 |
| | | 16 A | A9N19287 |
| | | 20 A | A9N19288 |
| | | 25 A | A9N19289 |
| | | 32 A | A9N19290 |
| | | 40 A | A9N19291 |

Offer selection see page 217

Librio

This sticker must be removed before publishing

Catalogue numbers



| "Outgoer" C40 Vigi modules | | | | | | | |
|----------------------------|-------------------|-------|-------------------|----------|-------------------|-----------------------|----------|
| Type | AC | A | | SI | | Width in 9-mm modules | |
| Auxiliaries | Without auxiliary | | Without auxiliary | | Without auxiliary | | |
| 1P+N | Sensitivity | 30 mA | 300 mA | 30 mA | 300 mA | 30 mA | |
| | Rating | 25 A | A9N19440 | A9N19441 | A9N19450 | A9N19451 | A9N19460 |
| | | 40 A | A9N19444 | A9N19445 | A9N19454 | A9N19455 | A9N19464 |
| | | | | | | | |
| | | | | | | | |
| 3P+N | Sensitivity | 30 mA | 300 mA | 30 mA | 300 mA | 30 mA | |
| | Rating | 25 A | A9N19442 | A9N19443 | A9N19452 | A9N19453 | A9N19462 |
| | | 40 A | A9N19446 | A9N19447 | A9N19456 | A9N19457 | A9N19466 |
| | | | | | | | |
| | | | | | | | |

Vigi modules and residual current devices

Clario, Prodis, Libro

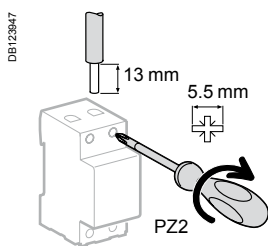
Connection



| Tightening torque | Copper cables | |
|-------------------|---|---|
| | Rigid | Flexible or with ferrule |
| 2 N.m |  0.75 to 16 mm ² |  0.33 to 10 mm ² |

- Where there is a comb busbar tooth, the connection of cables of cross section 16 mm² remains possible.
- Outgoer connection:
 - upstream: direct by comb busbar,
 - downstream: by cables.
- Group Feeder connection:
 - upstream: by cables,
 - downstream: direct by comb busbar.

■ All Vigi modules that can be combined with circuit breakers have a rating foolproofing element preventing any combination on an inappropriate circuit breaker: in accordance with Annex G of the EN 61009-1 standard

"Group Feeder" Vigi modules
 ■ The downstream terminals are located in the upper part of the device for direct connection to the comb busbar

"Outgoer" Vigi modules
 ■ The downstream terminals are located in the lower part of the device



■ Every circuit breaker combined with a Vigi module remains compatible with the indication and tripping auxiliaries

Weight (g)

| | Vigi modules | Residual current devices |
|-------------|--------------|--------------------------|
| Type | | |
| 1P+N | 90 | 210 |
| 3P | 165 | - |
| 3P+N | 210 | 520 |
| 4P | 210 | - |

Vigi modules and residual current devices

Clario, Prodis, Libro (cont.)

Dimensions (mm)

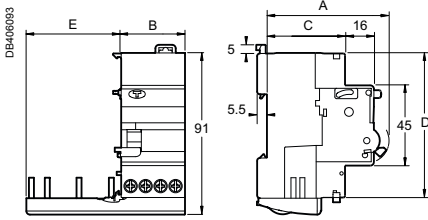

"Outgoer" Vigi modules

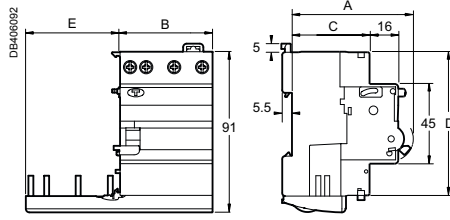

"Group Feeder" Vigi modules

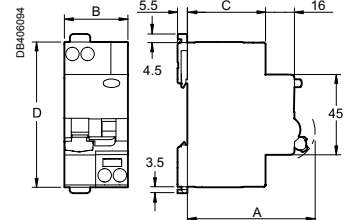

Residual current devices

Earth leakage protection

| Type | Number of poles | A | B | C | D | E |
|-----------------------------|-----------------|----|-----|----|----|----|
| "Outgoer" Vigi modules | 1P+N | 69 | 18 | 44 | 81 | 18 |
| | 3P | 69 | 36 | 44 | 81 | 54 |
| | 3P+N | 69 | 36 | 44 | 81 | 54 |
| "Group Feeder" Vigi modules | 1P+N | 70 | 18 | 44 | 82 | 18 |
| | 3P+N | 70 | 54 | 44 | 82 | 54 |
| | 4P | 70 | 54 | 44 | 82 | 72 |
| Residual current devices | 1P+N | 71 | 36 | 44 | 81 | - |
| | 3P+N | 71 | 108 | 44 | 81 | - |

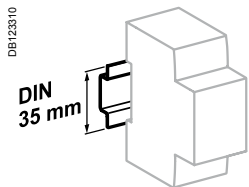

Clip on DIN rail 35 mm.

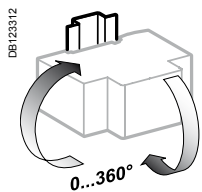

Indifferent position of installation.

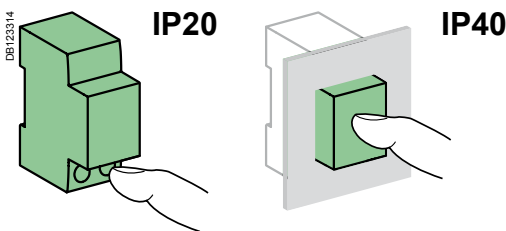

Technical data

Main characteristics

According to EN 61009

| | | |
|--|------------------|--|
| Insulation voltage (U _i) | Phase-to-phase | 440 V AC |
| Voltage rating (U _e) | Phase-to-neutral | 230 V AC |
| | Phase-to-phase | 400 V AC |
| Operating frequency | | 50 Hz |
| Pollution degree | | 3 as per IEC 61009 (for installation in industrial environment) |
| Rated impulse withstand voltage (U _{imp}) | | 4 kV |
| Behaviour in the event of a phase-to-earth fault in TN-S earthing system | | Residual breaking and making capacity (I _{Δm}) identical to the rated breaking capacity (I _{cn}) |

Additional characteristics

| | | |
|---|-----------------------------|---|
| Degree of protection | Device only | IP20 |
| | Device in modular enclosure | IP40 |
| Operating temperature | A and S/I types | -25°C to +60°C |
| | AC type | -5°C...+60°C |
| Storage temperature | | -40°C to +60°C |
| Tropicalization | | Treatment 2 (relative humidity of 95 % at 55°C) |
| Reinforced cable pull-out strength | | Serrated terminals |
| Automatic cable guiding in the correct position | | Terminals with guard |



The Schneider Electric residual current device range comprises various offers (A, B) to enable it to be the most competitive range possible in each country, allowing for the special characteristics of each market:

- usual installation procedure
- price
- accreditations by local bodies.

Variants

| Offers | | Pages |
|--------------|-------------------|-------|
| Offer A | Catalogue numbers | 228 |
| Offer B | Catalogue numbers | 229 |
| Common pages | | 230 |



Only the product range to be marketed in your country and validated by the local product manager, in agreement with his Final Distribution (FD) partner should be retained. The others will be removed before publication.





Country approval pictograms



National standard*.
European standard EN 61009.
International standard IEC 61009.

- The DPN Vigi residual current device provides complete protection for final circuits (against overcurrents and insulation faults):
 - protection for people against electric shocks by direct contacts (≤ 30 mA),
 - protection for people against electric shocks by indirect contacts (300 mA),
 - protection of installations against risk of fire (300 mA).

- The *SI* range has been designed to maintain a network with optimum safety and continuity of service in installations disturbed by:
 - extreme atmospheric conditions,
 - harmonic generating loads,
 - transient switching currents.

Catalogue numbers

DPNa Vigi 4500

| Type | A | | Width in 9-mm modules |
|---------------------|------------------------------|----------|-----------------------|
| Auxiliaries | Module CA907013 and CA907008 | | |
| 1P+N C curve | Sensitivity 10 mA | | |
| Rating (In) | 10 A | A9N19304 | 4 |
| | 16 A | A9N19305 | |
| Voltage rating (Ue) | 230 V AC | | |
| Operating frequency | 50/60 Hz | | |
| Accessories | Module CA907013 and CA907012 | | |

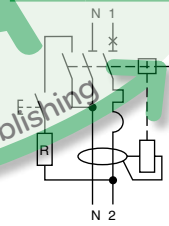

Offer selection see page 227

offer A

This sticker must be removed before publishing

Catalogue numbers

DPN N Vigi 6000

| Type | AC | | SI | | Width in 9-mm modules | |
|---------------------|------------------------------|-------------------|----------|----------|-----------------------|---|
| Auxiliaries | Module CA907013 and CA907008 | | | | | |
| 1P+N B curve | Rating (In) | Sensitivity 30 mA | 300 mA | 30 mA | 300 mA | 4 |
| | 4 A | A9N19650 | - | - | - | |
| | 6 A | A9N19651 | A9N19671 | - | - | |
| | 10 A | A9N19653 | A9N19673 | - | - | |
| | 13 A | - | - | - | - | |
| | 16 A | A9N19655 | A9N19675 | - | - | |
| | 20 A | A9N19656 | A9N19676 | - | - | |
| | 25 A | A9N19657 | A9N19677 | - | - | |
| | 32 A | A9N19658 | A9N19678 | - | - | |
| | 40 A | A9N19659 | A9N19679 | - | - | |
| 1P+N C curve | Rating (In) | Sensitivity 30 mA | 300 mA | 30 mA | 300 mA | 4 |
| | 6 A | A9N19661 | A9N19681 | A9N19631 | A9N19641 | |
| | 10 A | A9N19663 | A9N19683 | A9N19632 | A9N19642 | |
| | 13 A | - | - | A9N19633 | A9N19643 | |
| | 16 A | A9N19665 | A9N19685 | A9N19634 | A9N19644 | |
| | 20 A | A9N19666 | A9N19686 | A9N19635 | A9N19645 | |
| | 25 A | A9N19667 | A9N19687 | A9N19636 | A9N19646 | |
| | 32 A | A9N19668 | A9N19688 | A9N19637 | A9N19647 | |
| | 40 A | A9N19669 | A9N19689 | A9N19638 | A9N19648 | |
| | Voltage rating (Ue) | 230 V AC | | | | |
| Operating frequency | 50/60 Hz | | | | | |
| Accessories | Module CA907013 and CA907012 | | | | | |

* Information to be provided by the country.

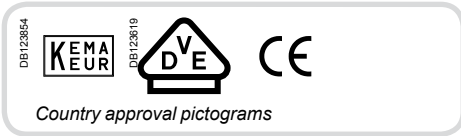

National standard*.
European standard EN 61009.
International standard IEC 61009.

■ The DPN Vigi residual current device provides complete protection for final circuits (against overcurrents and insulation faults) it ensure the protection for people against electric shocks by direct contacts.

Catalogue numbers

DPNa Vigi [4500]

| Type | A | Width in 9-mm modules | |
|---------------------|------------------------------|-----------------------|---|
| Auxiliaries | Module CA907013 and CA907008 | | |
| 1P+N C curve | Sensitivity 30 mA | | |
| | Rating (In) | | |
| | 10 A | A9N19532 | 4 |
| | 13 A | A9N19533 | |
| 16 A | A9N19534 | | |
| Voltage rating (Ue) | 230 V AC | | |
| Operating frequency | 50/60 Hz | | |
| Accessories | Module CA907013 and CA907012 | | |

Catalogue numbers

DPN N Vigi [6000]

| Type | A | Width in 9-mm modules | |
|---------------------|------------------------------|-----------------------|---|
| Auxiliaries | Module CA907013 and CA907008 | | |
| 1P+N B curve | Sensitivity 30 mA | | |
| | Rating (In) | | |
| | 6 A | A9N19753 | 4 |
| | 10 A | A9N19754 | |
| | 13 A | A9N19755 | |
| | 16 A | A9N19756 | |
| | 20 A | A9N19757 | |
| | 25 A | A9N19758 | |
| 32 A | A9N19759 | | |
| 40 A | A9N19760 | | |
| 1P+N C curve | Sensitivity 30 mA | | |
| | Rating (In) | | |
| | 6 A | A9N19771 | 4 |
| | 10 A | A9N19772 | |
| | 13 A | A9N19773 | |
| | 16 A | A9N19774 | |
| | 20 A | A9N19775 | |
| | 25 A | A9N19780 | |
| 32 A | A9N19777 | | |
| 40 A | A9N19778 | | |
| Voltage rating (Ue) | 230 V AC | | |
| Operating frequency | 50/60 Hz | | |
| Accessories | Module CA907013 and CA907012 | | |

* Information to be provided by the country.

Offer selection see page 227

Offer B

This sticker must be removed before publishing

Positive contact indication

■ A green strip on the toggle guarantees opening of all the poles in safety conditions (padlocking possible) for work to be carried out on live parts



■ Fast closing

■ Display of earth fault on the front panel by position of toggle

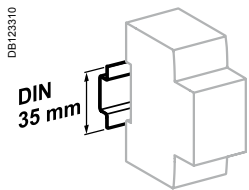

Clip on DIN rail 35 mm.

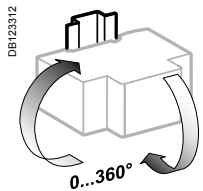

Indifferent position of installation.

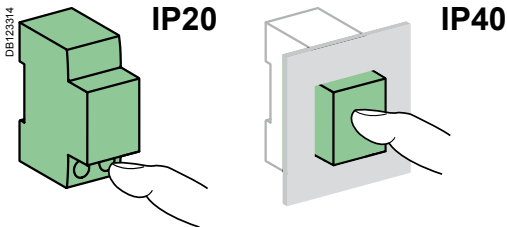

Connection

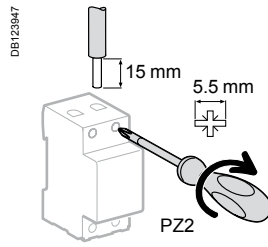

| Rating | Tightening torque | Copper cables | |
|-----------|-------------------|-------------------------|--------------------------|
| | | Rigid | Flexible or with ferrule |
| 4 to 40 A | 2 N.m | 1 to 16 mm ² | 1 to 10 mm ² |

Technical data

| Main characteristics | | |
|--|-----------|---------------------------------|
| Type | DPNa Vigi | DPN N Vigi |
| Insulation voltage (U _i) | 400 V AC | |
| Pollution degree | 3 | |
| Rated impulse withstand voltage (U _{imp}) | 4 kV | |
| Setting temperature for ratings | 30°C | |
| Earth leakage protection with instantaneous tripping | 10, 30 mA | 30, 300 mA |
| Magnetic tripping | B curve | Between 3 and 5 I _n |
| | C curve | Between 5 and 10 I _n |
| Utilization category | A | |
| Insulation class | 2 | |
| 8/20 μs impulse withstand current | AC type | 250 Å |
| | A type | 250 Å |
| | SI type | 3 kÅ |

| According to EN 61009 | | |
|---|--------|--------|
| Limitation class | 3 | |
| Rated breaking capacity (I _{cn}) | 4500 A | 6000 A |
| Rated residual breaking and making capacity (IΔm) | 4500 A | 6000 A |

| Additional characteristics | | |
|----------------------------------|--|-----------------------|
| Degree of protection (IEC 60529) | Device only | IP20 |
| | Device in modular enclosure | IP40 |
| | | Classe d'isolement II |
| Endurance (O-C) | Electrical | 20,000 cycles |
| | | 10,000 cycles |
| | Mechanical | 20,000 cycles |
| Overvoltage category (IEC 60364) | IV | |
| Operating temperature | AC type | -5°C to +60°C |
| | A, SI type | -25°C to +60°C |
| Storage temperature | -30°C to +70°C | |
| Tropicalization (IEC 60068-1) | Treatment 2 (relative humidity of 95% at 55°C) | |

Weight (g)

| Residual current device | | |
|-------------------------|-----------|------------|
| Type | DPNa Vigi | DPN N Vigi |
| 1P+N | 125 | 125 |

Dimensions (mm)

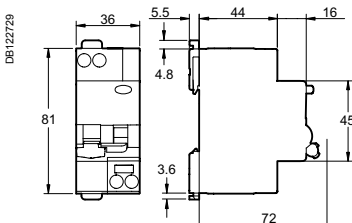

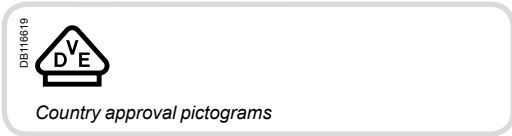

IEC 61009-1



DPN Vigi K

■ The residual current devices DPN Vigi K provides complete protection of final circuits (overcurrents and insulation faults) and the protection of people against electric shocks by direct contacts (30 mA).

- Fast closing.
- Positive break indication.
- Display of earth fault on the front panel by position of toggle.

Catalogue numbers

| DPN Vigi K | | | | AC | A | Width in 9-mm modules |
|------------------------------|--------|-------------|----------|----------|----------|-----------------------|
| Type | | | | 30 mA | 30 mA | |
| 1P+N Curve B DB119073 | Rating | Sensitivity | | 30 mA | 30 mA | 4 |
| | | 10 A | | A9D22610 | A9D23610 | |
| | | 16 A | | A9D22616 | A9D23616 | |
| | 20 A | | A9D22620 | A9D23620 | | |
| 1P+N Curve C DB119073 | Rating | Sensitivity | | 30 mA | 30 mA | 4 |
| | | 10 A | | A9D20610 | A9D21610 | |
| | | 16 A | | A9D20616 | A9D21616 | |
| | 20 A | | A9D20620 | A9D21620 | | |
| Voltage rating (Ue) | | 230 V AC | | | | |
| Operating frequency | | 50 Hz | | | | |

Connection

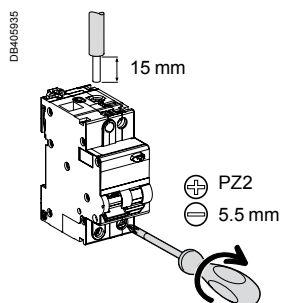

| Type | Rating | Tightening torque | Copper cables | |
|------------|------------|-------------------|-------------------------|----------------------------|
| | | | Rigid | Flexible or with end-piece |
| DPN Vigi K | 10 to 20 A | Phase | DB122945 | DB122946 |
| | | Neutral | 1 to 25 mm ² | 1 to 16 mm ² |
| | | | 1 to 16 mm ² | 1 to 10 mm ² |

Residual current devices DPN Vigi K (cont.)

The DPN Vigi K residual current device can be installed in the middle of a line of K60 circuit breakers. The phase can be powered via the biconnect comb busbar, the neutral is powered via a cable.

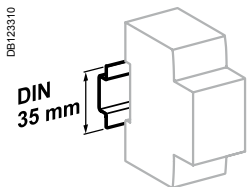
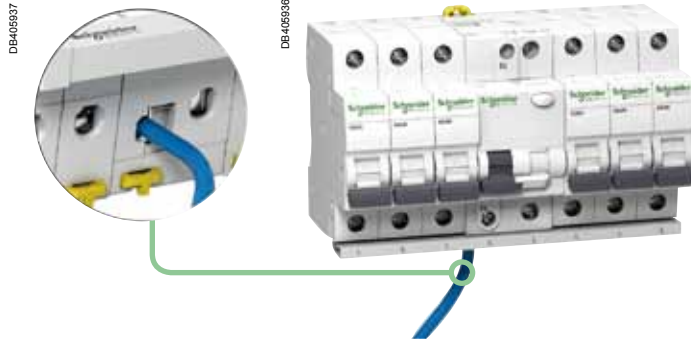

Clip on DIN rail 35 mm.

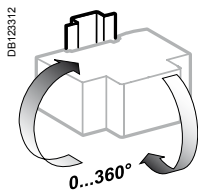

Indifferent position of installation.

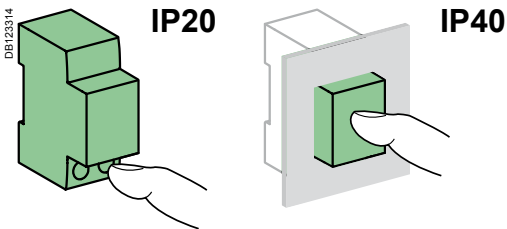

Technical data

| Main characteristics | | |
|---|-----------------------------|---|
| Insulation voltage (Ui) | | 400 V |
| Pollution degree | | 3 |
| Rated impulse withstand voltage (Uimp) | | 4 kV |
| Setting temperature for ratings | | 30°C |
| Tripping curve | Curve B | Between 3 and 5 In |
| | Curve C | Between 5 and 10 In |
| According to EN 61009 | | |
| Limitation class | | 3 |
| Rated breaking capacity (Icn) | | 6000 A |
| Rated residual breaking and making capacity (IΔm) | | 4500 A |
| 8/20 μs impulse withstand without tripping | AC type | 250 Å |
| | A type | 250 Å |
| Additional characteristics | | |
| Degree of protection | Device only | IP20 |
| | Device in modular enclosure | IP40 |
| | | Insulation class II |
| Endurance (O-C) | Electrical | 20000 cycles |
| | Mechanical | 20000 cycles |
| Overvoltage category (O-C) | | III |
| Service temperature | AC type | -5°C to +40°C |
| | A type | -25°C to +40°C |
| Storage temperature | | -30°C to +70°C |
| Tropicalization | | Treatment 2 (relative humidity 95% at 55°C) |

Weight (g)

| Residual current device | |
|-------------------------|------------|
| Type | DPN Vigi K |
| 1P+N | 125 |

Dimensions (mm)

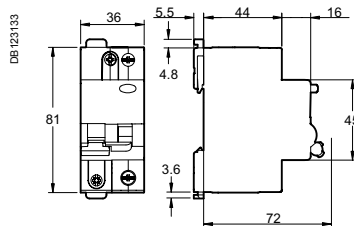

DPN Vigi K

PB107511-60



Standards: IEC 61009-2-2, AS/NZS 61009-1.

- The single-phase SPN N Vigi self-contained residual current device carries out:
 - protection of persons against direct and indirect contacts (30 mA)
 - complete protection of final circuits (overcurrents and insulation faults)
 - safety device to switch both of active and neutral
- A class SPN N Vigi are sensitive to the pulsed type DC component.
- Overload, short circuit and earth fault currents are indicated by location of the handle in the OFF position.
- A push-test button "T" is positioned on the front of the device for testing that product is operational.

Accessories

Padlocking device

- Used to lock the toggle in the "open" or "closed" position by 8 mm diameter padlock (not supplied).

1P+N comb busbars

- The comb busbars make it easier to install Schneider Electric products.

Catalogue numbers

| SPN N Vigi | | | | |
|---------------------|---------------------------|-------------|-------------------|-----------------------|
| Type | | | A | Width in 9-mm modules |
| C curve | Voltage rating (V) 240 | Rating (In) | Sensitivity (IΔn) | 30 mA |
| | | | 10 A | 19583 |
| | | | 16 A | 19584 |
| | | | 20 A | 19585 |
| | | | 25 A | 19586 |
| Operating frequency | | | 50 Hz | |

| Accessories | |
|--|-------|
| Type | |
| Padlocking device (bag of 2 pieces) | 26970 |
| 1P+N comb busbar 26 modules of 9-mm | 14880 |
| 1P+N comb busbar 48 modules of 9-mm | 14890 |
| Side-plates (bag of 40 pieces) | 14886 |
| Tooth cover end-piece (bag of 40 pieces) | 14888 |

DB124106

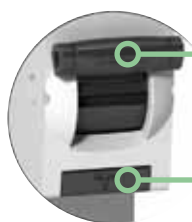

■ Trip-free handle through an over-center toggle mechanism that ensure tripping even when the handle is held or locked in the ON position

■ Test push-button

Connection

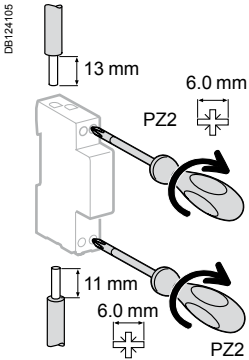

| Type | Rating | Tightening torque | Copper cables | |
|--------------------|------------|-------------------|-------------------------|-------------------------|
| | | | Rigid | Flexible |
| L and N upstream | 10 to 25 A | 2 N.m | 1 to 16 mm ² | 1 to 16 mm ² |
| L and N downstream | | 2 N.m | 1 to 10 mm ² | 1 to 10 mm ² |

Note: for any case, isolate power before installation. Wire neutral prior to installing active.

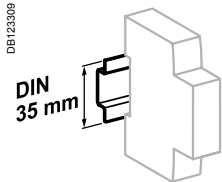

Clip on DIN rail 35 mm.

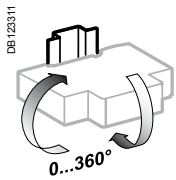

Indifferent position of installation.

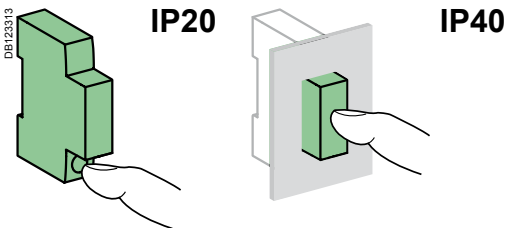

Technical data

| Main characteristics | | |
|---|---|---------------------|
| Voltage rating (Ue) | 240 V + 10 %, -15 % | |
| Insulation voltage (Ui) | 400 V | |
| Rated impulse withstand voltage (Uimp) | 4 kV | |
| Rated residual operating current (IΔn) | 30 mA | |
| Thermal tripping | Reference temperature | 30°C |
| Magnetic tripping | C curve | Between 5 and 10 In |
| Limitation class | 3 | |
| Surge current withstand (8/20 μs) without tripping | 3000 A | |
| Rated nominal breaking capacity (Icn) | 6000 A | |
| Phase/earth rated residual breaking and making capacity (IΔm) | 500 A | |
| Additional characteristics | | |
| Degree of protection | Device only | IP20 |
| | Device in modular enclosure | IP40 |
| Endurance (O-C) | Electrical | 10,000 cycles |
| | Mechanical | 20,000 cycles |
| Operating temperature | -5°C to +40°C | |
| Storage temperature | -25°C to +70°C | |
| Tropicalization | Treatment 2 (relative humidity: 95 % at 55°C) | |

Dimensions (mm)

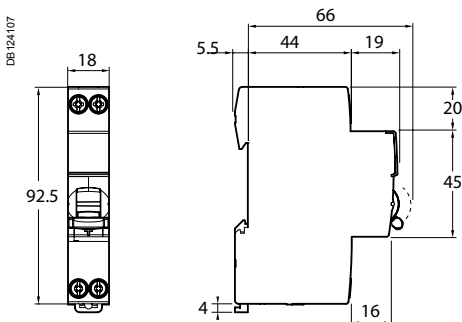

Weight (g)

| Residual current device | |
|-------------------------|------------|
| Type | SPN N Vigi |
| 1P+N | 136 |

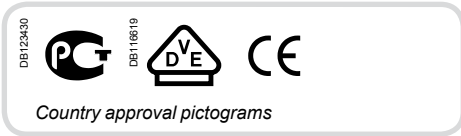

IEC/EN 61009-1



DPN N Vigi

- The DPN N Vigi residual current device provide complete protection for final circuits (against overcurrents and insulation faults):
 - protection for users against electric shocks by direct contacts (30 mA),
 - protection for users against electric shocks by indirect contacts (300 mA),
 - protection of the installations against fire risks (300 mA).

- The *SI* range has been designed to maintain a network with optimum safety and continuity of service in installations disturbed by:
 - extreme atmospheric conditions,
 - harmonic generating loads,
 - transient operating currents.

Catalogue numbers

| DPN N Vigi 6000 | | | | | | | | |
|---------------------|---|------|----------|----------|----------|-----------------------|----------|----|
| Type | AC | A | | SI | | Width in 9 mm modules | | |
| Auxiliaries | Module CA907013 and CA907008 | | | | | | | |
| 3P+N Curve B | Sensitivity 30 mA | | 300 mA | | 30 mA | | | |
| | Rating (In) | 6 A | A9D55706 | - | A9D56706 | - | - | 10 |
| | | 10 A | A9D55710 | - | A9D56710 | - | - | |
| | | 13 A | - | - | A9D56713 | - | - | |
| | | 16 A | A9D55716 | - | A9D56716 | - | - | |
| | | 20 A | A9D55720 | - | A9D56720 | - | - | |
| | | 25 A | A9D55725 | - | A9D56725 | - | - | |
| | | 32 A | A9D55732 | - | A9D56732 | - | - | |
| | | 40 A | A9D55740 | - | A9D56740 | - | - | |
| | Rating (In) | 6 A | A9D31706 | - | A9D32706 | - | - | 10 |
| | | 10 A | A9D31710 | A9D41710 | A9D32710 | A9D42710 | A9D33710 | |
| | | 13 A | - | - | A9D32713 | - | A9D33713 | |
| | | 16 A | A9D31716 | A9D41716 | A9D32716 | A9D42716 | A9D33716 | |
| | | 20 A | A9D31720 | A9D41720 | A9D32720 | A9D42720 | A9D33720 | |
| | | 25 A | A9D31725 | A9D41725 | A9D32725 | A9D42725 | A9D33725 | |
| | | 32 A | A9D31732 | A9D41732 | A9D32732 | A9D42732 | A9D33732 | |
| | | 40 A | A9D31740 | A9D41740 | A9D32740 | A9D42740 | A9D33740 | |
| Voltage rating (Ue) | 400 V AC | | | | | | | |
| Operating frequency | 50 Hz | | | | | | | |
| Accessories | Module CA907013 and CA907012, Comb busbars LIN001 | | | | | | | |

- Fast contact closure
- Double clip for dismantling with comb busbar in place
- Possibility of mixing iDPN Vigi 1P+N and DPN Vigi 3P+N devices on the same row and on the same comb busbar.
- Insulated terminals IP20
- Test button
- Positive contact indication**
 - A green strip on the toggle guarantees opening of all the poles in safety conditions (padlocking possible) for work to be carried out on live parts