

Recorder & Temperature Controller

RT9

INSTRUCTION MANUAL

Thank you for the purchase of **HANYOUNG** product.
Please read this manual carefully.



Contents

1. SAFETY INFORMATION	4
2. INSTRUCTION	6
3. ORDERING INFORMATION	6
4. SPECIFICATION	7
5. DIMENSIONS & PANEL CUTOUT	11
6. TERMINAL ARRANGEMENT	11
7 NAME & FUNCTION	12
8. TABLE OF SETTING ITEMS	13
10. SETTING METHOD	15
20. GROUP SETTING	16
21. FUNCTION	23

RT9

Universal Input · Output / Small-sized Recorder & Temperature controller (±0.3 class high accuracy)



Model : RT9

Features

- Zoom function
- Various Alarms
- Universal Input · Output
- Interface (RS485)
- Free scale
- PID Auto tuning
- Record and Temperature control



HANYOUNG

1 SAFETY INFORMATION

Before using, please read this (SAFETY INFORMATION)

It is most important that the instructions in this manual are followed when using this instrument. Please keep this manual for future reference.

Precautions are classified as **WARNING** and **CAUTION**.

 WARNING	There is a possibility of death or heavy injury when handling in wrong way.
 CAUTION	There is a possibility of injury or physical damage when handling in wrong way.

WARNING

1. Caution on wiring

- Use an external protection circuit if a fault in the control loop could possibly lead to a serious problem.
- This instrument does not have a switch for power and a fuse, so please install them if required. (Fuse rating 250V, 0.5A)

2. Power supply

- Use a rated voltage to prevent damage or trouble.
- To avoid electrical shock or damage, do not turn ON the power until the wiring is completed.

3. Prohibit use in gas atmosphere

- Do not use it at a place exposed to combustible or explosive gas.

4. Handling of unit

- To avoid malfunction, electrical shock or fire, this unit must not be disassembled or repaired.
- Do not touch the terminals to avoid electrical shock or malfunction.

5. Caution on maintenance

- Turn OFF the power before mounting or removing the instrument.
- To ensure continuous and safe operation of the instrument, periodical maintenance is recommended. Some parts are limited in life.
- The warranty period is 1 year only if using in the correct way.

CAUTION

1. Caution on handling

Do not install the instrument under any of the following conditions.

- The ambient temperature exceeds 0 ~ 50 °C
- The ambient humidity exceeds 20 ~ 90%RH.
- A place where temperature changes suddenly or icing occurs.
- A place exposed to corrosive gas or combustible gas.
- Vibration or shock is likely to be transmitted to the instrument.
- A place exposed to water, oil, chemicals, steam, sunlight.
- A place exposed to much dust, salt or iron.
- A place with much inductive disturbance, static electricity, magnetism noise.
- A place where heat such as radiant heat stays.

2. Installation

- Attach the brackets (2 units) on the fixed halls and tighten with a screwdriver.
Fixing torque is about 14.7N. cm (1.5kg.cm).
(Care should be taken not to tighten forcedly.)
- Indoor use.
- Altitude up to 2000m use.
- Mains supply voltage fluctuations not to exceed ± 10 of the normal voltage.
- Installation Categories II
- Pollution degree 2

3. Caution on terminal connections

- Use a compensating cable with thermocouple.
- For R.T.D input use a cable which is a small lead wire resistance and without resistance difference to 3wires.
- To avoid inductive noise to input wires separate from the power and output wires.
- Keep input wires away from output wires and use shielded wires to earth.
- If the wiring has noise, use the following step: connect a surge absorber to the conductor coil side if the conductors are connected to the load output, such as the relay contact output.
- Use an insulating transformer with a noise filter when the power supply has much noise.
- Noise filter should be mounted on a panel which has been earthed and the wiring between the noise filter output and the instrument power terminals should be shorten.
- It is effective to use a twisted cable for power supply against noise.
- The heater power supply and the instrument power supply should be connected using the same power supply when a heater break alarm.
- Time for preparation of contact output is required at power ON. When the output signal is used for an external interlock circuit, connect a delay relay.

4. For load circuit connection

- Use an extra relay when the frequency of operation is rather high. In this case, SSR output type is Recommended.
- Electromagnetic switch : Proportional cycle time is Min. 30 sec
- SSR : Proportional cycle time is Min. 2 sec
- Contact output life : Mechanical : Min. 10 million times (no load)
Electrical : Min. 100 thousand times (rated load)
- SSR drive pulse voltage, DC 4~20mA are not insulated with internal circuit.
Use non-grounded sensor to R.T.D and thermocouple.

5. Caution on key operation / trouble

- If alarm function is not set correctly, alarm output can not operate correctly a trouble.
Be sure to check the alarm operation.
- If the input cable is disconnected, the display shows "b.oUt".
When replacing the sensor, please turn OFF the power supply.

6. Other

- Do not use organic solvents such as alcohol, benzene when cleaning. (Use neutral detergent)

2

INSTRUCTION

This instrument has process-value (PV) and set-value (SV) each 4 digits with 7 segment FND. This instrument is divided either Recorder and Recorder with Controller.

●Function and feature

: Group P.I.D, Universal-input (19 types), Universal-output (Relay, SSR, SCR), Auto-tuning 2 types (standard type, low PV type), Communication (RS485), 20 types of alarm, Sampling cycle 250ms, ± 0.3 of FS high accuracy. And there are Zoom function, Graphic or Text printing selectable function, List printing function, Feed function, Free scale function. RT9 is the smallest Recorder with controller.

3

ORDERING INFORMATION

Model	Suffix code	Description
RT9 -	<input type="checkbox"/> <input type="checkbox"/> <input type="checkbox"/>	96 × 96 mm
	0	Recorder
	1	Recorder & Temperature Controller
	0	°C
	1	Others
	0	None
	1	Alarm 1
	2	Alarm 1, 2
	3	RS485
	4	RS485 / Alarm 1
	5	RS485 / Alarm 1, Alarm 2

※Control output

Recorder & Temperature Controller	Output code	Control Output
RT9 - 1 <input type="checkbox"/> <input type="checkbox"/>	0	Relay (ON / OFF control)
	1	SSR
	2	SCR (4 ~ 20 mA DC)
	3	Relay (P.I.D control)

■ INPUT

Input	Thermocouple : K, J, E, T, R, S, B, L, N, U, WRe 5-26, PL- II R.T.D : Pt 100 Ω , KPt 100 Ω Direct voltage: 1 ~ 5 V, -10 ~ 20 mV, 0 ~ 100 mV (Free scale type)
Sampling time	250 mS
Input resolution	Below decimal point of measurement range
Input impedance	T/C and mV input : 1 M Ω min., V DC : 1 M Ω
Lead wire tolerable resistance	R.T.D : 10 Ω max. / wire
Input tolerable voltage	± 10 V (T/C, R.T.D, Voltage : mV DC), ± 20 V (Voltage : V DC)
Noise removal rate	NMRR(normal mode) : 40 dB min. CMRR(common mode) : 120 dB min. (50/60 Hz ± 1 %)
Standard	T/C, R.T.D: KS, IEC, DIN
Standard junction temp. compensation tolerance	± 1.5 $^{\circ}\text{C}$ (15 ~ 35 $^{\circ}\text{C}$), ± 2.0 $^{\circ}\text{C}$ (0 ~ 50 $^{\circ}\text{C}$)
Burn-out	T/C : OFF, Up/Down selectable R.T.D : Up scale (Detection current : 50 mA)
Accuracy	± 0.3 % (Full scale)
Input range	Refer to "Input signal and Measurement range" T/C and R.T.D are changeable within range of input signal and measurement range. Voltage: min. voltage and max. voltage are available within range of measurement. Scaling available.

■ OUTPUT

● CONTROL OUTPUT

Relay contact output	Contact capacity : 240 V AC 3 A, 30 V DC 3 A (resistive load), Contact : 1 C Output operation : P.I.D control, ON/OFF Proportional cycle : 1 ~ 1,000 sec. Output limit : 0.0 ~ 100.0 % range, higher limit(OH) or lower limit(OL) selectable (valid when AT) ON/OFF hysteresis : 0 ~ 100 %(Full scale) Time resolution : 0.1 % or 10 mS
SSR drive voltage output	ON voltage : 24 V DC min.(resistive load 600 Ω min., 30 mA limit when short) OFF voltage : 0.1 V DC max. Proportional cycle : 1 ~ 1,000 sec. Output operation : P.I.D control Output limit : 0.0 ~ 100.0 % range, higher limit(OH) or lower limit(OL) selectable (valid when AT) Time resolution : 0.1 % or 10 mS
Current output (4 ~ 20 mA DC)	Current output range : 4 ~ 20 mA DC, Resistive load : 600 Ω max. Accuracy : ± 0.5 % of full scale (4 ~ 20 mA range), Resolution : Approx. 3,000 Output ripple : 0.3 %(P-P) of max. scale (150 Hz) Sampling time : 250 mS Output operation : P.I.D control Output limit : -5.0 ~ 105.0 % range, higher limit(OH) or lower limit(OL) selectable (valid when AT)

●ALARM

Relay contact output	Contact capacity : 240 V AC 1 A, 30 V DC 1 A(resistive load) Contact: 1 a Output points: 2 Points (AL1,AL2)
----------------------	---

■ FUNCTION

Measurement input	Input correction (Bias): -100.0 ~ 100.0 % for instrument range Scaling : According to SH, SL of measurement range Filter : OFF, 1 ~ 120 sec.
Control	3 settings (SV1, SV2 and SV3) and P.I.D setting each Auto tuning : According to set value (Standard type, Low PV type) Proportional Band : 0.1 ~ 999.9 % (Max. range) Integral Time : OFF, 1 ~ 6000 sec. Derivative Time : OFF, 1 ~ 6000 sec. ON/OFF control : By selecting output code (OT) “ 0 ” P.I.D selection : Zone PID/Auto 1,2,3, selectable Manual Reset : -5.0 ~ 105.0 % of output (valid when I=OFF) Direct / Reverse action : Changeable by parameter Preset output limit : -5.0 ~ 105.0 % of output value ON/OFF hysteresis (HYS) : 0.0 ~ 100.0% of instrument range (valid when ON/OFF control) A.R.W(Anti Reset Wind-up) : AUTO, 50.0 ~ 200.0 % Fuzzy : selection ON or OFF by parameter Ramp function
Alarm output	Set point : 2 Points Multi-alarm : High/Low process alarm, High/Low deviation alarm, Hold function of alarm, Heater break alarm (H.B.A) Setting range : Process alarm 0 ~ 100 % of instrument range Deviation alarm -100 ~ 100 % of instrument range
Record	Measuring point : 1 Response time : According to chart speed Record type : Thermal line, 203 dpi(8.0 dots/mm) 384 dots / 1 line Record speed : 24 mm/h ~ 900 mm/h Paper : Width 57.5 mm, Length 16 m

■ OPERATING ENVIRONMENT

Installation environment	Continuous vibration (5~14Hz): Forward width 1.2 mm max. (4~150Hz): 4.9 m/s^2 (0.5 G) max. Vibration : 14.7 m/s^2 , 15 sec. max. (each 3 direction) Shock : 147 m/s^2 (15 G), 11 msec max. (6 direction each 3 times) Panel cutout: Refer to page 11
Normal operation condition	Ambient temperature : 0 ~ 50 °C Ambient humidity : 35 ~ 85 % RH (no condensation) Influence of magnetic : 400 AT/m max. Warm-up time: 30 min. min.
Influence of ambient temperature	T/C, Voltage input : $\pm 1 \mu V/^\circ C$ or $\pm 0.01 \%/^\circ C$ of max. range R.T.D input : $\pm 0.05 \Omega/^\circ C$ max. Analog output : $\pm 0.05 \%/^\circ C$ max. (continuous output)

■ STORAGE CONDITION

Storage temperature	-25 ~ 70 °C
Storage humidity	5 ~ 95 % RH (no condensation)
Shock	1 m max. in packing condition

■ STRUCTURE

MODEL	External Dimension	Weight	Material
RT9	96(W) × 96(H) × 100(D) mm	530 g	Plastic case(ABS)

■ POWER SUPPLY

Power supply	100 ~ 240 V AC (90 ~ 264 V AC)
Frequency	50/60 Hz
Power consumption	6.0 W max., 10 VA max.
Insulation resistance	Between primary terminal and secondary terminal : 500 V DC, 20 MΩ min. Between primary terminal and ground : 500 V DC, 20 MΩ min. Between ground and secondary terminal : 500 V DC, 20 MΩ min.
Dielectric strength	Between primary terminal and secondary terminal : 2,300V AC 50/60 Hz for 1 min. Between primary terminal and ground : 2,300 V AC 50/60 Hz for 1 min. Between F · G and secondary terminal : 1,500 V AC 50/60 Hz for 1 min.

■ SAFETY AND EMC STANDARD

Safety standard	Under process
EMC standard	Under process

■ INTERFACE

Standard	EIA RS485
Communication address	Max. 31 (1 ~ 99 setting available)
Communication method	2 wire half duplex or 4 wire half duplex
Synchronization	Start-stop synchronous mode
Communication sequence	None
Communication distance	1.2 Km max.
Communication speed	600, 1200, 2400, 4800, 9600 BPS (Speed is changeable by parameter)
Start bit	1 BIT
Data bit	7 or 8 BIT
Parity bit	None, even numbers, odd numbers
Stop bit	1 or 2 BIT
Communication protocol	PC LINK WITHOUT SUM(0), PC LINK WITH SUM(1)
Response time	Reception treatment time + (Response time × 10 mS)

■ INPUT SIGNAL and MEASUREMENT RANGE

Input type (Input signal)		Input code	Range (°C)	Range(°F)	Accuracy	Remarks	
Thermo-couple (T.C)	K ※2	1	-200~1370	-300~2500	±0.3 % of F.S ±1 digit	<ul style="list-style-type: none"> • F.S is maximum value ~ minimum value of each RANGE. • Digit is minimum value of display 	
	K ※2	2	-199.9~999.9	0~2300			
	J ※2	3	-199.9~999.9	-300~2300			
	E ※2	4	-199.9~999.9	-300~1800			
	T ※2	5	-199.9~400.0	-300~750			
	R ※2	6	0~1700	32~3100	±0.3 % of F.S ±1 digit		
	B ※1	7	0~1800	32~3300			
	S	8	0~1700	32~3100	±0.3 % of F.S ±1 digit		※1
	L ※2	9	-199.9~900.0	-300~1300			0 ~ 400 °C : ±10 % of F.S ±1 digit
	N	10	-200~1300	-300~2400			±1.0 % of F.S ±1 digit
	U ※2	11	-199.9~400.0	-300~750	±0.3 % of F.S ±1 digit		※2
	W	12	0~2300	32~4200			
Platinel II	13	0~1390	32~2500	0 °C and below : ±1.0 % of F.S ±1 digit			
R.T.D	KS Pt 100 ※3	20	-199.9~500.0	-199.9~999.9	±0.3 % of F.S ±1 digit	※3 -150.0~150.0 °C range : ±1.0 % of F.S ±1 digit	
	Pt 100 ※3	21	-199.9~640.0	-300~1180			
Direct voltage (V DC / mV DC)	1 ~ 5 V DC	30	1 ~ 5 V				
	0 ~ 10 V DC	31	0 ~ 10 V DC				
	-10 ~ 20 mV DC	32	-10 ~ 20 mV				
	0 ~ 100 mV DC	33	0 ~ 100 mV				
Direct Current	4 ~ 20 mA DC	※ 30	※ When using current input, use the resistor 250 Ω 0.1 % on input terminal.				※ 20 → KPt 100 ※ 21 → DPt 100

5

DIMENSIONS & PANEL CUTOUT

(Unit : mm)

RT9 (96 × 96 mm)

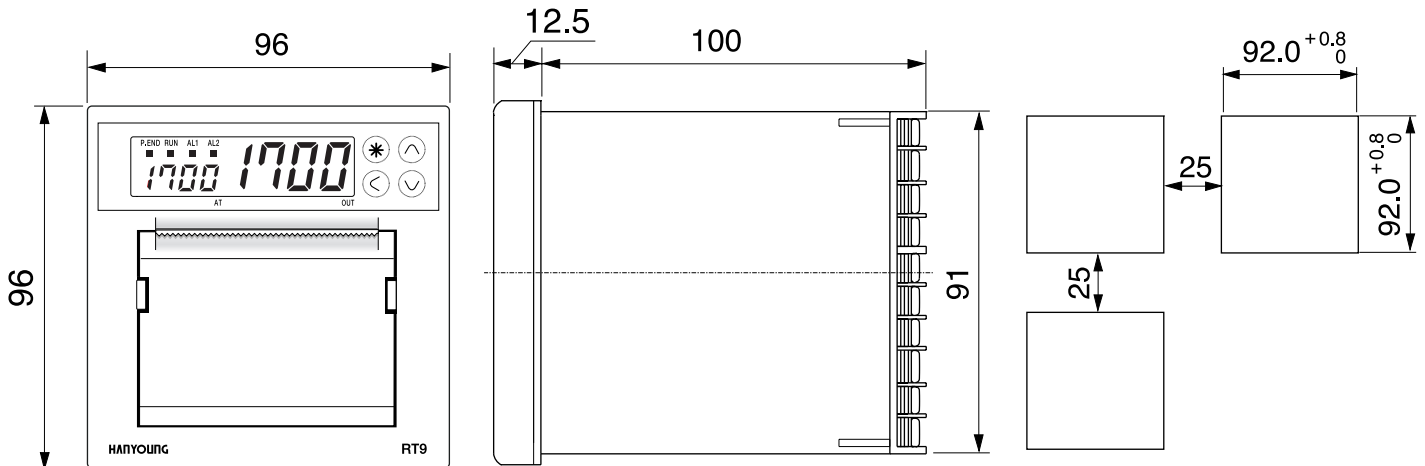

6

TERMINAL ARRANGEMENT

POWER :
 100 - 240V ~ a.c. 50 / 60Hz 6W
 CONTACT RATE : OUT
 3A 240V ~ a.c.
 (Resistive load)
 AL1.2 : 1A 240V ~ a.c.
 CURRENT OUT : 4-20mA ≐ d.c.
 (Resistive load 600 Ω max.)
 SOLID OUT : 24V ≐ d.c.
 (Resistive load 600 Ω min.)
 "MAX.AMBIENT TEMP : 50°C"
 "NOTE : Use Copper or
 Copper clad Aluminum
 Conductors Only"

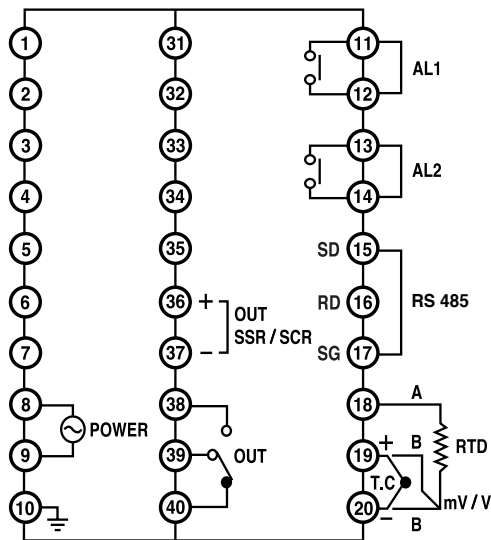

Terminal structure

Control Output	Relay(Terminal no. ③⑧ ③⑨ ④①) SSR / SCR (Termina no. ③⑥ ③⑦)
POWER	100 - 240 V AC 50/60 Hz. (Termina no. ⑧ ⑨)
Input	Termocouple: ①⑨ → +, ②① → - R.T.D: ①⑧ A, ①⑨ ②① → B Direct Voltage : ①⑨ → +, ②① → -
AL1 / AL2	Alarm1 (Terminal no. ①① ①②) Alarm2 (Terminal no. ①③ ①④)
Communication	Sending data (①⑤) Receiving data (①⑥) Earth for signal(①⑦)

7

NAME & FUNCTION



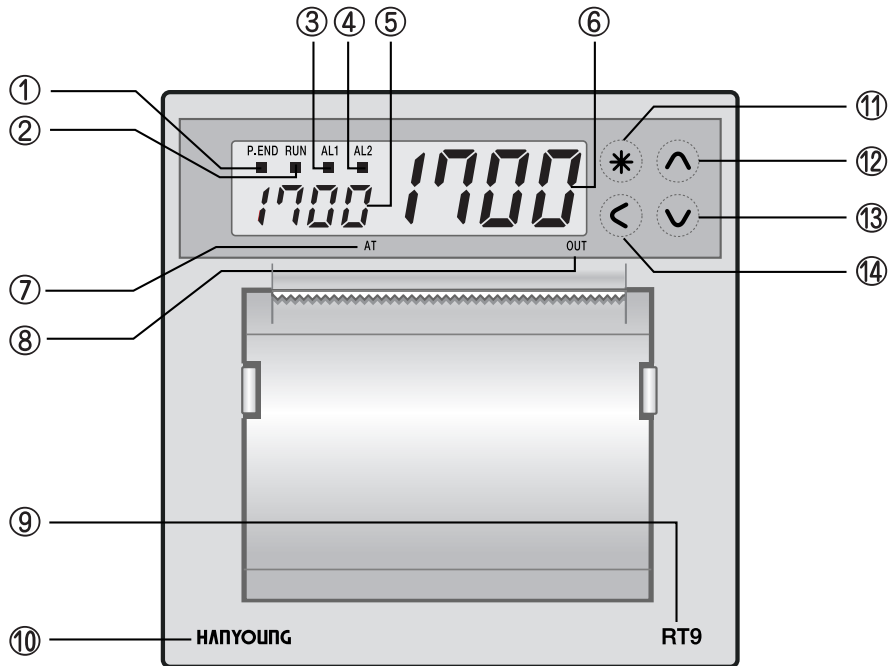

■ Front



■ Displays

Name	Functions
① P.END	No paper
② RUN	Recording in progress
③ AL1	Alarm 1 ON
④ AL2	Alarm 2 ON
⑤ Set-value(SV)	Displays set value and various parameters.(RT9-0 : Displays input type)
⑥ Process-value(PV)	Displays the process value. When setting, displays various modes.
⑦ AT	Flickers when the auto tuning operates.
⑧ OUT	Lights when the control output is ON.
⑨ RT9	Model name
⑩ HANYOUNG	Manufacturer

■ Control keys

Key	Functions
⑪ 	Used to change mode.
⑫ 	Used to increase set-value.
⑬ 	Used to decrease set-value.
⑭ 	Used to select digit for changing.

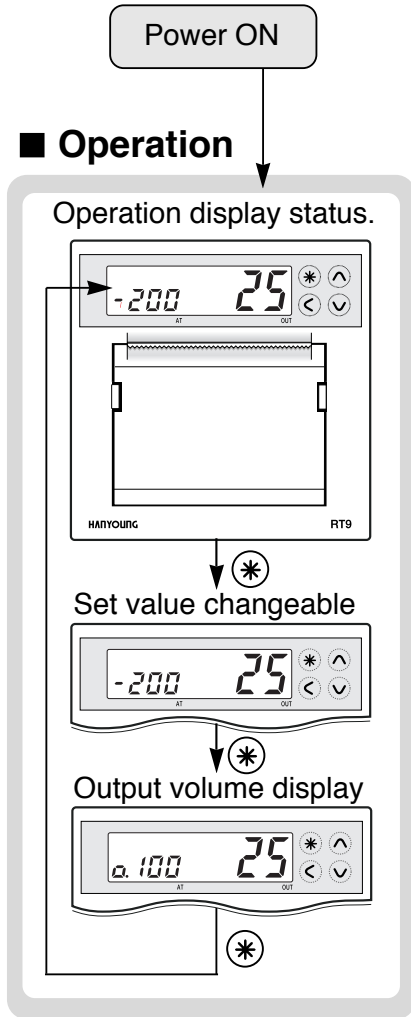

■ Menu screen

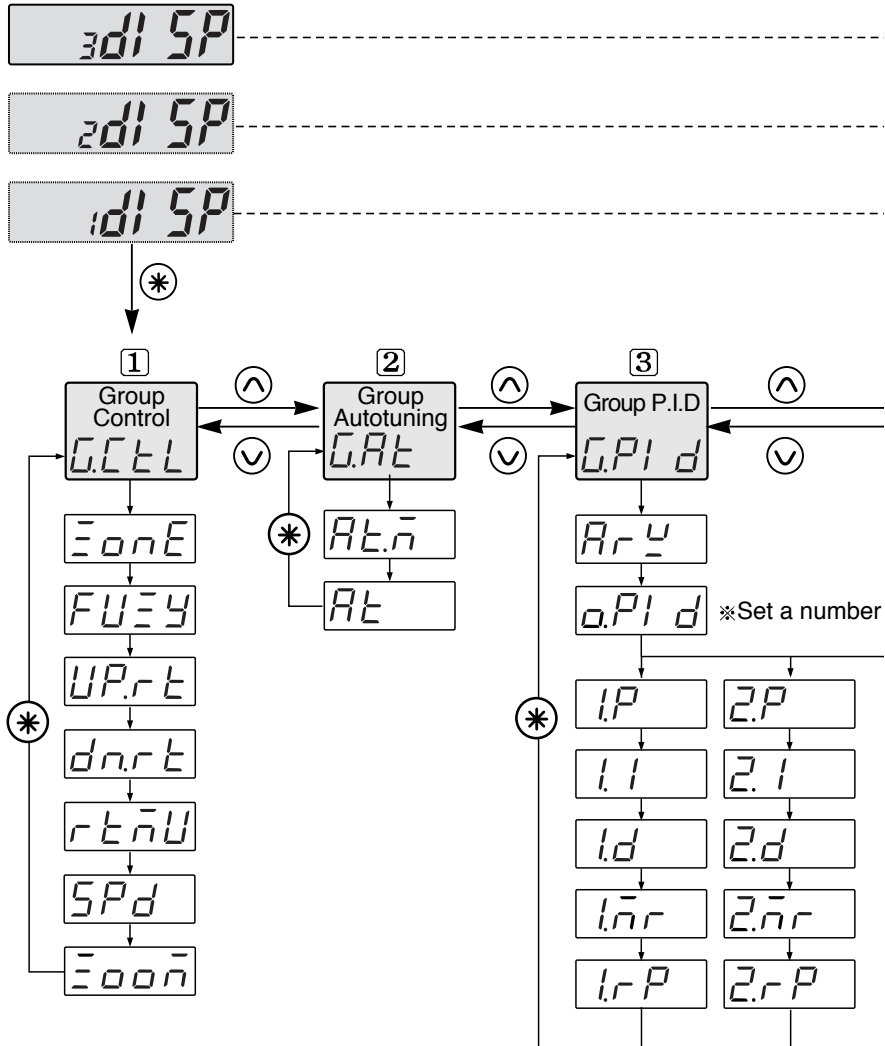

※Parameter structure

- Recorder only (RT9-0):
- Control group
- Alarm group (Optional)
- Communication group (Optional)
- Input group
- Time setting group will be displayed.

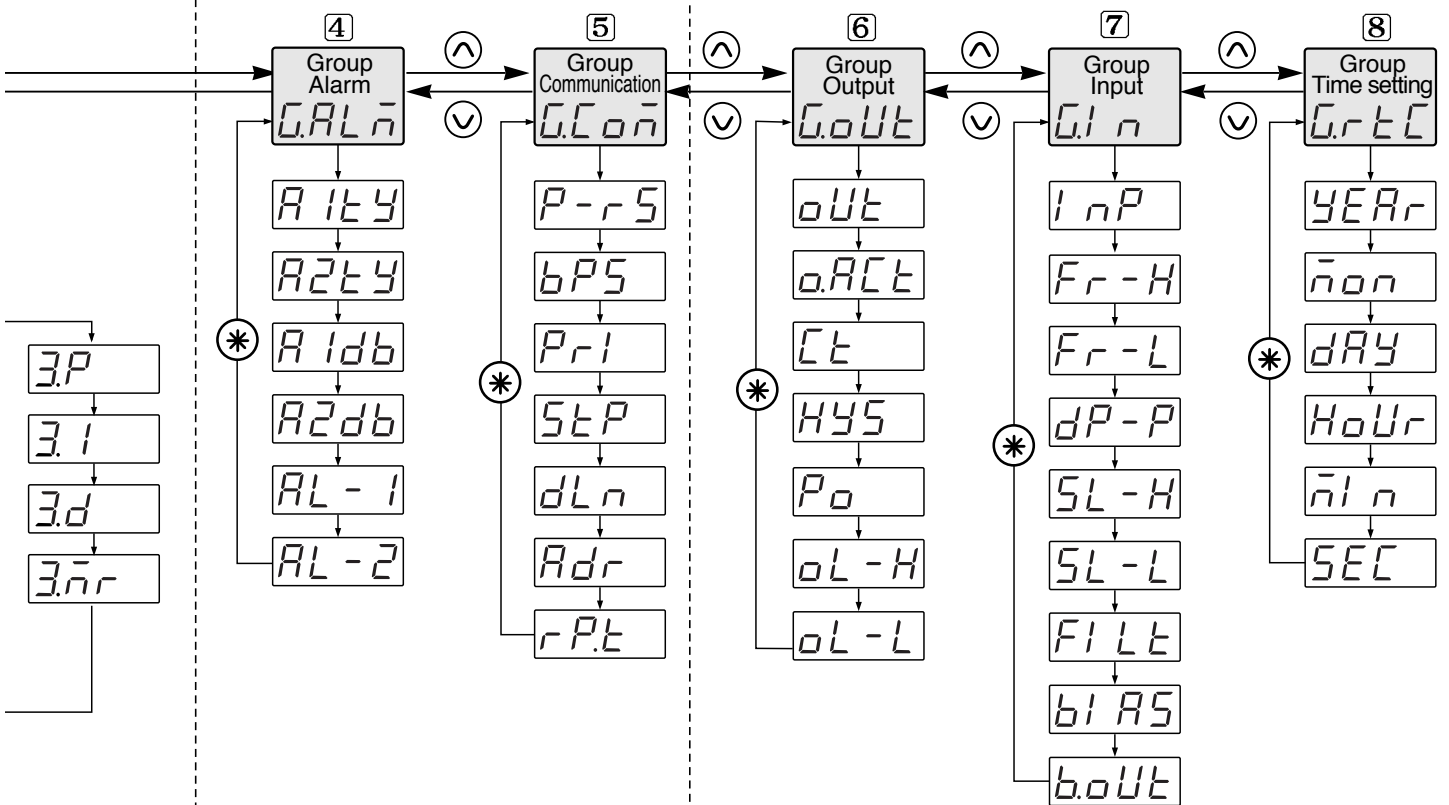

- After completion of wiring, apply power ON.
- Management version indicated as below and then present PV and SV will be indicated.
(Record exclusive use : Input type and PV will be indicated)
- For setting a level, press \odot button for 3 sec. to enter 3d1 SP setting mode. (Initial value : 3)
- In the 3d1 SP condition, press \odot button to enter group control.

Parameter shift

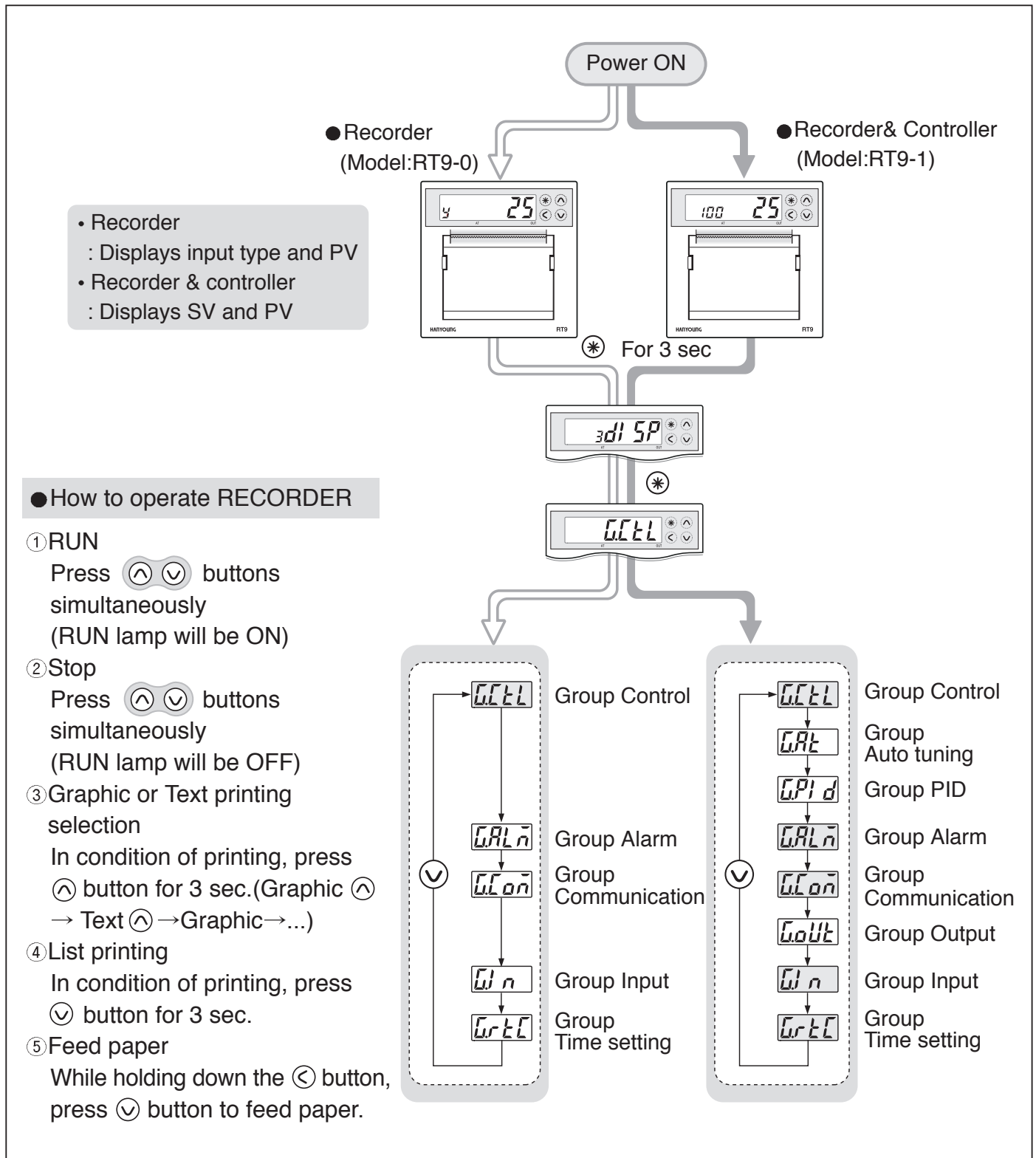

※ Display level setting

Signal	Display Name	Description	Condition	Initial
	Display level setting	Divide display levels into 3 stages (1~3)	Always	3

This controller has 3 different levels of setting, thereby restricting operator access if so desired.

■ Control group setting

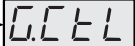
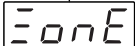
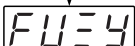
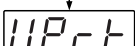
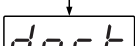
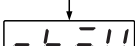
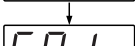
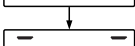
Signal	Name	Description	Condition	Initial
	Control group display	Set a control mode	Always	—
	Zone selection 1	OFF / ON	Except ON/OFF	OFF
	Fuzzy function	OFF / ON	Always	OFF
	Initial increasing temperature	OFF / EUS (0~100 %)	Always	OFF
	Initial decreasing temperature	OFF / EUS (0~100 %)	Always	OFF
	Time unit	HOUR / MIN	Always	HOUR
	Set speed of transmission	24 ~ 900 mm/hour	Always	60
	Zoom	OFF / ON	Always	OFF



■ Auto tuning group setting (Model: RT9-1)

Signal	Name	Description	Condition	Initial
	Auto tuning group	Indicates Auto-tuning	RT9-1	—
	Auto tuning type	Std / Low	ABS	STD
	Auto tuning start	OFF / 1~3 / AUTO	ABS	OFF

● Auto-tuning

The Auto tuning function automatically measures, computes and set the optimum P.I.D value.

[Note] After setting all group, select “ AUTO ”in Auto tuning group.

● Auto-tuning type

This controller has two types of auto tuning as STD (standard type) and Low.

(Low PV type : SV-10%)

● Auto-tuning start · stop

- Auto tuning start : 1~ 3 selection

(After auto tuning , P.I.D value will be stored at a selected number)

- *AUTO* Selection

When setting a value on 1.RP and 2.RP, it is stored in group 1,2,3 automatically

- Auto tuning stop : Select OFF

■ P.I.D Group setting (Model: RT9-1)

Signal	Name	Description	Condition	Initial
	P.I.D group	Set P.I.D mode	RT9-1	—
	Anti Reset Wind-up	Auto / 50.0 ~ 200.0 %	Except ON/OFF	Auto
	P.I.D group selection	0 / 1 ~ 3	Always	0
	n.Proportional band (P)	0.1 ~ 999.9 %	P.I.D group	5.0 %
	n.Integral time (I)	OFF / 1 ~ 6000 sec	P.I.D group	240 sec
	n.Derivative time (D)	OFF / 1 ~ 6000 sec	P.I.D group	60 sec
	n.Manual reset	-5.0 ~ 105.0 %	Integral time : OFF	50.0 %
	n.Zone position	EU(0) < 1.RP < 2.RP < EU(100.0 %)	ZONE : ON	EU (100.0 %)

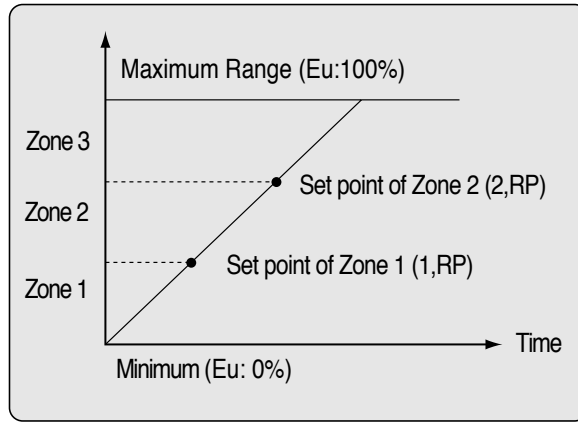

When checking P.I.D. values or setting SV in manual mode, this can be done in P.I.D. Group. Press \odot key to get Anti Reset Wind value by auto or manual and then press \odot once more to be indicated P.I.D mode which is selectable 3 types of P.I.D group (0~3). Example, "0" is no P.I.D mode and after selecting "1" using \wedge or \vee and pressing \odot , it is available to change P.I.D value in zone "1". ("2" and "3" are same as "1")

When integral time is OFF, manual reset mode is indicated and then you could set reset value to remove off set. (range: -5 % ~ 105.0 % of proportional band). You could set 3 zones by selecting zone mode ON.

■ Alarm group setting (Optional)

There are 2 alarm outputs available per controller. In Alarm Group, setting are made for mode, dead band and value of each alarm. Refer to the next page for the 20 different types of alarm functions.

Signal	Name	Description	Condition	Initial value
\odot GAL	Alarm group	Set alarm mode	Optional	—
\odot A1TY	Type of Alarm 1	OFF / 1 ~ 22 Refer to "Alarm type and code"	Always	1
A2TY	Type of Alarm 2			2
\odot A1db	Dead band of Alarm 1	EUS (0.0 ~ 100.0 %)	Always	EUS(0.5%)
\odot A2db	Dead band of Alarm 2			
AL-1	Set value of Alarm 1	PV alarm, Deviation alarm: EU (-100.0 ~ 100.0 %)	Always	EU(100.0%) EU(0.0%)
\odot AL-2	Set value of Alarm 2			

※ Reference : Display lamp will be OFF when output ON in inverted type.



ALARM TYPE AND CODE

(Notice) : Display lamp will be ON when output OFF in inverted type.

Hysteresis (△ : Set point , -▲ : Minus Alarm set point , ▲ : Alarm set point)

Code NO.	Alarm type	Function
1	High absolute value	
2	Low absolute value	
* 3	High deviation value	
* 4	Low deviation value	
* 5	High deviation value (inverted)	
* 6	Low deviation value (inverted)	
* 7	High · Low deviation value	
* 8	High · Low band	
9	High absolute (inverted)	
10	Low absolute (inverted)	
11	High absolute with hold function	
12	Low absolute with hold function	
* 13	High deviation with hold function	
* 14	Low deviation with hold function	
* 15	High deviation with hold function (inverted)	
* 16	Low deviation with hold function (inverted)	
* 17	High · Low deviation with hold function	
* 18	High · Low band with hold function	
19	High absolute value with hold function (inverted)	
20	Low absolute value with hold function (inverted)	

*Marked alarms are not available in RT9-0

■ Communication group setting (Optional)

RT9 series is equipped with 4 wire / 2 wire half-duplex the RS485 / RS422 communication interfaces. Using the interfaces, communications are available with maximum 31 devices.

Signal	Name	Description	Condition	Initial value
	Communication group	Set communication mode	Optional	—
	RS485/RS422 Protocol	PC.LINK(Set value:0) / PC.LINK SUM (Set value:1)	Optional	0
	Communication rate (B.P.S)	600(SV:0) / 1200(SV:1) / 2400(SV:2) / 4800(SV:3) / 9600(SV:4)		4
	Parity check	NONE(SV:0) / EVEN(SV:1) / ODD(SV:2)		1
	Stop bit	1bit (SV:1) / 2bit (SV:2)		1
	Data length	7bit (SV:7) / 8bit (SV:8) (Except PC LINK :8)		8
	Address	1 ~ 99, maximum 31 devices		1
	Response time	0 ~ 10. response time = (handling time + response time) X 10 ms		0

■ Output group setting (Model : RT9-1)

Signal	Name	Description	Condition	Initial value
	Output group	Output type and mode selection	Model:RT9-1	—
	Output signal	Refer to type of control output	Always	3
	Output operation	REV: Reverse DIR: Direct action	Always	REV
	Cycle time	1 ~ 1000 sec	Relay / SSR	30 sec
	Hysteresis	EUS(0.0 ~ 100.0 %)	ON/OFF Control	0
	Output volume when input disconnection Output (Out)	-5.0 ~ 105.0 %	Always	0.0 %
	Maximum value of output	OL-L + 1 Digit ~ 105.0 %	Except ON/OFF	100.0 %
	Minimum value of output	-0.5 % ~ OL-H-1 Digit	Except ON/OFF	0.0 %

⚠ CAUTION

When setting, “**Input type selection number**” must be selected in the input type selection mode and also “**Output type selection number**” must be selected in the output type selection mode before moving to other mode.

If not, data of other group will be changed to prior value.

Output is selectable among Relay, SSR and Current(4 ~ 20 mA DC).

For Recorder & Controller, output code 0 ~ 3 are available for your use.

■ Input group setting

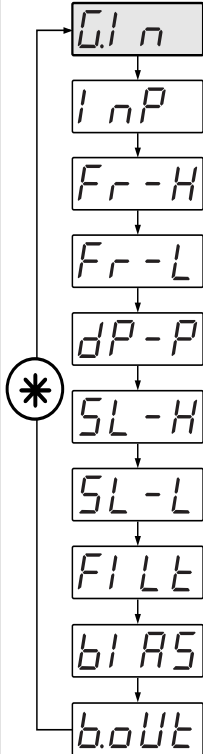
Signal	Name	Description	Condition	Initial value
	Input group	Input type and mode selection	Always	—
	Input signal selection	Refer to input signal and range	Always	Selection NO.1
	High limit	Refer to input signal and range (Notice : FR-H > FR-L)	Always	1370
	Low limit		Always	-200
	Decimal point (on voltage input)	Thermocouple or R.T.D : Not available DC Voltage : 0~3	On voltage input (mV,V)	1
	Maximum on scale (on voltage input)	-1999~9999 Notice : SL-H > SL-L Deimal point : according to DP-P	On voltage input (mV,V)	100.0
	Minimum on scale (on voltage input)			0.0
	PV filter	OFF/1~120sec	Always	OFF
	PV bias	EUS (-100.0~100.0%)	Always	EUS(0.0 %)
	Burn-out	OFF / UP / DOWN	Always	UP



⚠ CAUTION

When setting, “**Input type selection number**” must be selected in the input type selection mode and also “**Output type selection number**” must be selected in the output type selection mode before moving to other mode.

If not, data of other group will be changed to prior value.

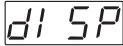

● Input type selection

After power ON and when PV is indicating, press  key for 3 sec to be displayed  at PV and 3 at SV. (If it is not indicated 3, set again in the level setting mode)

Control group is indicated when press  key once more. At the time, input group is indicated when press  key and then “Input type and range selection is shown at SV when press .

At this time the input and range is selected by  or  key. Press  key to confirm

● Maximum and Minimum range

Press  key to set Maximum and Minimum range using ,

 or  key. Press  key once more to finish.

● Decimal point

Parameter is not indicated in T.C and R.T.D input, but when selecting voltage input “Decimal point” mode is indicated. (set 1 : 0.0, set 2 : 0.00, set 3 : 0.000)

● Maximum and Minimum on scale

It is the same function as Maximum and Minimum Range setting when R.T.D or thermocouple input. This mode is indicated when voltage input (30, 31, 32, 33)

●PV filter

When PV value becomes unstable due to effects of noise, the filter helps suppress the unstable status. (Range: OFF or 1 ~ 120 sec. initial value: OFF)



●PV bias

Use this function to adjust PV value in cases where it is necessary for PV value to agree with another recorder or indicator, or when the sensor cannot be mounted in correct location.

(Range : -100.0 ~ 100.0 % of SPAN, Initial value : 0.0 %)

Setting a value using ◀ , ▼ or ▲ key and press * key to finish.

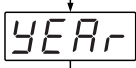
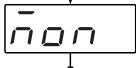
■ Time group setting

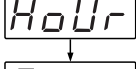
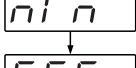
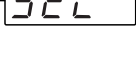
Signal	Name	Description	Condition	Initial value
	Time group	Set Y, M, D, T.	Always	—
	Set Year	2000 ~ 2099	Always	Present value
	Set Month	1 ~ 12	Always	Present value
	Set Day	1 ~ 31	Always	Present value
	Set Hour	0 ~ 23	Always	Present value
	Set Minute	0 ~ 59	Always	Present value
	Set Second	0 ~ 59	Always	Present value

■ AUTO TUNING

The Auto tuning function automatically measures, computes and sets the optimum Proportional band(P), Integral time(I), and Derivative time(D). When Auto-tuning, the controller performs ON/OFF control and determine proper P.I and D. (Limit cycle type) RT9-1 series have two types of Auto-tuning as below.

- Standard type auto-tuning :
This type is based on set point value (SV)
- Low PV type auto-tuning :
This type is based on the value 10 % lower than the set point value (SV)

● STANDARD TYPE AUTO-TUNING

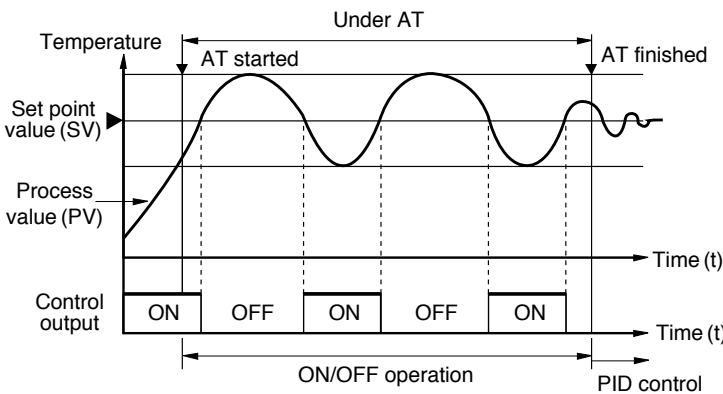

● LOW PV TYPE AUTO-TUNING

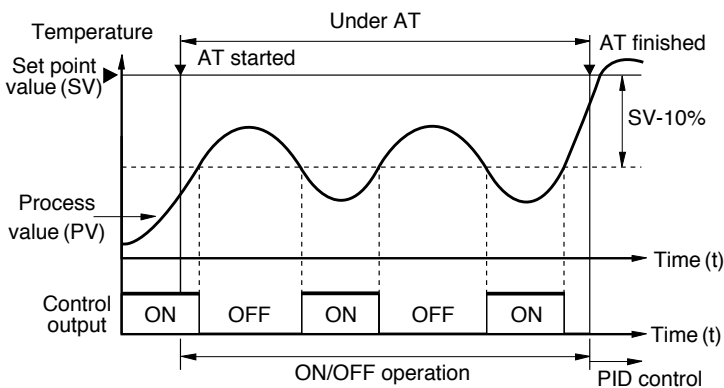

■ Auto-tuning in Zone PID

Zone PID automatically sets PID group in accordance with a measured value. In Zone PID, auto-tuning sets the proper PID value by recognizing a mid-value of reference point as set point value.

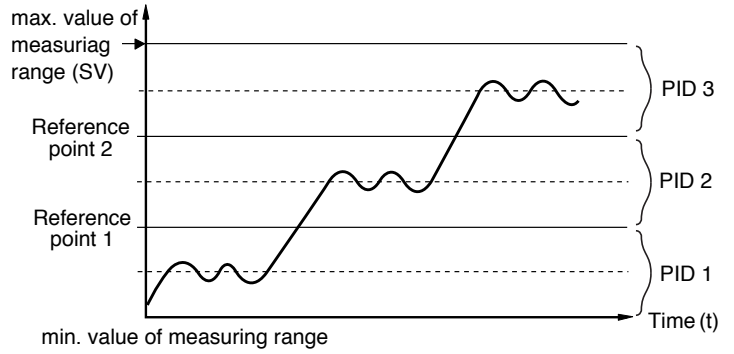

■ RAMP FUNCTION

It is a rate of set value to arrive to set value according to setting temperature and time.
ex) Present temp. 20 °C, set value 100 °C, 20 °C per min.

- Initial uprising set value(up,rt) : 100 °C
- Unit time : Minute (min)

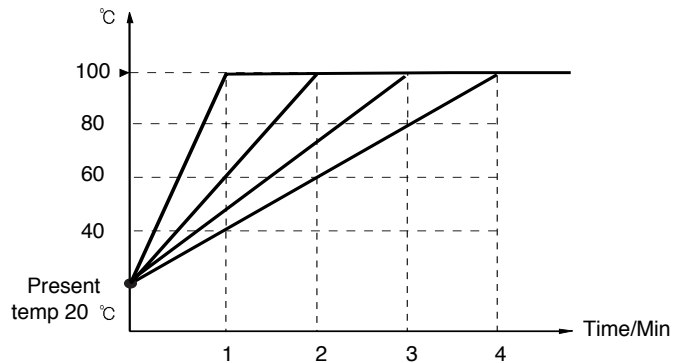

■ ZOOM FUNCTION

When you choose Zoom function ON in Group control, you can see a temperature with zooming as soon as you select ON. The temperature will be in the center of paper.

- ex) Scale : 0.0 ~ 100.0 °C
- Zoom ON : ZOOM IN » PV : 25.2 °C at the center

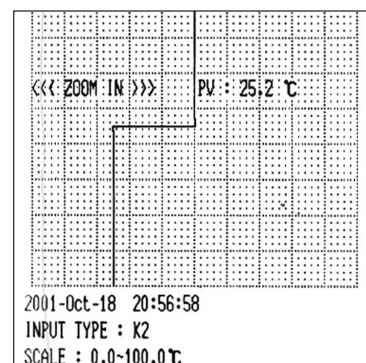

■ FUZZY CONTROL

Fuzzy control eliminates overshoot using Fuzzy Logic. Employing Fuzzy control and Auto-tuning, the controller effectively control as below.

- When the controller starts control at the position which has a big gap between SV and PV.
- When reducing warming up time
- When the load is fluctuating extremly
- When changing a set point value frequently

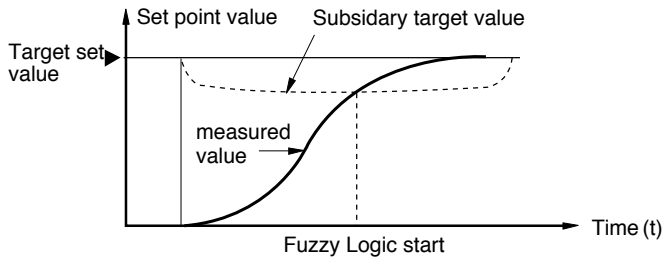

■ OUTPUT LIMIT

Control output is set in high and low limit as operating range.

Output limit is -5 ~ 105 % of output.

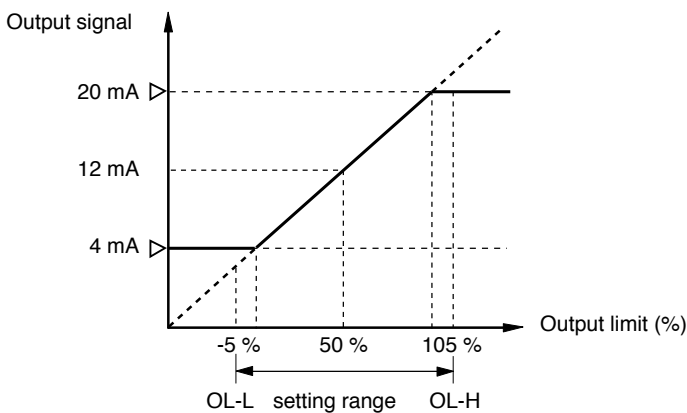

■ Emergency output

When A/D error or input disconnection occur in auto mode, PID output is cut and than Pre-set output is operated. (PO Output)

■ HOLD FUNCTION

Without hold function, Low limit alarm will be ON when increasing temperature. (Picture 1)

● Hold function : None

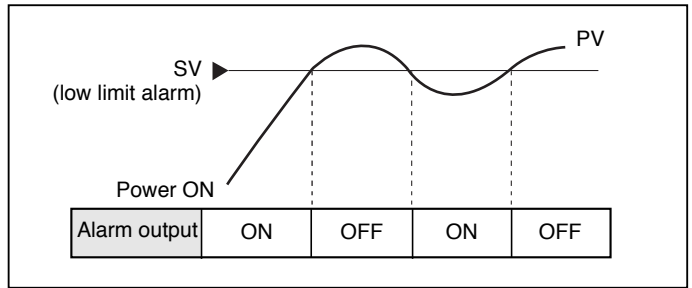

(Picture 1)

● Hold function

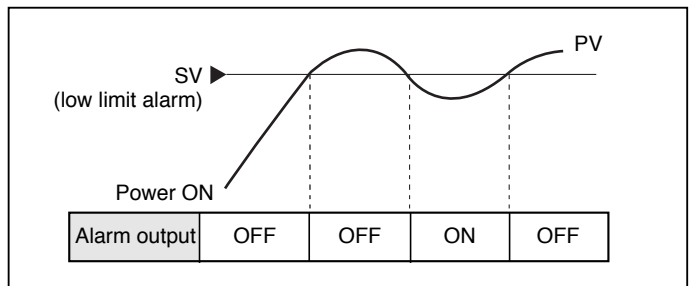

(Picture 2)

■ RECORDER

- Run/Stop : You can record or stop when you need.
- Feed : Paper can be transmitted forcedly.
- Graphic or Text selectable

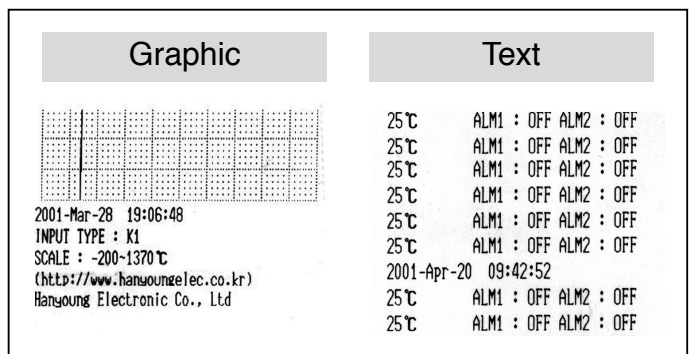

- List printing : You can check and keep an important data which is set in each parameter.

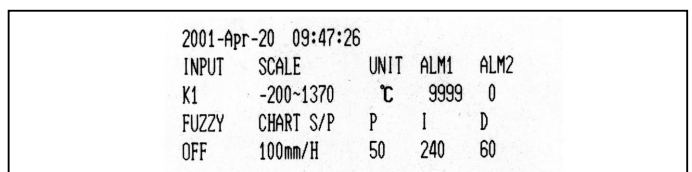

MEMO

HALYOUNG

HAPOUNG

#1381-3, Juan-dong, Nam-gu, Incheon, Korea
TEL:(82-32) 876-4697 FAX:(82-32) 876-4696
<http://www.hynux.com> E-mail: sdt@hyelec.co.kr