

# Solenoid Coil Series CHAPTER 08

- A Wide Range of Option
- Various Voltage Specification
- 15mm Coil Width
- 22mm Coil Width



SC1-\*\*\*  
IP65(With Connector)



SC2-\*\*\*  
IP65(With Connector)



SG1-\*\*\*  
IP65



SG2-\*\*\*  
IP65



SD1-\*\*\*  
IP42  
Indicator : LED



SD2-\*\*\*  
IP42  
Indicator : LED



SL1-\*\*\*  
IP42  
Indicator : LED



SM1-\*\*\*  
IP42  
Indicator : LED

\*\*\*: Voltage Selection

## SPECIFICATION

ITEM	FUNCTION	SOLENOID COIL		
		SC1	SC2	
Voltage Tolerances		±10% of Rated Voltage		
Coil Insulation Class		F-Class or Equivalent		
Temperature Range		5~60°C (41~140°F)		
Holding Power	AC	60Hz	3.5VA	5.5VA
		50Hz	4.5VA	6.5VA
	DC	2.5W	2.5W	

### The Material of Parts

- Molding : Glass Pressure Nylon
- Lead Wire : AWG-no.22, no.24
- Lead Wire Packing : Viton
- Yoke : Carbon Iron
- Indicator Cap : Polycarbonate

※ The specification on each item can be amended without any prenotice to improve a performance.  
 ※ The specification on each item can be different from actual specification.

## ORDERING NO.

SC1 - A2

Solenoid Coil Type	
SC1	15mm-3 Pin Connector Coil
SG1	15mm-Grommet/Flying Leads
SD1	15mm-Grommet/Flying Leads With LED
SL1	15mm-90 Degree Plug-in Wire Assembly LED
SM1	15mm-180 Degree Plug-in Wire Assembly LED
SC2	22mm-3 Pin Connector Coil
SG2	22mm-Grommet/Flying Leads
SD2	22mm-Grommet/Flying Leads With LED

Voltage	
A2	AC 220V
A1	AC 110V
A4	AC 24V
D4	DC 24V
D2	DC 12V

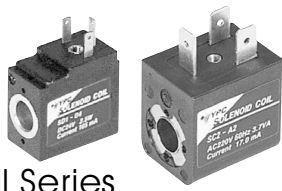
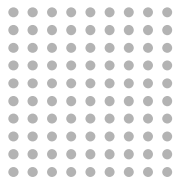

# Solenoid Coil Series

# 15mm Width / 22mm Width

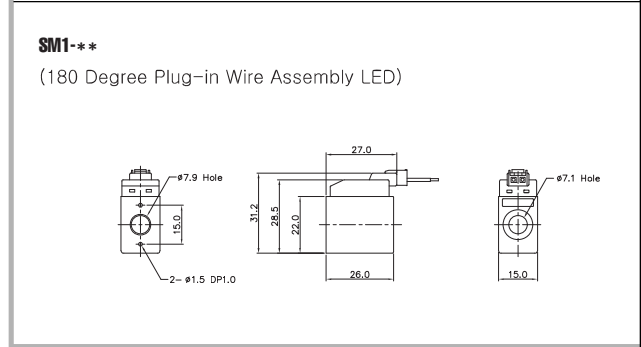
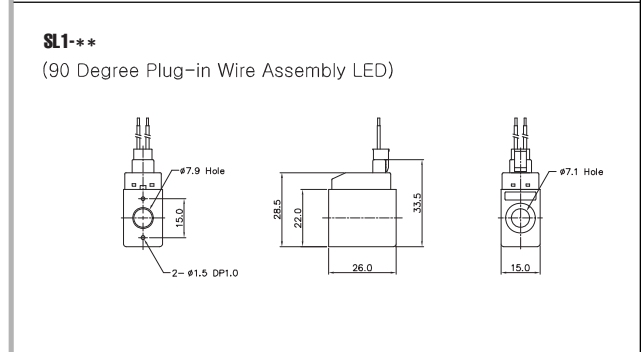
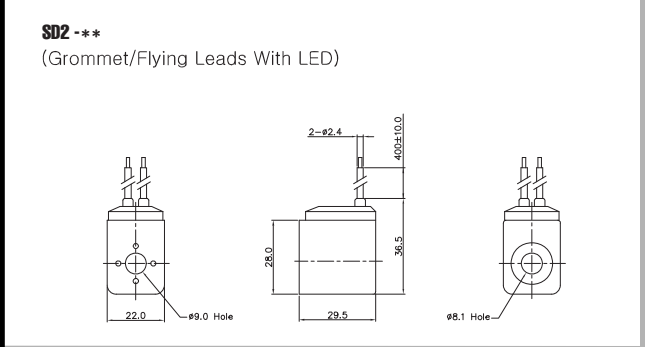
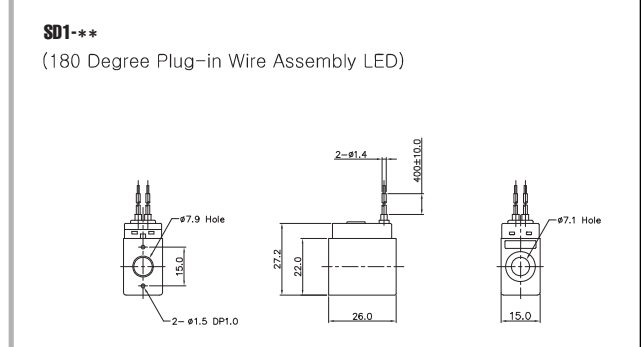
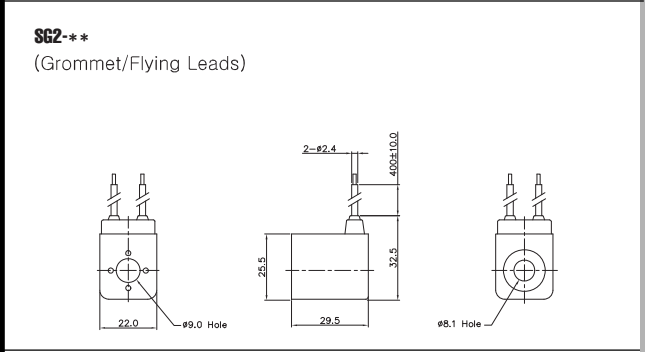
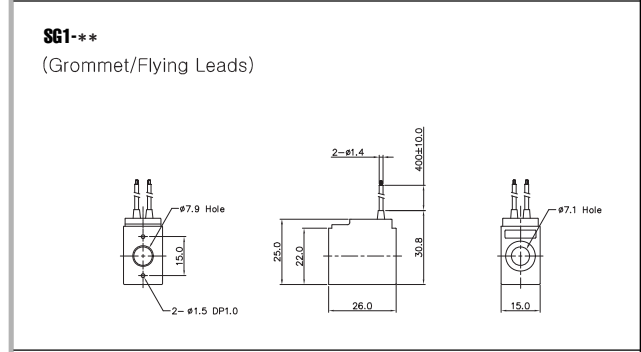
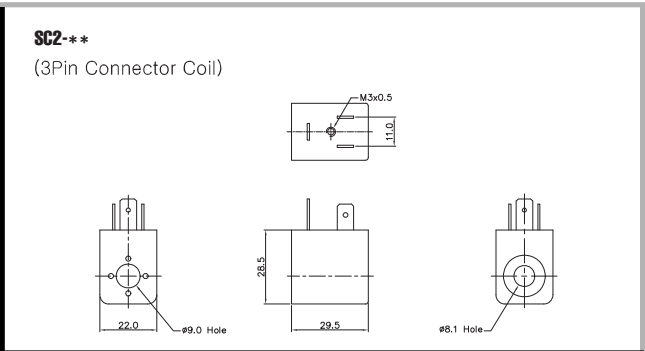
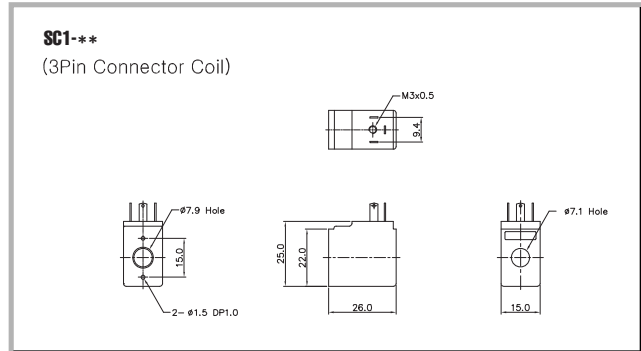

# DIN Connector Series

- A Wide Range of Option
- Various Voltage Specification
- 15mm Coil Width
- 22mm Coil Width

## SPECIFICATION

ITEM	FUNCTION	Connector	
		CN1	CN2
Voltage Tolerances		±10% of Rated Voltage	
Temperature Range		5~60°C (41~140°F)	
Max. Current		2.5A	
Protection Class		IP65(With Coil)	
Section Conductance		Max. 0.75mm <sup>2</sup>	Max. 1.50mm <sup>2</sup>

### The Material of Parts

- Indicator : Glass Pressure Nylon, Polycarbonate
- Sealing Packing : NBR
- Jointing Bolt : Carbon Iron

\* The specification on each item can be amended without any prenotice to improve a performance.  
 \* The specification on each item can be different from actual specification.

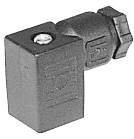

CN1



CN2



CD1-\*\*



CD2-\*\*



CZ1



CZ2

\*\* : Voltage Selection

## ORDERING NO.

CD1 - A2

Connector Type	
CN1	15mm-3 Pin Normal Connector
CD1	15mm-3 Pin Connector With LED
CZ1	15mm-3 Pin Connector With LED & Surge Suppressor
CN2	22mm-3 Pin Normal Connector
CD2	22mm-3 Pin Connector With LED
CZ2	22mm-3 Pin Connector With LED & Surge Suppressor
CNM2	24mm-3 Pin Metal Normal Connector
CDM2	24mm-3 Pin Metal Connector With LED
CZM2	24mm-3 Pin Metal Connector With LED & Surge Suppressor

Voltage	
A2	AC 220V
A1	AC 110V
A4	AC 24V
D4	DC 24V
D2	DC 12V

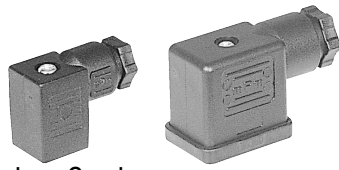
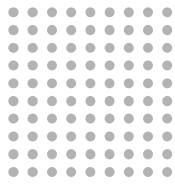

# DIN Connector Series

# 15mm Width / 22mm Width

**CN1**  
(Normal Connector)

**CD1-\*\***  
(Connector With Connector)

**CZ1-\*\***  
(Connector With Connector & Surge Suppressor)

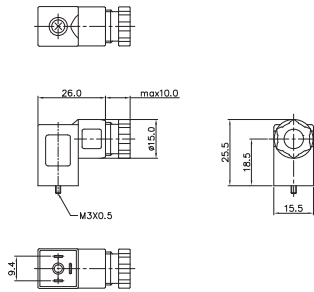

**CN2**  
(Normal Connector)

**CD2-\*\***  
(Connector With Connector)

**CZ2-\*\***  
(Connector With Connector & Surge Suppressor)

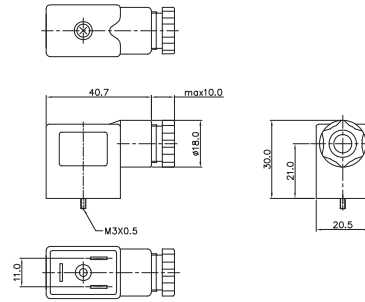

**CNM2**  
Metal Connector

**CDM2-\*\***  
Metal Connector With LED

**CZM2-\*\***  
Metal Connector With LED & Surge Suppressor

