

SF6000. 1/2

"F" FLEXIBLE Series
Solenoid / Pneumatic Valves

- 5/2, 5/3 - 1/2
- 36mm Body Width
- Transition Flow 3500ℓ/min (5bar)

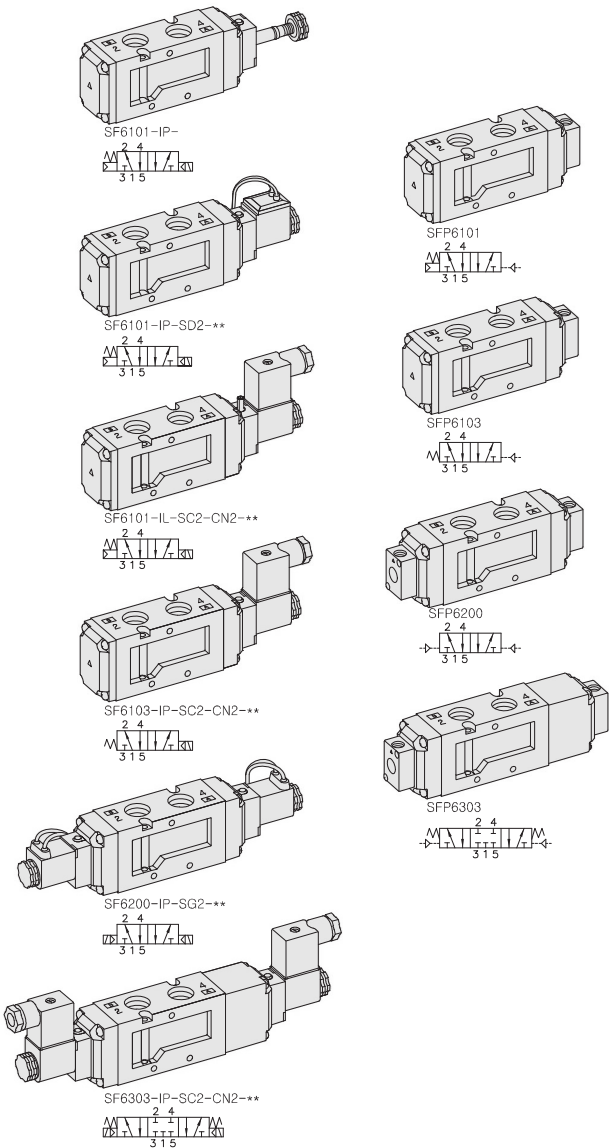

** : Voltage Selection (see page 80)

SPECIFICATION

ITEM	SERIES	SOLENOID, PNEUMATIC	
	FUNCTION	5 Port 2 Position	5 Port 3 Position
Fluids		Compressed Air & Inert Gases	
Pressure(bar)		1.5~10.0	2.0~10.0
Eff. Section Area(mm ²)-5bar		65.0	50.0
Ambient & Fluid Temp.		5~60°C(41~140°F)	
Response Time(5bar)		30ms or Less	40ms or Less
Max. Working Frequency		2c/sec	1c/sec
Lubrication		Not Required(Use ISO VG32#)	
Manual Override		Push Button(Standard), Lever Lock(Optional)	
Coil Insulation Class		F-Class or Equivalent	
Permissible Voltage Variation		±10% of Rated Voltage	
Off Min. Residual Voltage		AC:20% or Less / DC:10% or Less	
Power Consumption		Holding-AC:5.5VA(60Hz) / DC:2.5W	

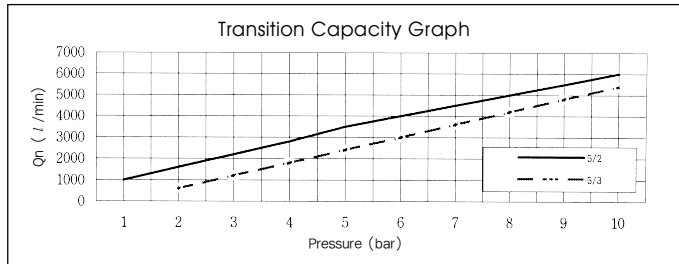

The Material of Parts

- Valve Body : Die-Cast Aluminium
- Pilot Parts : Glass Filled Nylon
- Spool : Aluminium
- Armature : Stainless Steel
- Seals : NBR
- Armature Seals : Viton
- Spring : Stainless
- Cap : Zinc Pressure Die-Cast

* The specification on each item can be amended without any prenotice to improve a performance.
* The specification on each item can be different from actual specification.

ORDERING NO.

SF6 1 0 1 - I P - SC2 - CN2 - A2

Valve Series	Function	Port Size & Thread	Return Method	Int/Ext. Pilot	Manual Operator	Solenoid Coil Type	Connector Type	Voltage
SF6 : Solenoid Valve	1 5/2 Single	0 G 1/2	0 None	I Internal Pilot	0 None	0 None	0 None	0 None
	2 5/2 Double	1 NPT 1/2	1 Air + Spring		P Push Non-Locking	SC2 3 Pin Connector Coil	CN2 Normal Connector	A2 AC 220V
	3 5/3 Closed Center		2 Air		L Lever Locking	SG2 Grommet/Flying Leads	CD2 Connector With LED	A1 AC 110V
SFP6 : Pneumatic Valve	4 5/3 Open Center		2 Air			CZ2 Connector With LED	A4 AC 24V	A4 AC 24V
	5 5/3 Pressure Center		3 Spring			SD2 Grommet/Flying Leads With LED	& Surge Suppressor	D4 DC 24V
								D2 DC 12V

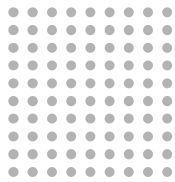

Solenoid & Pilot Actuated Spool Valves

Port Thread 1/2

5Port 2Position Solenoid Valve

Single Solenoid
SF6101-IP-SD2-***

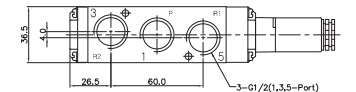
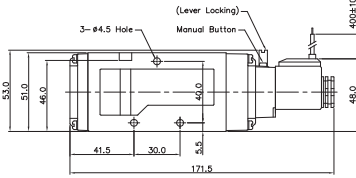
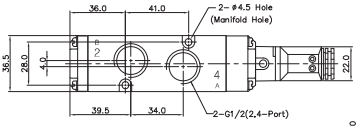

Double Solenoid
SF6200-IP-SC2-CN2-***

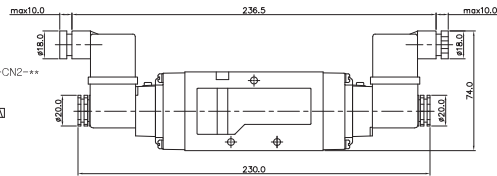

5Port 3Position Solenoid Valve

Closed Center
SF6303-IP-SC2-CN2-***

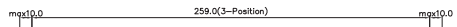
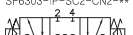

Exhaust Center
SF6403-IP-SC2-CN2-***

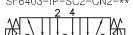

Pressure Center
SF6503-IP-SC2-CN2-***

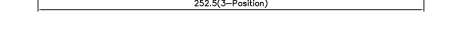
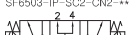

5Port 2Position Pneumatic Valve

Single Pneumatic
SFP6101

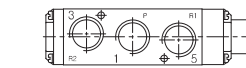
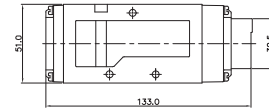
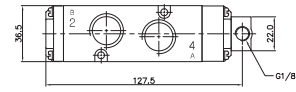
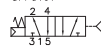

Double Pneumatic
SFP6200

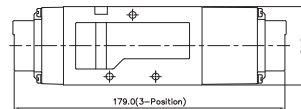
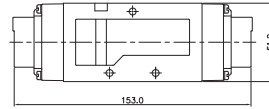
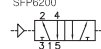

5Port 3Position Pneumatic Valve

Closed Center
SFP6303

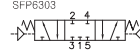

Exhaust Center
SFP6403

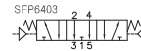

Pressure Center
SFP6503

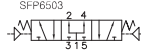

MF6000 MANIFOLD BLOCK

(SF6000 Solenoid & Pneumatic Valve Use)

Manifold Block Ordering Code

MF 6500		-		2	
Series	Manifold Station				
MF6500	5 Way	02	2-Station		
		04	4-Station		
		06	6-Station		
		08	8-Station		
		10	10-Station		

Blanking Plate Ordering Code

MF6500-BLK	
	Blanking Plate. (Material: SCP1)
	Gasket O-Ring (Material: NBR)

5-Port Manifold Block

MF6500-4

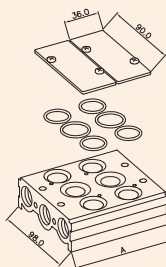

MF6500-BLK
Blanking Plate
Gasket O-Ring

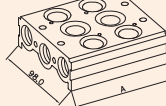

MF6500-02
Manifold Block

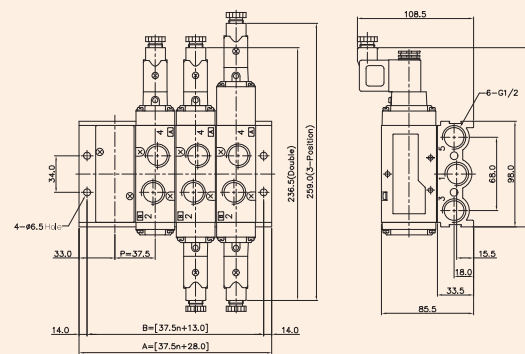
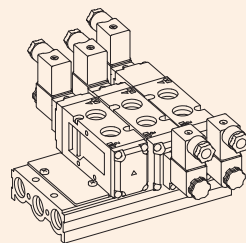

5PORT MANIFOLD BLOCK DIMENSION					n=STATION
MIN	2	4	6	8	10
B	85.0	163.0	238.0	313.0	388.0
A	103.0	178.0	253.0	328.0	403.0