

BJ Series

Compact and Long Sensing Distance Type

■ Features

■ Long distance sensing type

- High performance lens with long sensing distance
 - Through-beam type: 15m
 - Diffuse reflective type: 1m
 - Polarized retroreflective type: 3m (MS-2A)
- M.S.R. (Mirror Surface Rejection) function (polarized retroreflective type) for detecting mirrors or highly reflective targets
- Compact size: W10.6 × H32 × L20mm
- Light ON/Dark ON operation mode switch
- Sensitivity adjuster
- Built-in reverse polarity protection circuit and output short overcurrent protection circuit
- Mutual interference prevention function (except through-beam type)
- Excellent noise immunity and minimal influence from ambient light
- IP65 protection structure (IEC standard) / IP67 for BJ-C connector types

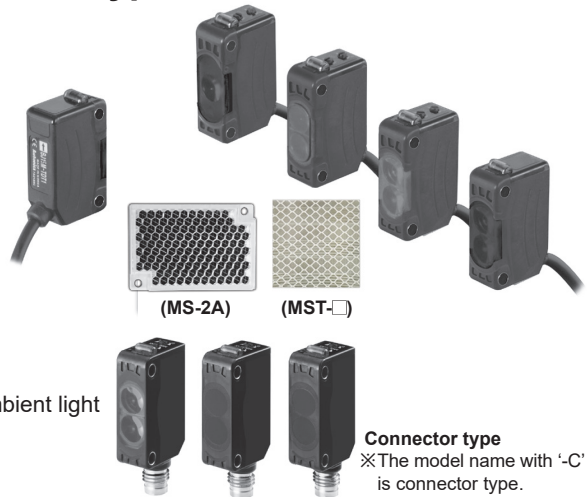

Connector type

- ※The model name with 'C' is connector type.
- ※MST-□ is sold separately.

⚠ Please read "Safety Considerations" in the instruction manual before using.



■ Specifications

Type	Long distance sensing type							
Model	NPN open collector output	BJ15M-TDT	BJ10M-TDT	BJ7M-TDT	BJ3M-PDT	BJ1M-DDT	BJ300-DDT	BJ100-DDT
	PNP open collector output	BJ15M-TDT-C	BJ10M-TDT-C	BJ7M-TDT-C	BJ3M-PDT-C	BJ1M-DDT-C	BJ300-DDT-C	BJ100-DDT-C
Model	NPN open collector output	BJ15M-TDT-P	BJ10M-TDT-P	BJ7M-TDT-P	BJ3M-PDT-P	BJ1M-DDT-P	BJ300-DDT-P	BJ100-DDT-P
	PNP open collector output	BJ15M-TDT-C-P	BJ10M-TDT-C-P	BJ7M-TDT-C-P	BJ3M-PDT-C-P	BJ1M-DDT-C-P	BJ300-DDT-C-P	BJ100-DDT-C-P
Sensing type	Through-beam				Polarized retroreflective type	Diffuse reflective		
Sensing distance	15m	10m	7m	3m ^{※1}	1m ^{※2}	300mm ^{※3}	100mm ^{※3}	
Sensing target	Opaque material of min. Ø12mm		Opaque material of min. Ø8mm	Opaque material of min. Ø75mm	Translucent, opaque materials			
Hysteresis	—							
Response time	Max. 1ms							
Power supply	12-24VDC \pm 10% (ripple P-P: max.10%)							
Current consumption	Emitter/Receiver: Max. 20mA				Max. 30mA			
Light source	Infrared LED (850nm)	Red LED (660nm)	Red LED (650nm)	Red LED (660nm)	Infrared LED (850nm)	Red LED (660nm)	Infrared LED (850nm)	
Sensitivity adjustment	Sensitivity adjuster							
Operation mode	Light ON/Dark ON operation mode switch							
Control output	NPN or PNP open collector output ●Load voltage: max. 26.4VDC \pm ●Load current: max. 100mA ●Residual voltage - NPN: max. 1VDC \pm , PNP: max. 2.5VDC							
Protection circuit	Reverse polarity protection circuit, output short overcurrent protection circuit, mutual interference prevention function (except through-beam type)							
Indicator	Operation indicator: red LED, stable indicator: green LED (emitter's power indicator: green)							
Insulation resistance	Over 20MΩ (at 500VDC megger)							
Noise immunity	\pm 240V the square wave noise (pulse width:1μs) by the noise simulator							
Dielectric strength	1000VAC 50/60Hz for 1minute							
Vibration	1.5mm amplitude at frequency of 10 to 55Hz (for 1 min) in each X, Y, Z direction for 2 hours							
Shock	500m/s ² (approx. 50G) in each X, Y, Z direction for 3 times							
Environment	Ambient illumination	Sunlight: max. 11,000lx, incandescent lamp: max. 3,000lx (receiver illumination)						
	Ambient temperature	-25 to 55°C, storage: -40 to 70°C						
	Ambient humidity	35 to 85%RH, storage: 35 to 85%RH						
Protection structure	BJ: IP65 (IEC standard), BJ-C: IP67 (IEC standard)							
Material	Case: polycarbonate+acrylonitrile butadiene styrene, LED cap: polycarbonate, sensing part: polymethyl methacrylate, bracket: SUS304 (steel use stainless 304), bolt, nut: steel chromium molybdenum, sleeve: brass, ni-plate							
Cable ^{※4}	BJ: Ø3.5mm, 3-wire, 2m (emitter of through-beam type: Ø3.5mm, 2-wire, 2m) (AWG24, core diameter: 0.08mm, number of cores: 40, insulator out diameter: Ø1mm)							
Accessory	Common	Fixing bracket ^{※5} , M3 bolt: 4, M3 nut: 4, adjustment screwdriver			Fixing bracket ^{※5} , M3 bolt: 2, M3 nut: 2, adjustment screwdriver			
	Individual	—			Reflector (MS-2A) —			
Approval	CE							
Weight ^{※6}	BJ: approx. 115g (approx. 90g) BJ-C: approx. 45g (approx. 20g)				BJ: approx. 85g (approx. 60g) BJ-C: approx. 55g (approx. 30g)		BJ: approx. 70g (approx. 45g) BJ-C: approx. 35g (approx. 10g)	

※1: The sensing distance is specified with the MS-2A reflector. The distance between the sensor and the reflector should be set over 0.1m.
The sensing distance is extended from 0.1 to 4m or 0.1 to 5m when using optional reflector MS-2S or MS-3S.
When using reflective tapes, the reflectivity will vary by the size of the tape. Please refer to the "■ Reflectivity By Reflective Tape Model" table before using the tapes.
※2: Non-glossy white paper 300×300mm. ※3: Non-glossy white paper 100×100mm.
※4: M8 connector cable is sold separately. (cable - AWG22, Core diameter: 0.08mm, Number of cores: 60, Insulator out diameter: Ø1.25mm)
※5: Cable type includes bracket A and connector type includes bracket B. ※6: The weight includes packaging. The weight in parenthesis is for unit only.
※The temperature or humidity mentioned in Environment indicates a non freezing or condensation environment.

Long Sensing Distance/BGS Reflective/Micro Spot Type

Transparent Glass Sensing/BGS Reflective/Micro Spot Type

■ Features

■ BGS reflective type

- BGS (background suppression) minimizes detection errors from background objects and the color or material of target objects. Also the detecting distance can be configured with the sensitivity adjuster.
- Visible light source allows users to identify the sensing area, and the tiny spot size minimizes influence from surrounding objects

■ Transparent glass sensing type / Micro spot type

- Stable detection of transparent targets (LCD, PDP, glass etc.) (transparent glass sensing types)
- Check sensing area with visible micro spot (micro spot types)
- Detect tiny objects (minimum target size: Ø0.2mm copper wire)

■ Commonness

- Compact size: W10.6 × H32 × L20mm
- Light ON/Dark ON operation mode switch (except BJG30-DDT)
- Sensitivity adjuster (except BJG3-DDT)
- Built-in reverse polarity protection circuit and output short overcurrent protection circuit
- Mutual interference prevention function (except BGS reflective type)
- Excellent noise immunity and minimal influence from ambient light
- IP65 protection structure (IEC standard)

⚠ Please read "Safety Considerations" in the instruction manual before using.

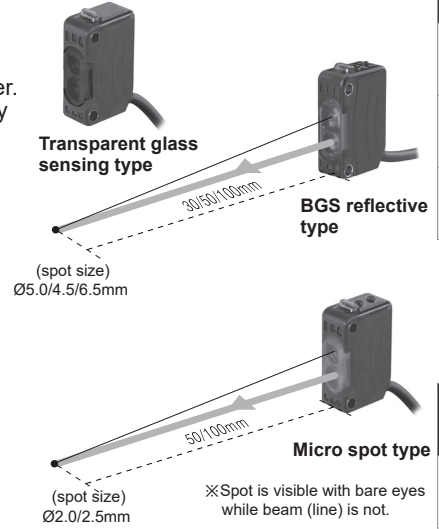

■ Specifications

Type	Transparent glass sensing type		BGS reflective type ^{※1}		Micro spot type	
Model	BJG30-DDT		BJ30-BDT	BJ50-BDT	BJN50-NDT	BJN100-NDT
	—		BJ30-BDT-P	BJ50-BDT-P	BJN50-NDT-P	BJN100-NDT-P
Sensing type	Diffuse reflective		BGS reflective		Narrow beam reflective	
Sensing distance	30mm ^{※2}	15mm ^{※3}	10 to 30mm ^{※4}	10 to 50mm ^{※4}	30 to 70mm	70 to 130mm
Sensing target	Transparent glass, opaque materials, translucent		Translucent, opaque materials		Translucent, opaque materials	
Min. diameter of transmitting spot	—		Approx. Ø5.0mm	Approx. Ø4.5mm	Approx. Ø2.0mm	Approx. Ø2.5mm
Min. sensing target	—		—		Approx. min. Ø0.2mm (copper wire)	
Hysteresis	Max. 20% at sensing distance		Max. 10% at sensing distance		Max. 25% at sensing distance	Max. 20% at sensing distance
Response time	Max. 1ms		Max. 1.5ms		Max. 1ms	
Power supply	12-24VDC [≡] ±10% (ripple P-P: max.10%)					
Current consumption	Max. 30mA					
Light source	Infrared LED (850nm)		Red LED (660nm)		Red LED (650nm)	
Sensitivity adjustment	—		Sensitivity adjuster			
Operation mode	Light ON fixed		Light ON/Dark ON operation mode switch			
Control output	NPN open collector output ●Load voltage: max. 26.4VDC [≡] ●Load current: max. 100mA ●Residual voltage: max. 1V		NPN or PNP open collector output ●Load voltage: max. 26.4VDC [≡] ●Residual voltage - NPN: max. 1VDC [≡] , PNP: min. 2.5VDC			
Protection circuit	Reverse polarity protection circuit, output short overcurrent protection circuit, mutual interference prevention function (except BGS reflective type)					
Indicator	Operation indicator: red LED, stability indicator: green LED					
Insulation resistance	Over 20MΩ (at 500VDC megger)					
Noise immunity	±240V the square wave noise (pulse width:1μs) by the noise simulator					
Dielectric strength	1,000VAC 50/60Hz for 1 min					
Vibration	1.5mm amplitude at frequency of 10 to 55Hz (for 1 min) in each X, Y, Z direction for 2 hours					
Shock	500m/s ² (approx. 50G) in each X, Y, Z direction for 3 times					
Environment	Ambient illumination	Sunlight: max. 11,000lx, incandescent lamp: max. 3,000lx (receiver illumination)				
	Ambient temperature	-25 to 55°C, storage: -40 to 70°C				
	Ambient humidity	35 to 85%RH, storage: 35 to 85%RH				
Protection structure	IP65 (IEC standard)					
Material	Case: polycarbonate+acrylonitrile butadiene styrene, LED cap: polycarbonate, sensing part: polymethyl methacrylate, bracket: SUS304 (steel use stainless 304), bolt, nut: steel chromium molybdenum, sleeve: brass, ni-plate					
Cable	Ø3.5mm, 3-wire, 2m (AWG24, core diameter: 0.08mm, number of cores: 40, insulator out diameter: Ø1mm)					
Accessory	Fixing bracket, M3 bolt: 2, M3 nut: 2		Fixing bracket, M3 bolt: 2, M3 nut: 2, adjustment screwdriver			
Approval	CE					
Unit weight	Approx. 45g		Approx. 50g		Approx. 45g	

※1: In case of BGS sensing type, black/white difference is max. 10% of sensing distance and sensitivity adjustment range is -10% of max. sensing distance (based on non-glossy white paper).

※2: Non-glossy white paper 100×100mm.

※3: Transparent glass 50×50mm, t=3.0mm.

※4: Non-glossy white paper 50×50mm.

※The temperature or humidity mentioned in Environment indicates a non freezing or condensation environment.

SENSORS

CONTROLLERS

MOTION DEVICES

SOFTWARE

(A) Photoelectric Sensors

(B) Fiber Optic Sensors

(C) LIDAR

(D) Door/Area Sensors

(E) Vision Sensors

(F) Proximity Sensors

(G) Pressure Sensors

(H) Rotary Encoders

(I) Connectors/ Connector Cables/ Sensor Distribution Boxes/ Sockets

BJ Series

■ Feature Data

◎ Through-beam type

● BJ15M-TDT- (C)- (P) / BJ10M-TDT- (C)- (P) / BJ7M-TDT- (P)

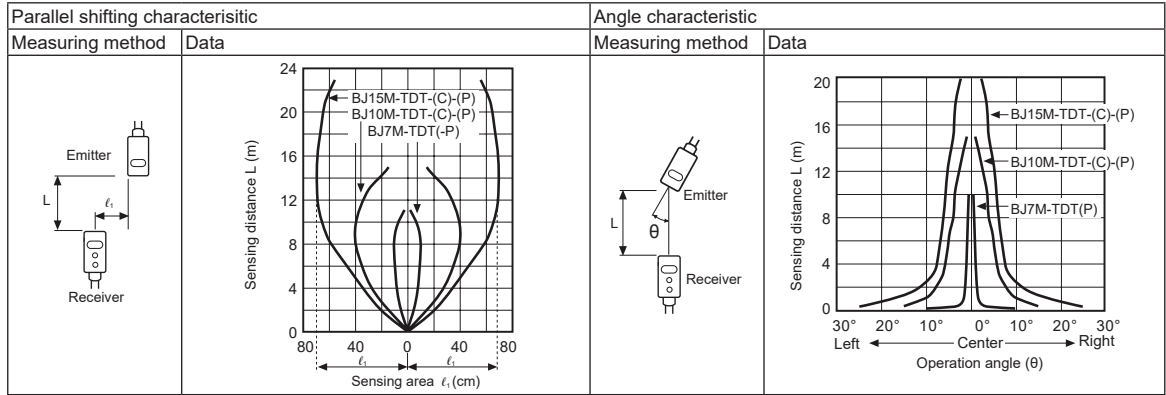

◎ Retroreflective type

● BJ3M-PDT- (C)- (P)

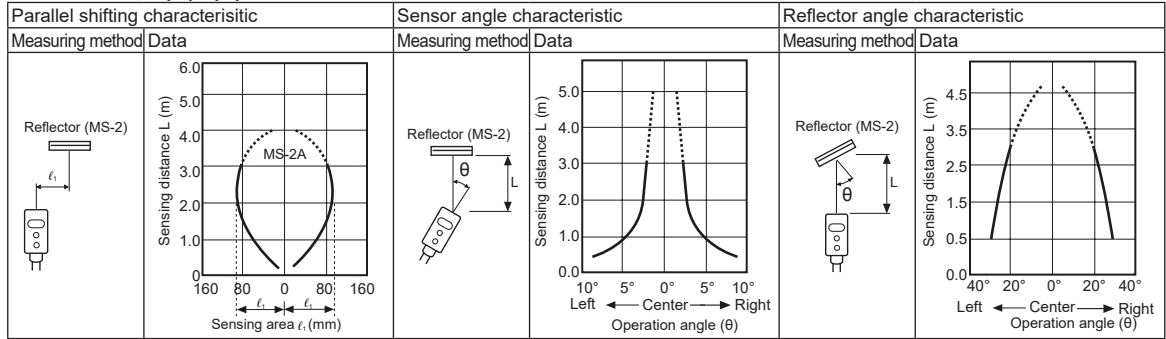

◎ Diffuse/Narrow beam reflective type

● BJ1M-DDT- (C)- (P)

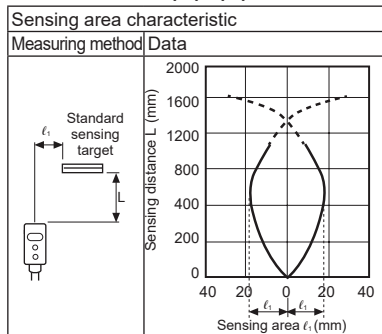

● BJ300-DDT- (C)- (P)

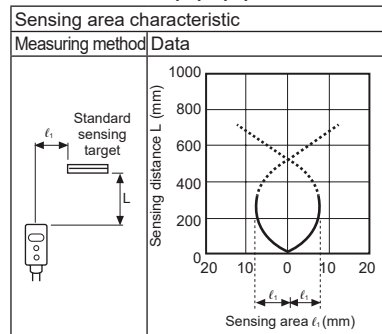

● BJ100-DDT- (C)- (P)

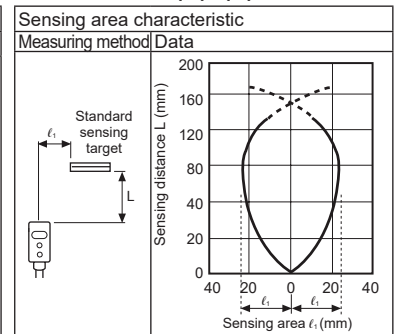

● BJG30-DDT

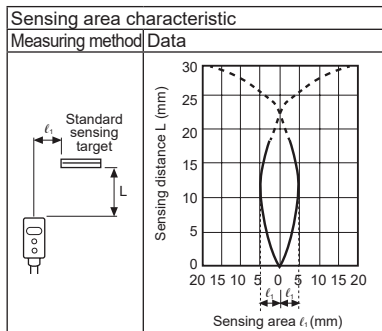

● BJN50-NDT- (P)

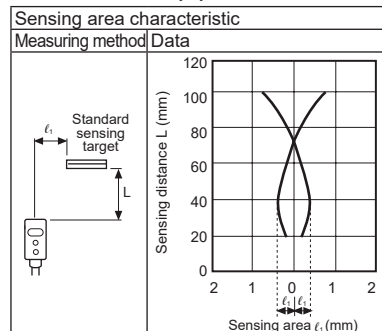

● BJN100-NDT- (P)

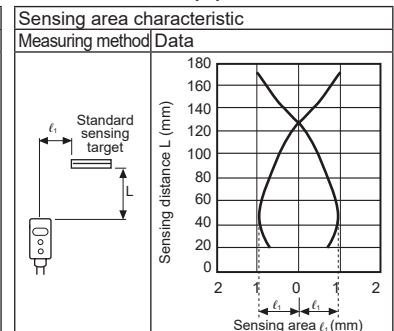

Long Sensing Distance/BGS Reflective/Micro Spot Type

Feature Data

◎ BGS reflective type

● BJ30-BDT / BJ30-BDT-P

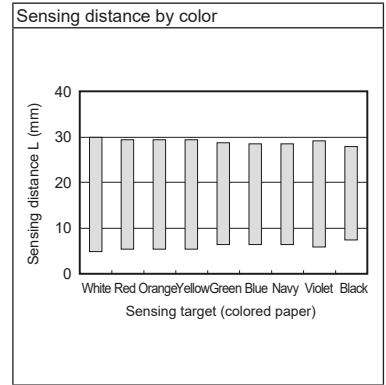
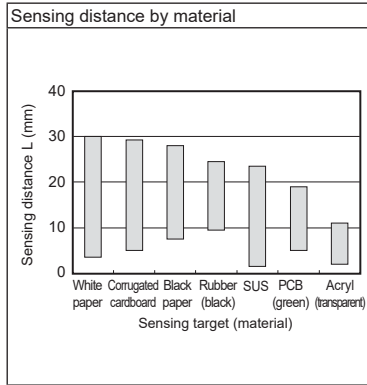
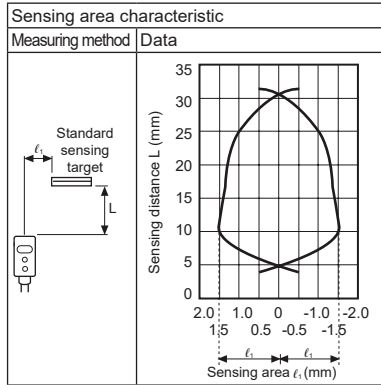

● BJ50-BDT / BJ50-BDT-P

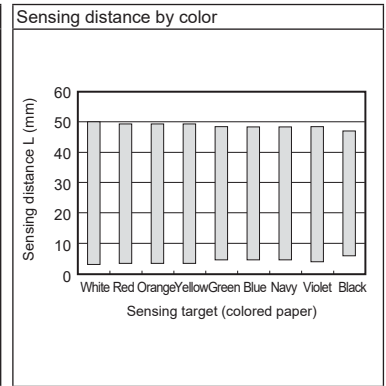
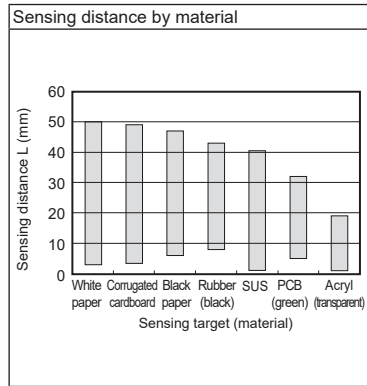
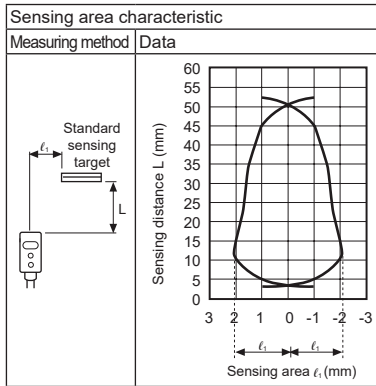

Connections

● Through-beam type

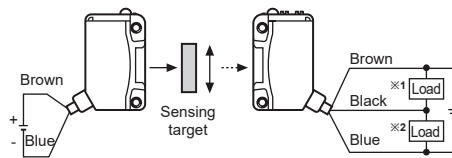

● Retroreflective type

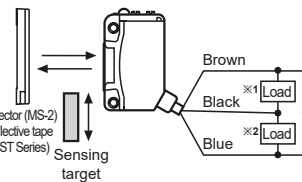

● Diffuse/Narrow beam/BGS reflective type

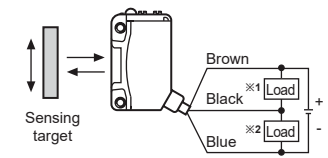

※1: Load connection for NPN output
 ※2: Load connection for PNP output

Connections for Connector Part

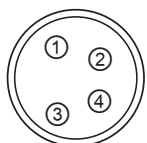

M8 Connector pin

Connector pin No.	Cable colors	Function
①	Brown	Power Source (+V)
②	White	—
③	Blue	Power Source (0V)
④	Black	Output

※Connector pin ② is N·C (not connected) terminal.

● Connector cable (sold separately)

※Connector cable model
 : CID408-□, CLD408-□
 ※Please refer to the connector cable section.

SENSORS

CONTROLLERS

MOTION DEVICES

SOFTWARE

(A) Photoelectric Sensors

(B) Fiber Optic Sensors

(C) LIDAR

(D) Door/Area Sensors

(E) Vision Sensors

(F) Proximity Sensors

(G) Pressure Sensors

(H) Rotary Encoders

(I) Connectors/ Connector Cables/ Sensor Distribution Boxes/ Sockets

BJ Series

Control Output Diagram

• NPN open collector output

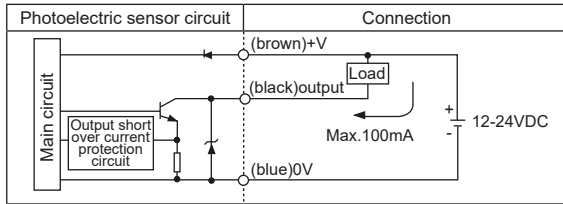

• PNP open collector output

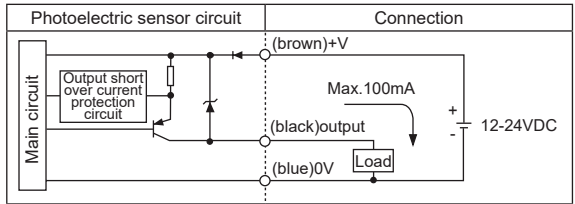

※If short-circuit the control output terminal or supply current over the rated specification, normal control signal is not output due to the output short over current protection circuit.

Operation Mode

Operation mode	Light ON	Dark ON
Receiver operation	Received light Interrupted light	Received light Interrupted light
Operation indicator (red LED)	ON OFF	ON OFF
Transistor output	ON OFF	ON OFF

Dimensions

(unit: mm)

• Through-beam type

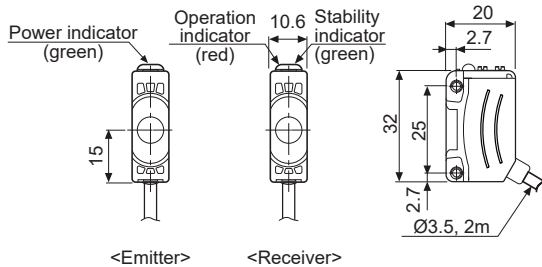

• Through-beam type (connector type)

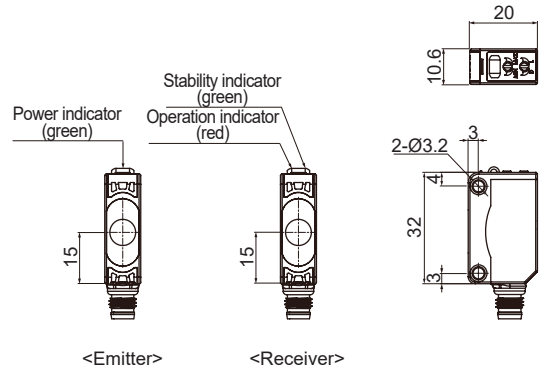

• Retroreflective type

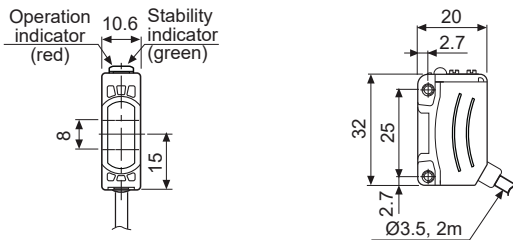

• Retroreflective type (connector type)

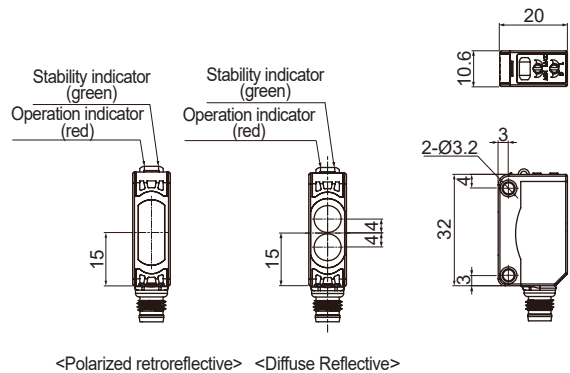

Long Sensing Distance/BGS Reflective/Micro Spot Type

• Reflector(MS-2A)

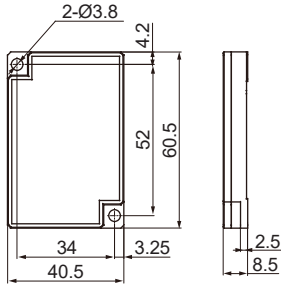

• Bracket A

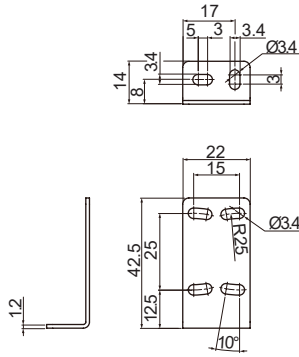

• Bracket B

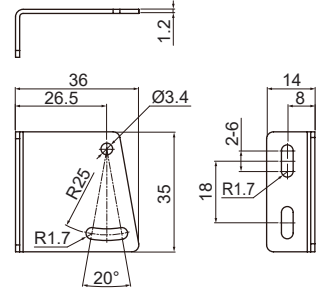

※Cable type provides the bracket A and connector type provides the bracket B.
The other bracket is also available as sold separately.

• Reflective tape (sold separately)

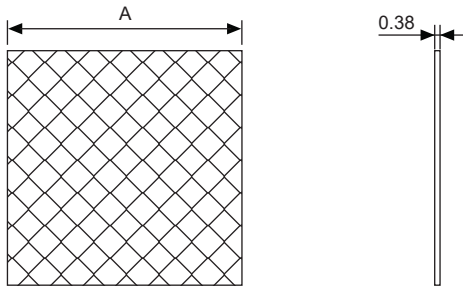

(unit: mm)

Model	A
MST-50-10	<input type="checkbox"/> 50
MST-100-5	<input type="checkbox"/> 100
MST-200-2	<input type="checkbox"/> 200

■ Operation Timing Diagram

• Through-beam type

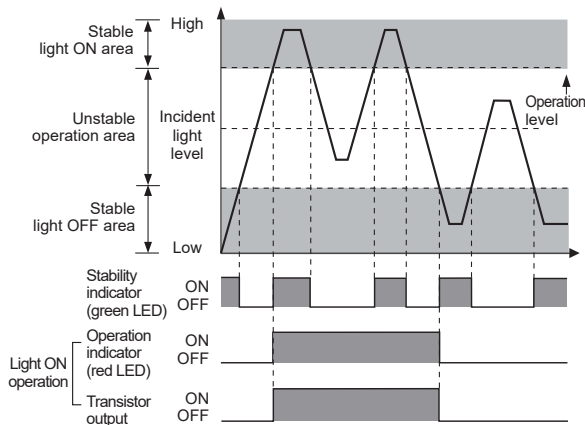

• Retroreflective/Diffuse/Narrow beam/BGS reflective type

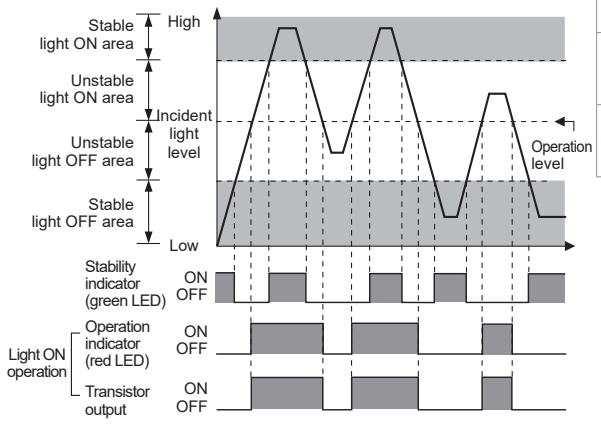

※The waveforms of "Operation indicator" and "Transistor output" are for Light ON operation.
They are opposite operation for Dark ON operation.

■ Mounting and Adjustment

◎ For mounting

When using the reflective type photoelectric sensors closely over three units, it may result in malfunction due to mutual interference.

When using the through-beam type photoelectric sensors closely over two units, it may result in malfunction due to mutual interference.

When installing the product, tighten the screw with a tightening torque of 0.5N·m.

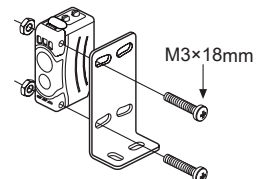

SENSORS

CONTROLLERS

MOTION DEVICES

SOFTWARE

(A) Photoelectric Sensors

(B) Fiber Optic Sensors

(C) LIDAR

(D) Door/Area Sensors

(E) Vision Sensors



(F) Proximity Sensors

(G) Pressure Sensors

(H) Rotary Encoders

(I) Connectors/ Connector Cables/ Sensor Distribution Boxes/ Sockets

◎ Switching of operation mode

Light ON operation		Turn the operation mode switch to the end of right (L direction), it is set as Light ON.
Dark ON operation		Turn the operation mode switch to the end of left (D direction), it is set as Dark ON.

※For through-beam type, the operation mode switch is built-in the receiver.

◎ Optical axis adjustment

● Through-beam type

- Place the emitter and the receiver facing each other and supply the power.
- After adjusting the position of the emitter and the receiver and checking their stable indicating range, mount them in the middle of the range.

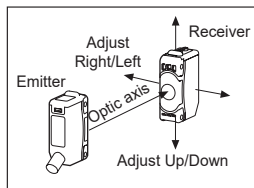

- After mounting this unit, check the operation of the sensor and lighting of the stability indicator in both status. (none or sensing target status)

※When the sensing target is translucent or small (under sensing target of '■ Specifications'), it may not be detected by the sensor because the light can penetrate it.

● Retroreflective type

- Place the sensor and the reflector (or reflective tape) facing each other and supply the power.
- After adjusting the position of the sensor and reflector (or reflective tape) and checking their stable indicating range, mount them in the middle of the range. (none or sensing target status)
- After mounting this unit, check the operation of the sensor and in both status. (none or sensing target status)

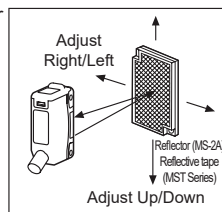

※Please use reflective tape (MST Series) for where a reflector is not installed.

● Diffuse/Narrow beam/BGS reflective type

After placing a sensing target, adjust the sensor to up or down, right or left. Then, fix the sensor in the center of position where the stability is operating.

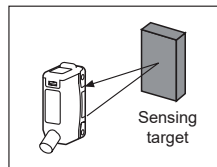

● Object (copper wire) detection <Micro spot type>

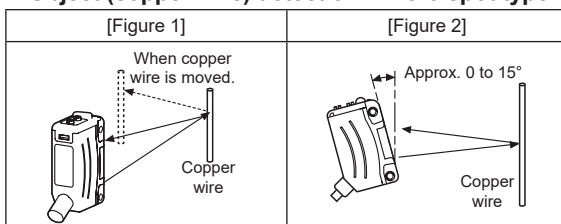

※Mount the sensor slanted at an angle ranged 0 to 15° shown above as [Figure 2] for stable detection to detect as shown in [Figure 1].

◎ Sensitivity adjustment

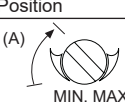
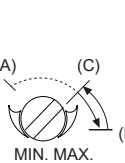
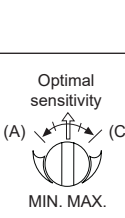
Order	Position	Description
1		Turn the sensitivity adjuster to the right of min. and check position (A) where the operation indicator is turned ON in "Light ON status".
2		Turn the sensitivity adjuster more to the right of position (A), check position (B) where the operation indicator is turned ON. And turn the sensitivity adjuster to the left, check position (C) where the operation indicator is turned OFF in "Light OFF status". ※If the operation indicator is not turned ON although the sensitivity adjuster is turned to the max. position, the max. position is (C).
3		Set the sensitivity adjuster at the center of (A) and (C). To set the optimum sensitivity, check the operation and lighting of stability indicator with sensing target or without it. If the stability indicator is not turned ON, please check the sensing method again because sensitivity is unstable.

※No sensitivity adjustment function available for BJG30-DDT models.

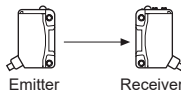
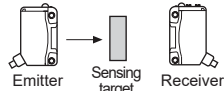
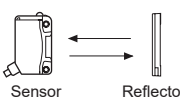
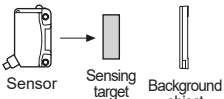
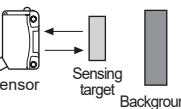
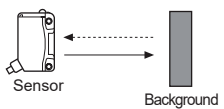
	Light ON status	Light OFF status
Through-beam type		
Retro-reflective type		
Diffuse/Narrow beam/BGS reflective		

※Set the sensitivity to operate in stable light ON area and the reliability for the environment (temperature, voltage, dust etc) is increased. In unstable light ON area, be sure to check the variation of environment.

※Do not apply excessive force on the sensitivity adjuster or operation mode switch, they may be broken.

※Please use reflective tape (MST Series) for where a reflector is not installed.

■ Reflectivity by Reflective Tape Model

MST-50-10(50×50mm)	40%
MST-100-5(100×100mm)	60%
MST-200-2(200×200mm)	100%

※This reflectivity is based on the reflector (MS-2A).

※Reflectivity may vary depending on usage environment and installation conditions.

The sensing distance and minimum sensing target size increase as the size of the tape increases.

Please check the reflectivity before using reflective tapes.

※For using reflective tape, installation distance should be min. 20mm.