

Frequency Inverters  
SJ Series Type P1

**HITACHI**  
Inspire the Next



EtherCAT

PROFIBUS

PROFINET

Ethernet

Automation Solutions by Hitachi



# SJ Series, Type P1 – High Performance Inverter

Hitachi maintains research and development departments throughout the business. These are continually working on the further improvement of products and technologies and synergy effects are specifically used in product policy. As a result, many components for Hitachi products are manufactured within the company itself.

Hitachi offers a broad range of high performance inverters for many industrial applications. The inverters' modular design and high versatility ensure optimal, cost-efficient technical solutions which can be individually adapted to the respective application. The industrial inverters can be configured easily, and are designed to deliver unprecedented performance, reliability and flexibility.

The new SJ Series, Type P1 is at the cutting edge of technology for premium inverters. Highly flexible, it is suitable for a wide variety of demanding applications. SJ-P1 has premium drive characteristics to achieve instantaneous force and efficient operation.





**Ease of Use** \_\_\_\_\_ Page 04

**Flexible & User-friendly** \_\_\_\_\_ Page 06

**Safety & Safe Operation** \_\_\_\_\_ Page 08

**SJ-P1 Smooth Operation and Precision** \_\_\_\_\_ Page 10

**Various Functions** \_\_\_\_\_ Page 12

**Eco-friendly** \_\_\_\_\_ Page 13

**Specifications** \_\_\_\_\_ Page 14





# Ease of Use

## ProDriveNext Software

Easy to use programming software allows user-friendly and intuitive operation.

- Online monitoring of all parameters and I/O terminal status
- Parameter conversion between different series
- Faster parameter download/upload with USB communication
- Windows XP, 7, 8, 10 compatible

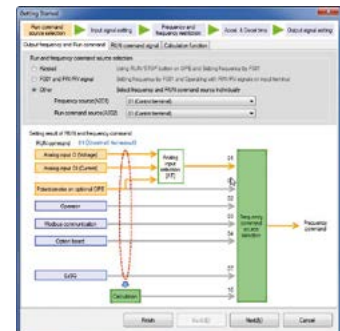

## Easy operation

- LED control
- RS422 port
- Micro USB port

## VOP colour LCD operator

- 12 languages available
- Colour TFT display
- Real time clock built-in
- Parameter and EzSQ programming data copy function

## Password function

Helps to ensure that parameters remain secured and safeguarded.

User-friendly display



USB port



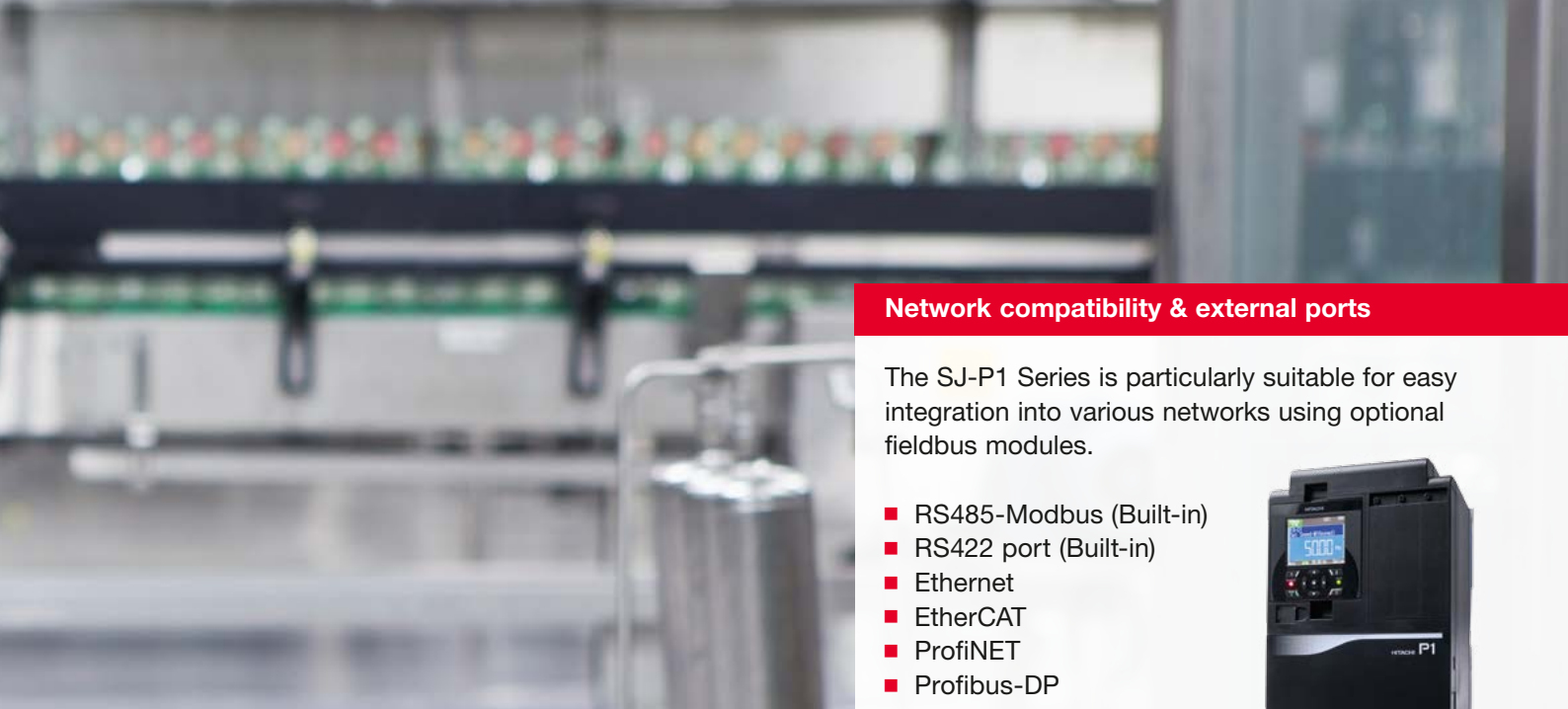

**Network compatibility & external ports**

The SJ-P1 Series is particularly suitable for easy integration into various networks using optional fieldbus modules.

- RS485-Modbus (Built-in)
- RS422 port (Built-in)
- Ethernet
- EtherCAT
- ProfiNET
- Profibus-DP

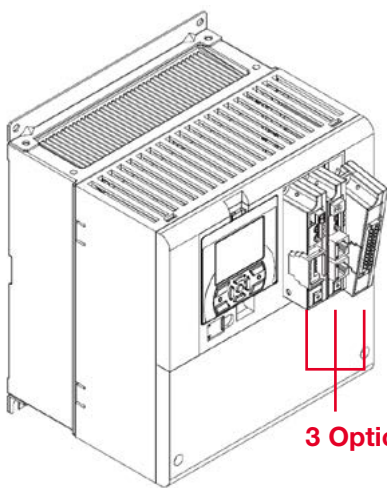

**3 Option slots**

**Option slots**

Hitachi original cassette option for flexible use.

- Up to 3 options can be used simultaneously
- Easy access from the inverter front
- Various fieldbus and I/O options available

**Option modules**

- Ethernet
- EtherCAT
- Profibus-DP
- ProfiNET
- Feedback
- Safety
- Analog input and output
- Relay output



**EzCOM Inverter-to-Inverter communication**

SJ-P1 also gives the option to communicate by using Inverter-to-Inverter connections without a PLC or PC.

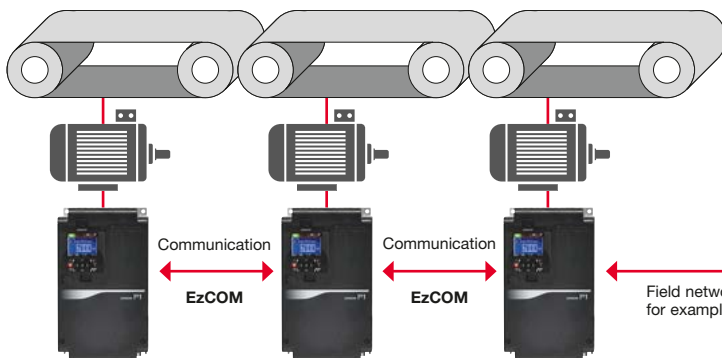

For example Hitachi's PLC

Field network communication, for example EtherCAT



# Flexible & User-friendly

## Easy wiring



Screwless terminal block (control terminal block).

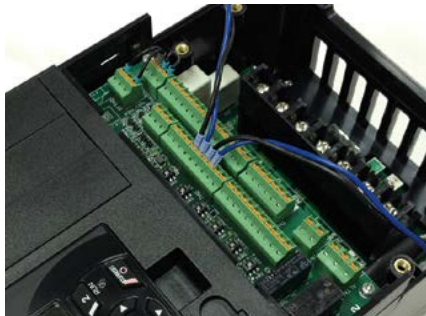

Modbus communication as standard – two communication terminals are provided. Therefore daisy chain wiring is easy to realize.

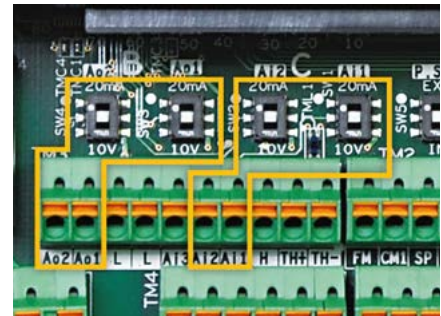

0–10V in/out and 4~20 mA in/out are easily switched by DIP switch.

- 2 analog inputs (3 inputs in total)
- 2 analog outputs

## Heat sink extraction

It is easy to place the cooling fans to the outside of the cabinet since the L-shaped brackets are separate parts.

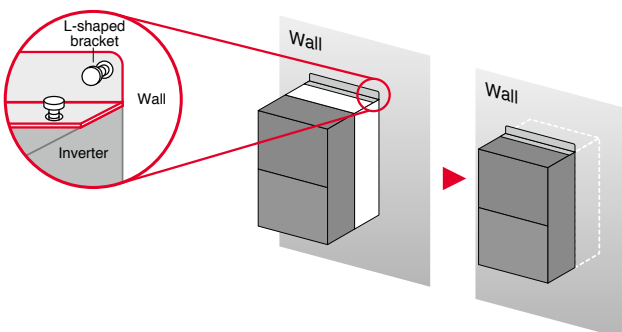

## Fulfilling lifetime prediction functions

- Electrolytic capacitor of power circuit
- Cooling fan



### Improved efficiency with 24VDC supply

In addition to normal power supply (R0, T0), external 24VDC control power can also be applied as standard. Parameter setting is also available if the main power is turned off meaning operational efficiency is increased and standby power is reduced. It will also contribute to energy savings. Connecting to the PLC and settings via PC configuration software are also available.

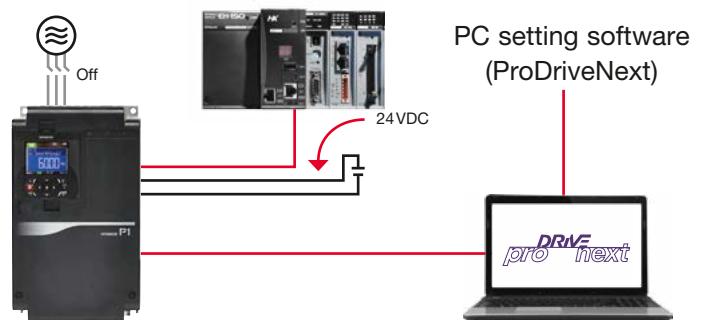

### Quick diagnose of failure occurrence

P1 can also store internal data to the internal memory on a continuous basis. It can also upload data to the PC when an error occurs – making rapid diagnosis possible.

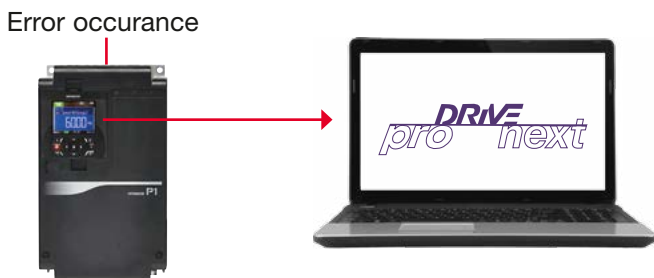

### Easy to customize with configuration software

- **PC software**  
The configuration software 'ProDriveNext' easily enables the user to set up, monitor and diagnose the device.
- **Customization of functions can be easily achieved**  
The existing functions can be modified by using a 'BASIC'-like programming language.

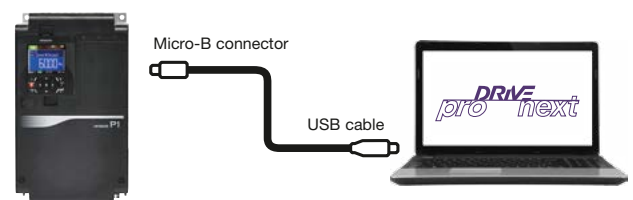

# Safety & Safe Operation

## Certified "functional safety" international standard

- Certified functional safety
- Third party certified electrical safety
- Also in compliance EN61508, IEC/EN/UL61800-5-2 SIL3
- STO as functional safety standard
- IEC/EN60204-1 Stop Cat. 0
- EN/ISO13849-1 Cat. 3, PLe
- IEC61508, IEC/EN/UL61800-5-2, IEC/EN62061 SIL3 STO
- SS1, SLS and others are available with slot-in option card

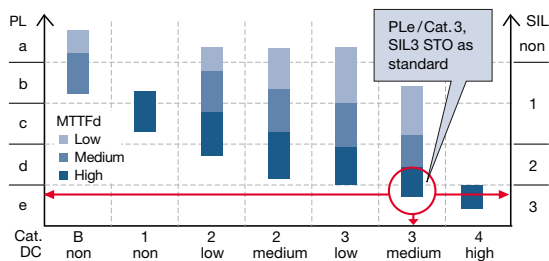

## Standard (without option card)

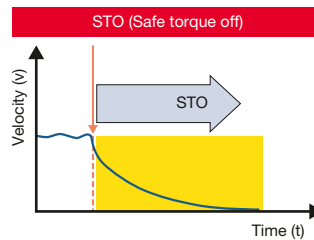

## Optional (needs slot-in card)

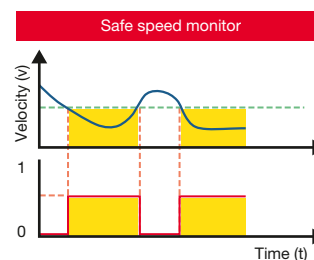
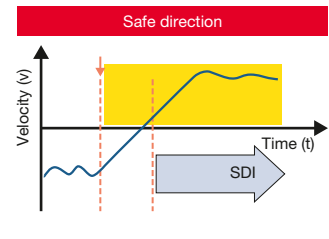
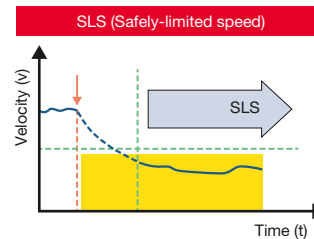
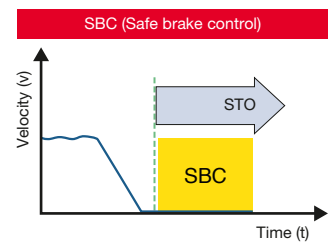
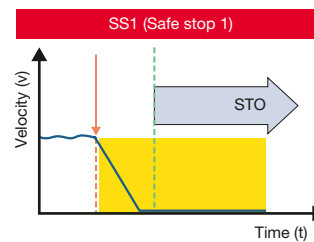





**Trip avoidance functions**

Minimum time deceleration function, over-current suppression and DC bus AVR functions are included as standard.

These functions increase the robustness of the product and help to avoid unnecessary tripping. Improved torque limiting/ current limiting functionality enables load restrictions to be applied in order to protect machinery and equipment.

Minimum time Deceleration Function

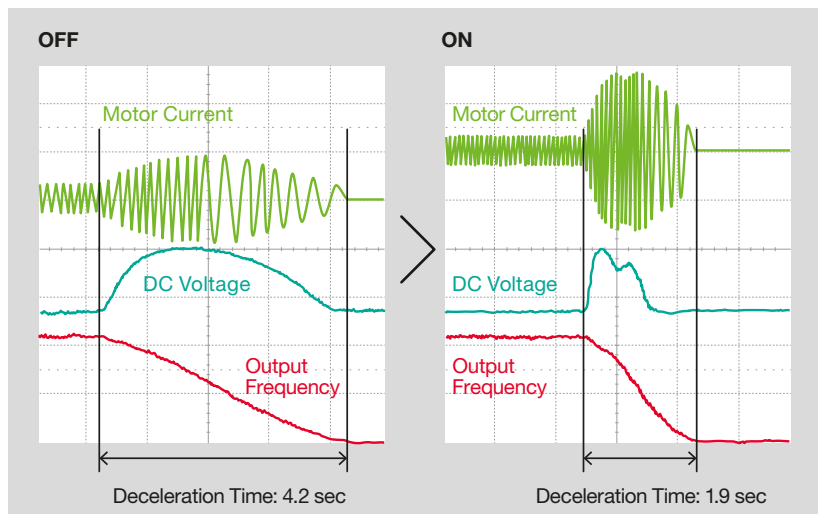

Over-current Suppression Function\*

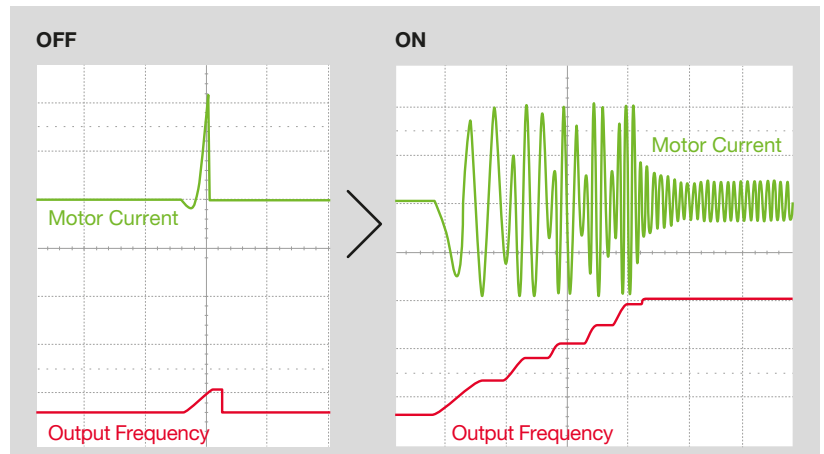

\*Turn off this function for lifting equipment.

# SJ-P1 Smooth Operation and Precision

## “Smooth operation” can be easily achieved

High starting torque from the low speed area supports the smooth drive of heavy load.

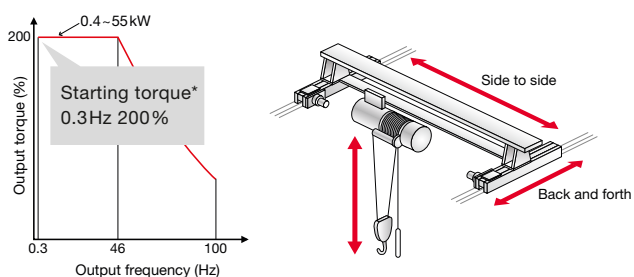

(\*Sensorless vector control with ND rating)

Decreasing overshoot and undershoot contributes to smooth and stabilized operation with less shock.

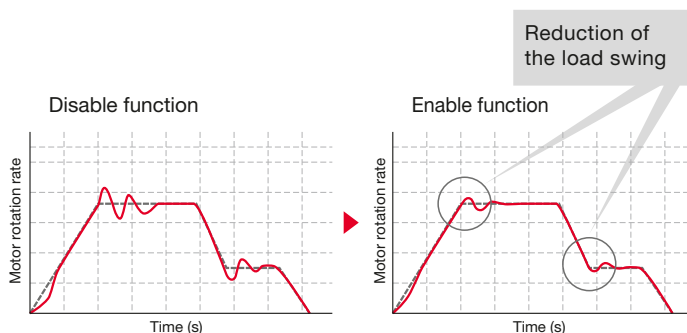

## Steady operation for crane, lift, transport etc.

Trip can be prevented by smooth driving to support steady operation of crane and conveyer for better productivity.



## “High speed rotation” for precision

590Hz operation is available for precise metal processing. PM motor is also available up to 400Hz.

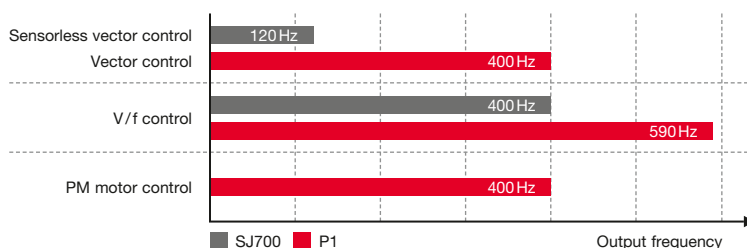



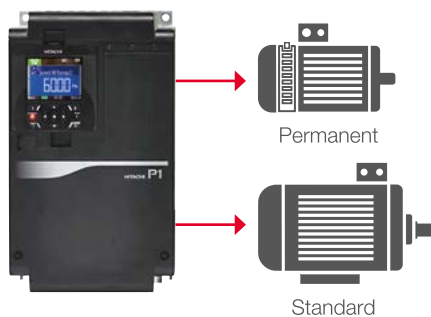

**Induction motor & permanent magnet motor can be controlled with one inverter series**

The SJ-P1 inverter can be used to drive both induction motors (IM) and permanent magnetic motors (PM). PM motors are energy efficient and make effective use of available space. Thanks to the over-current trip level setting, demagnetization of PM motors can be suppressed.



**Multi-rating to support space and cost savings**

Triple-rating for IM motor for various applications is available. Also dual-rate for PM motor control can be selected. Multi-rating helps to save space and costs.

Rating	VLD (Very Light Load)	LD (Light Load)	ND (Normal Load)
Induction motor			
PM motor			
Applications	Fan-pump		
		Metal tooling-conveyer	
			Crane-mixer
Overload current rating	110% 60sec, 120% 3sec	120% 60sec, 150% 3sec	150% 60sec, 200% 3sec
Example 400 V / 18.5 kW Max rated output current	47.0A 	43.0A 	39.0A 



# Various Functions

## Intuitive and easy-to-use TFT LCD operator

### Quick View:

Get an overview



Multi-monitor (3 lines)

### Verify View:

Monitor all settings



Reference screen

### Clear View:

Easy to see



Large monitor screen

### Error View:

Quick trouble shoot



Trip history screen

## Built-in BRD circuit

Built-in braking resistor control circuit is available as standard in all models up to 37 KW (resistor optional).

## EzCOM (peer-to-peer communication)

SJ-P1 supports peer-to-peer communication between multiple inverters using the built-in RS485 port. In this configuration one administrator inverter is required in the network whilst the other inverters act as master or slave.



# Eco-friendly

## **RoHS compliant**

The SJ Series, Type P1 meets EU RoHS requirements.

---

## **Endurance in severe conditions**

Vanish coating of the internal PC board ensures an improved endurance to certain severe conditions (logic PCB and I/F PCB are excluded).

---

## **Long life components**

The cooling fans and built-in capacitors have an estimated design lifetime of 10 years\*. By using the ON/OFF control function the lifetime can be extended.

\*10 years is a design lifetime based on calculation, not guaranteed



## General specifications

Item		General specifications	
PWM system		Sine-wave PWM system	
Output frequency range		0.00 to 590.00 Hz	
Frequency accuracy		For the highest frequency, Digital: $\pm 0.01\%$ , Analogue: $\pm 0.2\%$ ( $25 \pm 10^\circ\text{C}$ )	
Frequency resolution		Digital: 0.01 Hz, Analogue: Max. frequency / 4000 (Ai1 terminal / Ai2 terminal: 12bit / 0 to +10V or 0 to +20 mA, Ai3 terminal 12bit / -10 to +10V)	
Volt./Freq. characteristic	IM	V/F control (constant torque/reduced torque/free), Automatic boost control, V/F control with encoder (constant torque/reduced torque/free), Automatic boost control with encoder, Cascade type sensorless vector control, 0 Hz sensorless vector control	
	SM/PM	Method of synchronous startup for smart sensorless vector control	
Acceleration / Deceleration time		0.00 to 3600.00 seconds (Linear, S-curve, U-curve, Inverted-U-curve, EL-S-curve)	
DC braking		Variable operating frequency, delay time, braking force, time	
Input signal	Digital	11 terminals, NO/NC switchable, Sink/Source changeable by switch (A or B terminal accept a pulse train)	
	Analog	4 terminals Ai1 / Ai2 terminal (0 to 10VDC or 0 to 20 mA, Input impedance: 10 k $\Omega$ ), Ai3 terminal (-10 to +10VDC, Input impedance: 10 k $\Omega$ ) Thermistor input terminal (PTC/NTC resistor allowed)	
	Pulse train (These can be used as digital input terminal too)	2 terminals (Maximum 27VDC, 5.6 mA, 32 kHz)	
Output signal	Digital	5 transistor output terminals	
	Analog	2 terminals (0 to 10VDC or 0 to 20 mA)	
	Pulse train	1 terminal (0 to 10VDC, Maximum 1.2 mA, 3.60 kHz)	
	Relay	1 1a contact relay, 1 1c contact relay	
Network	Standard	RS485 (Modbus RTU), USB micro B port, RJ45 port	
	Option	Ethernet, EtherCAT, Profibus-DP, ProfiNET	
Other functions		V/F free setting (7 points), Upper and lower frequency limit, Frequency jump, Curve acceleration and deceleration, Manual torque boost, Energy-saving operation, Analogue output adjustment, Minimum speed, Carrier frequency adjustment, Motor electronic thermal function (free is possible), Inverter thermal function, External start-end (speed and rate), Frequency input selection, Trip retry, Restart stop, Various signal output, Initialization setting, PID control, Auto-decel at shut-off, Brake control function, Commercial switching function, Auto-tuning (on/offline), etc.	
Functional safety		STO: SIL3, Cat. 3 / PL <sub>e</sub>	
Protection functions		Overcurrent error, Overload error, Brake resistor overload, Over voltage error, Memory error, Undervoltage error, Current detector error, CPU error, External trip error, USP error, Ground error, Supply overvoltage error, Phase output error, Thermistor error, Brake error, Low-speed range overload error, Inverter overload, RS485 communication error, RTC error, etc.	
Operating environment	Ambient temperature	VLD	-10 to 40 °C
		LD	-10 to 45 °C
		ND	-10 to 50 °C
	Storage temperature		-20 to 65 °C
	Humidity		20 to 90% RH (No condensation allowed)
	Vibration	P1-00041-H (P1-004H) to P1-00620-H (P1-220H)	5.9 m/s <sup>2</sup> (0.6 G), 10 to 55 Hz
P1-00770-H (P1-300H) to P1-03160-H (P1-1320H)		2.94 m/s <sup>2</sup> (0.3 G), 10 to 55 Hz	
Installation place		A maximum altitude of 1000 m, without gases or dust	
Certification		UL, c-UL, CE marking, RCM (planned: KC, EAC, NK)	
Options		Option cassette: Input/Output option (Analog input/output option, Relay output option), Communication (Ethernet, EtherCAT, Profibus-DP, ProfiNET), Feedback (Line drive output 00041, Push-pull output, Resolver output), Temperature detector (Optional temperature measuring sensor)  Others: Braking resistor, AC/DC reactor, Noise filter, Operator cable, Harmonics suppression unit, Noise filter, LCR filter, Analog panel, Regenerative braking unit, PC software "ProDriveNext", Relay expansion terminal board	

## Conformity to global standards

CE, UL, c-UL, c-Tick approvals.

## Sink/source logic is standard

Logic input and output terminals can be configured for sink or source logic.

## Wide input power voltage range

Input voltage range from 380V to 500V as standard.



## Standard specifications

Model name P1-****-H		00041	00054	00083	00126	00175	00250	00310	00400	00470	
Enclosure		IP20									
Applicable motor capacity (4 poles) (kW)	VLD	1.5	2.2	3.7	5.5	7.5	11	15	18.5	22	
	LD	1.5	2.2	3.7	5.5	7.5	11	15	18.5	22	
	ND	0.75	1.5	2.2	3.7	5.5	7.5	11	15	18.5	
Rated capacity (kVA)	400V	VLD	2.8	3.7	5.8	8.7	12.1	17.3	21.5	27.7	32.6
		LD	2.1	3.3	4.6	7.7	11.1	15.2	20.1	25.6	29.8
		ND	1.7	2.8	3.8	6.4	10.3	13.2	17.3	22.2	27.0
	500V	VLD	3.6	4.7	7.2	10.9	15.2	21.7	26.8	34.6	40.7
		LD	2.7	4.2	5.8	9.6	13.9	19.1	25.1	32.0	37.2
		ND	2.2	3.5	4.8	8.0	12.8	16.5	21.7	27.7	33.8
Rated input AC voltage		Control power: Single-phase supply 380 to 500V (+10%, -15%), 50 Hz/60 Hz (±5%) Main power: 3-phase (3 wire) 380 to 500V (+10%, -15%), 50 Hz/60 Hz (±5%)									
Rated output current (A)	VLD	4.1	5.4	8.3	12.6	17.5	25.0	31.0	40.0	47.0	
	LD	3.1	4.8	6.7	11.1	16.0	22.0	29.0	37.0	43.0	
	ND	2.5	4.0	5.5	9.2	14.8	19.0	25.0	32.0	39.0	
Overload current rating	VLD	110 % 60 sec / 120 % 3 sec									
	LD	120 % 60 sec / 150 % 3 sec									
	ND	150 % 60 sec / 200 % 3 sec									
Rated output voltage		3-phase (3 wire): 380 to 500V (proportional to input voltage)									
Starting torque (ND)		200 % / 0.3 Hz									
Regenerative braking		Internal BRD circuit (external discharge resistor)									
Minimum resistance value (Ω)		100	100	100	70	70	35	35	24	24	
H (height) (mm)		255	255	255	255	260	260	260	390	390	
W (width) (mm)		150	150	150	150	210	210	210	245	245	
D (depth) (mm)		140	140	140	140	170	170	170	190	190	
Weight (kg)		4	4	4	4	7	7	7	16	16	

Model name P1-****-H		00620	00770	00930	01160	01470	01760	02130	02520	03160	
Enclosure		IP20					IP00				
Applicable motor capacity (4 poles) (kW)	VLD	30	37	45	55	75	90	110	132	160	
	LD	30	37	45	55	75	90	110	132	160	
	ND	22	30	37	45	55	75	90	110	132	
Rated capacity (kVA)	400V	VLD	43.0	53.3	64.4	80.4	101.8	121.9	147.6	174.6	218.9
		LD	39.5	48.5	58.9	72.7	93.5	110.9	135.1	159.3	200.9
		ND	33.3	42.3	52.0	63.0	77.6	103.9	124.7	150.3	180.1
	500V	VLD	53.7	66.7	80.5	100.5	127.3	152.4	184.5	218.2	273.7
		LD	49.4	60.6	73.6	90.9	116.9	138.6	168.9	199.2	251.1
		ND	41.6	52.8	65.0	78.8	97.0	129.9	155.9	187.9	225.2
Rated input AC voltage		Control power: Single-phase supply 380 to 500V (+10%, -15%), 50 Hz/60 Hz (±5%) Main power: 3-phase (3 wire) 380 to 500V (+10%, -15%), 50 Hz/60 Hz (±5%)									
Rated output current (A)	VLD	62.0	77.0	93.0	116	147	176	213	252	316	
	LD	57.0	70.0	85.0	105	135	160	195	230	290	
	ND	48.0	61.0	75.0	91.0	112	150	180	217	260	
Overload current rating	VLD	110 % 60 sec / 120 % 3 sec									
	LD	120 % 60 sec / 150 % 3 sec									
	ND	150 % 60 sec / 200 % 3 sec									
Rated output voltage		3-phase (3 wire): 380 to 500V (proportional to input voltage)									
Starting torque		200 % / 0.3 Hz					180 % / 0.3 Hz				
Regenerative braking		Internal BRD circuit			opt. internal			Ext. regen. braking unit			
Minimum resistance value (Ω)		20	15	15	10	10	-	-	-	-	
H (height) (mm)		390	540	550	550	550	700	700	740	740	
W (width) (mm)		245	300	390	390	390	390	390	480	480	
D (depth) (mm)		190	195	250	250	250	270	270	270	270	
Weight (kg)		16	22	30	30	30	55	55	70	70	

# HITACHI

## Inspire the Next

Hitachi Europe GmbH, Am Seestern 18, D-40547 Düsseldorf  
Phone: +49(0)211-5283-0, Fax: +49(0)211-5283-649  
[www.hitachi-industrial.eu](http://www.hitachi-industrial.eu), [info@hitachi-ds.com](mailto:info@hitachi-ds.com)  
© Hitachi Industrial Equipment Systems Co., Ltd., Japan

All company and product names in this brochure are  
the property of the respective companies.