



Read this “Basic Guide”, and keep it handy for future reference.

## Basic Guide

HITACHI SJ Series Inverter

# P1



Introduction

Contents

Chapter 1: Safety Instructions

Chapter 2: Installation and Wiring

Chapter 3: Operation Setting and Examples of I/O Adjustment

Chapter 4: Settings

Chapter 5: FAQ/Troubleshooting

Chapter 6: Maintenance and Inspection

Chapter 7: Specifications

Index

List of contact information

If you have any inquiry or problem,  
Refer to Chapter 5 Troubleshooting  
or  
Contact to the Technical Inquiry Service  
for Inverter.

When making a contact, inform  
the reference number on below.

**NT2511BX-1**

---

## Introduction

---

Thank you for purchasing Hitachi SJ Series P1 Inverter. This is a user guide for basic handling and maintenance of Hitachi SJ Series P1 Inverter.

For the purpose of reduction of paper usage and provision of the latest information, we enclose the Basic Guide only while providing the User's Guide for more detailed description through electronic means instead of CD or a printed document.

### ■ About the Basic Guide (this document)

The Basic Guide provides the minimum information necessary for handling the product. Please make sure to read this document as well as the User's Guide with more detailed information.

### ■ About the User's Guide

The User's Guide provides detailed information necessary for handling the product. Please make sure to read the User's Guide for proper use.

If future updates make any difference from the Basic Guide, the description in the User's Guide will have higher priority. You should use the inverter by observing specifications described in User's Guide. You should also prevent risks by performing proper inspection and maintenance.

Please refer to the following link for download:

Hitachi Industrial Equipment Systems' Website  
<http://www.hitachi-ies.co.jp/>

Please follow as below on the Website.

Product Information -> Inverter -> Download of technical data

### ■ Handling an optional products

If you use the inverter with optional products, also you should read the instruction enclosed in those products.

---

## Cautions

---

### ■ Proper use of the inverter

Please read the Basic Guide, User's Guide and optional products instruction before handling. Read carefully the Basic Guide, User's Guide or optional product instruction before handling or performing maintenance of the product.

Before attempting installation, operation, maintenance, and inspection work, you should understand the knowledge of equipment, information of safety, precaution and how to use and service the inverter.

### ■ Cautions

No part of this document may be reproduced or reformed in any form without the publisher's permission.

The contents of the document are subject to change without prior notice.

If you lose the Basic Guide and need another one in printed form, you will be charged for resupply, so please keep it carefully.

You "CANNOT DO" what is not described in Basic Guide or User's Guide. We are not responsible for any impact from operations regardless of unexpected failure or accident due to the operation or handling of the product in a manner not specified in Basic Guide or User's Guide. We apologize in advance for any inconvenience this may cause.

If you find any unclear or incorrect description, missing description, or misplaced or missing pages, please takes time to inform Hitachi inverter technical service office.

Note that, the Basic Guide, User's Guide and the instruction for each optional product enclosed, should be delivered to the end user of the inverter. And also make sure to be accessible any other guides or instruction to the end user.

## Method of Inquiry and Product Warranty

### Method of Inquiry about Product

- For an inquiry about product damage or faults or a question about the product, notify your supplier or Hitachi inverter technical service office.

### Product Warranty

- The product SJ series P1 inverter will be warranted by Hitachi Industrial Equipment Systems Co., Ltd., afterward "Hitachi", during the warranty period from your date of purchase only under proper usage of product.
- Furthermore, the warranty expressed here is covered only for the product delivered from Hitachi, and will not be responsible for others damage or loss of products like a motor or any equipment or systems damage caused by improper usage of the product. Minimize the consequence on equipment or system by applying safety design which is able to notify a hazard alarm to the user in case of malfunction or damage of the delivered product. The selection and application of delivered product must be done with sufficient margin on performance, as well as other equipment or system with sufficient redundancy design. Also, the compatibility of the product with the customer's intended use is not warranted, hence the validation test should be done by the customer by their responsibility before put in operation.
- In case of delivery a defective product, or encountered a defects on quality during a manufacturing process, Hitachi will repair or exchange with free of charge, only when the product is in warranty period (afterward, we call "warranty service").
- The product will be warranted for one year from your date of purchase. However, depending on case, sending technical assistance for repairing will be charged to the customer. Also, Hitachi will not be responsible of any readjustment or testing on site.
- After warranty service, the exchanged or repaired part will be warranted for 6 month from date of warranty service. Hitachi will be responsible for repair or exchange of defective part only for the exchanged or repaired part only during this warranty period.

- Inverter Model: It beginning with P1- in specification label.
- Manufacturer Number(MFG No.): It shows in specification label.
- Date of purchase: Customer's purchased period.
- Inquiry contents:
  - Inform us the defective point and its condition.
  - Inform us the suspicious content and its detail.

- In order to receive warranty service, you should present the recipe issued by product supplier or any other document that permit to check the purchase date. However, any defects, damage, malfunction or any other failure caused by one of the following facts will not be covered by warranty service.
  - (1) Cannot confirm the purchase date.
  - (2) The damage or fault resulted from improper usage or inadequate handling of the product and not conforming usage described into the user's guide or basic guide.
  - (3) Incorrect usage of product, inadequate setting of product and optional product, remodeling or inadequate repair and repair carried out by unqualified repair center.
  - (4) Deterioration and wear resulted from normal operation.
  - (5) Fault resulted from natural disaster, such as earthquake, fire disaster, lightning strike, pollution, salt pollution, or abnormal voltage or any others external factor.
  - (6) Shock, falling, or Vibration resulted during transportation or displacement after purchase.
  - (7) Damage or fault resulted from remodeling firmware by unqualified personal not belonging to Hitachi.
  - (8) Damage or fault resulted from customer's made programing function (EzSQ).
  - (9) For overseas use.
- By warranty service, might lose the data stored inside the product, as well as, customers made (EzSQ) program. Make sure to back up by own responsibility. However, in case of malfunction resulting from the circuit board of the storage devices, the backup wil not be possible. It is recommended to keep a backup during the testing phase by using VOP or PC software ProDriveNext.

### Liability Limitation

- Neither Hitachi-IES, Affiliated company nor related dealer are liable to the written and unwritten public requirement including the common sense of the product or requirement in specific application
- Even more, Hitachi, affiliated company or related dealer are not responsible of any incidental damage, special damage, direct loss, or indirect loss (even predictable or not) resulted on customer because of product defect.

### Warranty Service

- The customer is able to receive a warranty service from product supplier or service station, if the product does not meet the function described on basic guide or user's guide. Moreover, in case of any mismatch occurred between user's guide and basic guide, user's guide content will take a priority.
- Contact to your supplier or local Hitachi distributor or service station for fare-paying services.

### Change on Product Specification

- We are sorry because any information described in Brochure, Basic Guide, User's Guide or Technical Document would be modified without notice.

### Precaution for Product Application

- The product should apply following the condition of use, handling method and precautions described in User's Guide.
- The installed product should be confirmed previously by own that the product installation has done as intended in the customer system.
- When using Hitachi inverter consider on below
  - (1) Select inverter with sufficient capacity for rate current and performance.
  - (2) Safety design, for example, redundant system design.
  - (3) Equipment design where minimize hazard in case of inverter failure.
  - (4) For safety precautions, make a system configuration that alarms the hazard to user.
  - (5) Periodic maintenance of Hitachi inverter and customer's equipment.
- Hitachi inverter is designed and manufactured intentionally to be applied for general industrial equipment application. It is not intended to be used for the applications listed below therefore. In case inverter is used for these applications, it is out of warranty unless there is a special written agreement. Otherwise, the product will not be warranted.
  - (1) Special application such as aircraft, spacecraft, nuclear, electric power, passenger transportation, medical, submarine repeater, etc.
  - (2) For application such as elevator, amusement equipment, medical equipment which might have a big effect on human life and property.
- Even for above application, in case there is an agreement for the limitation of the purpose and quality, please contact to our sales office. Further study will be carried out to check whether inverter is applicable for that specific application or not.
- For applications that involve human life, or have risk of important loss, make sure to avoid a critical accident by installing a fail-safe device, protecting device, detecting device, alarm device, or spare device, etc.
- This inverter is only for three phase induction motor [IM] or three phase synchronous motor [SM(SMM)].
- For any other application make inquiries.

### Supplement

- Refer to "Chapter 7 Specification" for short lifespan component.
- For optional product refer attached instruction.
- This warranty term will not restrict a legal right of customer who has purchased the product.
- Contact to the local supplier for warranty of purchased product sales in oversea.

### Contact Information

#### Hitachi America, Ltd. (Charlotte Office)

Industrial Components and Equipment Division  
6901 Northpark Blvd., Suite A, Charlotte, NC 28216,  
U.S.A  
TEL : +1(704) 494-3008  
FAX : +1(704) 599-4108

#### Hitachi Europe GmbH

Industrial Components & Equipment Group  
Am Seestern 18 (Euro Center),  
D-40547 Dusseldorf,  
Germany  
TEL : +49-211-5283-0  
FAX : +49-211-5283-649

#### Hitachi Asia Ltd.

Industrial Components & Equipment Division  
No.30 Pioneer Crescent, #10-15 West Park Bizcentral,  
Singapore 628560,  
Singapore  
TEL : +65-6305-7400  
FAX : +65-6305-7401

#### Hitachi Australia Ltd.

Level 3, 82 Waterloo Road  
North Ryde, N.S.W.2113  
Australia  
TEL : +61-2-9888-4100  
FAX : +61-2-9888-4188

#### Hitachi Industrial Equipment Systems Co., Ltd.

AKS Building, 3, Kanda  
Nereibeicho, Chiyoda-ku,  
Tokyo, 101-0022  
Japan  
TEL : +81-3-4345-6910  
FAX : +81-3-4345-6067

- Quick start ..... 0-1
- Introduction/instructions ..... 0-2
- Method of Inquiry and Product Warranty ..... 0-3
- Contents ..... 0-4

**Chapter 1 Safety Instructions**

- Types of Warnings ..... 1-1
- Description of Safety Symbols ..... 1-1
- Precautions for Installation ..... 1-2
- Precautions for Wiring ..... 1-2
- Precautions to Run and Test Running ..... 1-3
- Precautions for Maintenance/Inspection ..... 1-4
- Precautions for Disposal ..... 1-4
- Other Cautions ..... 1-4
- Compliance to European Directive (CE) ..... 1-5
- Compliance to UL standards ..... 1-7

**Chapter 2 Installation and Wiring**

- Check the Inverter ..... 2-1
- Install the Inverter ..... 2-2
- Dimensions Drawing ..... 2-4
- Inverter Wiring ..... 2-6
- Wiring of the main circuit ..... 2-7
- Recommended wire gauges, accessories etc ..... 2-8
- Applicable Circuit Breaker ..... 2-10
- Chopper Breaking Resistor ..... 2-12
- Wiring ..... 2-13
- Wiring of the Control Circuit ..... 2-17
- Control Circuit Wiring Section ..... 2-19
- Residual Risk ..... 2-24

**Chapter 3 Operation Setting and Examples of IO Adjustment**

- Operation Setting and Examples of IO Adjustment 3-1

**Chapter 4 Settings**

- Keypad overview ..... 4-1
- Monitor naming ..... 4-10
- Parameters naming ..... 4-13

**Chapter 5 Troubleshooting**

- Troubleshooting ..... 5-1

**Chapter 6 Inspection and Maintenance**

- Cautions for Maintenance/Inspection ..... 6-1
- Daily and Periodic Inspections ..... 6-2
- Method of Checking the Inverter and Converter Circuits ..... 6-4
- DC-Bus Capacitor Life Curve ..... 6-5
- Output of Life Warning ..... 6-5
- Methods of Measuring the Input/Output Voltages, Current, and Power ..... 6-6

**Chapter 7 Specifications**

- Specifications Table ..... 7-1

- Appendix Index ..... index-1
- Quick start ..... Appendix-1

(Memo)



# Chapter 1

## Safety Instructions

### 1.1 Types of Warnings

In the Basic Manual, the severity levels of safety precautions and residual risks are classified as: "DANGER", "WARNING" and "CAUTION".

Display meanings





 <b>DANGER</b>
Indicates that incorrect handling may cause hazardous situations, which would most likely result in serious personal injury or death, and may result in major physical loss or damage.
 <b>WARNING</b>
Indicates that incorrect handling may cause hazardous situations, which may result in serious personal injury or death, and may result in major physical loss or damage.
 <b>CAUTION</b>
Indicates that incorrect handling may cause hazardous situations, which may result in moderate or slight personal injury or damage, and may result only physical loss or damage.

Even more, that "⚠CAUTION " level description may lead to a serious risk depend on the circumstances. Be sure to follow the instruction because whichever contains important safety description.

### 1.2 Description of Safety Symbols

It describes annotation of the symbols in context. Be sure to follow and pay attention of content.

Symbols meaning

	Indicates a danger, warning or caution notice for fire, electric shock and high temperature while handling the product. Details are indicated in or near△by pictures or words.
	The drawing on the left indicates "a non-specific and general danger or caution".
	The drawing on the left indicates "a possible damage due to electric shock".
	Indicates "what you must not do" to prohibit the described acts in the operation of the product.
	Indicates "what you must do" according to the instructions in the operation of the product.

### 1.3 Description of Safety Symbols

Read carefully following safety instruction for handling.

1.3.1 Caution

 **DANGER**

 **Caution**

- Incorrect handling may result in personal death or severe injury, or may result in damage to the inverter, motor or the whole system.
- Be sure to read this Basic Manual and appended documents thoroughly before installing, wiring, operating, maintaining, inspecting or using the inverter.

 **Practice**

 **Caution**

- Many of the drawings in the Basic Guide show the inverter with covers and/or parts blocking your view as removed to illustrate the details.
- Do not operate the inverter in the status shown in those drawings. If you have removed the covers and/or parts, be sure to reinstall them in their original positions before starting operation, and follow all instructions when operating the inverter.

 **Practice**

1.3.2 Precautions for installation

 **WARNING**

 **Fire**

- **You run the risk of fire!**
- Do not place flammable materials near to the installed inverter.

 **Prohibited**

- Prevent foreign matter (e.g., cut pieces of wire, sputtering welding materials, iron chips, wire, and dust) from penetrating into the inverter.

 **Practice**

- Install the inverter on a non-flammable surface, such as, metal surface.
- Install the inverter in a well-ventilated indoor site not exposed to direct sunlight. Avoid places where the inverter is exposed to high temperature, high humidity, condensation, dust, explosive gases, corrosive gases, flammable gases, grinding fluid mist, or salt water.

 **Fall Injury**

- **You run the risk of injury due to the inverter falling**
- Do not hold its cover parts when carrying the inverter.

 **Prohibited**

- Install the inverter on a structure able to bear the weight specified in this Basic Guide.

 **Practice**

- Install the inverter on a vertical wall that is free of vibrations.

 **Injury**

- **You run the risk of injury!**
- Do not install and operate the inverter if it is damaged or its parts are missing.

 **Prohibited**

 **Failure**

- **You run the risk of failure of the inverter!**
- The inverter is precision equipment. Do not allow it to fall or be subject to high impacts.
- Also do not step on it, or place a heavy load on it.

 **Prohibited**

1.3.3 Precautions for Wiring

 **DANGER**

 **Electric shock Fire**

- **You run the risk of electric shock or fire!**
- Be sure to ground the inverter.
- Commit wiring work to a qualified electrician.
- Before wiring, make sure that the power supply is off.

 **Practice**

 **Electric shock Injury**

- **You run the risk of electric shock and injury!**
- Perform wiring only after installing the inverter.

 **Practice**

 **Failure**

- **You run the risk of failure of the inverter!**
- Do not pull the wire after wiring.

 **Prohibited**

 **Short circuit Ground**

- **You run the risk of short circuit and ground fault!**
- Do not remove rubber bushings from the wiring section. Otherwise, the edges of the wiring cover may damage the wire.

 **Prohibited**



 **WARNING**

 **Injury**  
**Fire**

 **Prohibited**

 **Practice**

- **You run the risk of injury or fire!**
- Do not connect AC power supply to any of the output terminals (U, V, and W).
- Make sure that the voltage of AC power supply matches the rated voltage of your inverter.

 **Electric shock**  
**Injury**

 **Practice**

- **You run the risk of electric shock and injury!**
- Before operating slide switch SW in the inverter, be sure to turn off the power supply.
- Since the inverter supports two modes of cooling-fan operation, the inverter power is not always off, even when the cooling fan is stopped. Therefore, be sure to confirm that the power supply is off before wiring.

 **Fire**

 **Prohibited**

 **Practice**

- **You run the risk of fire!**
- Do not use a single-phase input.
- Do not connect a resistor directly to any of the DC terminals (PD, P, and N).
- Do not use the magnetic contactor installed on the primary and secondary sides of the inverter to stop its operation.
- Tighten each screw to the specified torque.
- No screws must be left loose.
- Connect an earth-leakage breaker to the power input circuit.
- Use only the power cables, earth-leakage breaker, and magnetic contactors that have the specified capacity (ratings).

1.3.4 Precautions to Run and Test Running

 **DANGER**

 **Electric shock**  
**Fire**

 **Prohibited**

- **You run the risk of electric shock or fire!**
- While power is supplied to the inverter, do not touch any internal part or terminal of the inverter. Also do not check signals, or connect or disconnect any wire or connector.
- While power is supplied to the inverter, do not touch any internal part of the inverter. Also do not insert a material such as a rod and etc..

 **Electric shock**

 **Prohibited**

- **You run the risk of electric shock!**
- Be sure to close the terminal block cover before turning on the inverter power. Do not open the terminal block cover while power is being supplied to the inverter or voltage remains inside.
- Do not operate switches with wet hands.

 **Injury**  
**Fire**

 **Prohibited**

- **You run the risk of injury or fire!**
- While power is supplied to the inverter, do not touch the terminal of the inverter, even if it has stopped.

 **Injury**  
**Damage**

 **Prohibited**

- **You run the risk of injury and damage to machine.**
- Do not select the retry mode for controlling an elevating or traveling device because free-running status occurs in retry mode.

 **Injury**

 **Prohibited**

 **Practice**

- **You run the risk of injury!**
- If the retry mode has been selected, the inverter will restart suddenly after a break in the tripping status. Stay away from the machine controlled by the inverter when the inverter is under such circumstances. (Design the machine so that human safety can be ensured, even when the inverter restarts suddenly.)
- The [STOP] key on the operator keypad is effective only when its function is enabled by setting. Prepare an emergency stop switch separately.
- If an operation command has been input to the inverter before a short-term power failure, the inverter may restart operation after the power recovery. If such a restart may put persons in danger, design a control circuit that disables the inverter from restarting after power recovery.
- If an operation command has been input to the inverter before the inverter enters alarm status, the inverter will restart suddenly when the alarm status is reset. Before resetting the alarm status, make sure that no operation command has been input.

**WARNING**

 **Injury Damage**

 **Practice**

- You run the risk of injury and damage to machine.
- The inverter easily allows you to control the speed of operating motor. Confirm the capacity and ratings of the motor or machine before operating.
- When you run the motor at a high frequency, check and confirm to each manufactures of a permitting revolution of the respective motor and machine.
- Check the rotate motor direction, abnormal sound, and vibrations while operating.

 **Burn Injury**

 **Prohibited**

- You run the risk of burn injury.
- Inverter heat sink will heat up during operation. Do not touch the heat sink.

 **Injury**

 **Practice**

- You run the risk of injury!
- Install an external brake system if needed.

1.3.5 Precautions for Maintenance/Inspection

**DANGER**

 **Electric shock**

 **Practice**

 **Prohibited**

- You run the risk of electric shock!
- Before inspecting the inverter, be sure to turn off the power supply and wait for 10 minutes or more. (Before inspection, confirm that the Charge lamp on the inverter is off and the DC voltage between terminals P and N is 45 V or less.)
- Commit only a designated person to maintenance, inspection, and the replacement of parts. (Be sure to remove wristwatches and metal accessories, e.g., bracelets, before maintenance and inspection work and to use insulated tools for the work.)

1.3.6 Precautions for disposal

**DANGER**

 **Injury Explosion**

 **Practice**

 **Practice**

- You run the risk of injury and explosion!
- For disposal of the inverter, outsource to a qualified industrial waste disposal contractor. Disposing of the inverter on your own may result in an explosion of the capacitor or produce poisonous gas.
- Contact us or your distributor for fixing the inverter.
- A qualified waste disposer includes industrial waste collector/transporter and industrial waste disposal operator. Follow the act related to procedures stipulated in the waste management and public cleansing for disposing of the inverter.

1.3.7 Other Cautions

**DANGER**

 **Electric shock Fire Injury**

 **Prohibited**

- You run the risk of electric shock, fire and injury!
- Never modify the inverter.

**CAUTION**

 **Life cycle**

 **Practice**

- You run the risk of significantly shortening the life cycle of a product!
- Sterilizing and disinfecting a packaging wood materials use a means other than wood fumigation method. If the product is included in the fumigation treatment, electronic parts receive a critical damage from emitted gases or steams. Especially, halogen disinfectants (including fluorine, chlorine, bromine and iodine) can cause corrosion in the capacitor.

## 1.4 Compliance to European Directive (CE)

### 1.4.1 Caution for EMC (Electromagnetic Compatibility)

The SJ series P1 inverter conforms to requirements of Electromagnetic Compatibility (EMC) Directive (2014/30/EU). However, when using the inverter in Europe, you must comply with the following specifications and requirements to meet the EMC Directive and other standards in Europe:



**WARNING:** This equipment must be installed, adjusted, and maintained by qualified engineers who have expert knowledge of electric work, inverter operation, and the hazardous circumstances that can occur. Otherwise, personal injury may result.

1. Power supply requirements
  - a. Voltage fluctuation must be -15% to +10% or less.
  - b. Voltage imbalance must be  $\pm 3\%$  or less.
  - c. Frequency variation must be  $\pm 4\%$  or less.
  - d. Total harmonic distortion (THD) of voltage must be  $\pm 10\%$  or less.
2. Installation requirement
  - a. SJ series P1 includes a built-in EMC filter. The built-in EMC filter must be activated.
  - b. According to EN61800-3 it is mandatory to mention that any inverter with only C3 filter inside may NOT be connected to a low voltage public power supply in residential areas since for these installations C1 is required.
  - c. In case of external filter for C2, an additional note is required according to EN61800-3 that "this product may emit high frequency interference in residential areas which may require additional EMC measures".
  - d. According to the EN6100-3-12, an additional AC reactor or DC choke should be installed for reducing harmonics in power line.
3. Wiring requirements
  - a. A shielded wire (screened cable) must be used for motor wiring, and the length of the cable must be according to the following table (Table 1 on page 1-12).
  - b. The carrier frequency must be set according to the following table to meet an EMC requirement (Table1 on page 1-12).
  - c. The main circuit wiring must be separated from the control circuit wiring.
4. Environmental requirements  
(When an EMC filter is used)
  - a. SJ series P1 inverter that is activated built-in EMC filter must be according to SJ series P1 specifications.

Table 1

Model	Cat.	Cable Length (m)	Carrier Frequency (kHz)	Model	Cat.	Cable Length (m)	Carrier Frequency (kHz)
P1-00044-L (P1-004L)	C3	10	2	-	-	-	-
P1-00080-L (P1-007L)	C3	10	2	P1-00041-H (P1-007H)	C3	10	2
P1-00104-L (P1-015L)	C3	10	2	P1-00054-H (P1-015H)	C3	10	2
P1-00156-L (P1-022L)	C3	10	2	P1-00083-H (P1-022H)	C3	10	2
P1-00228-L (P1-037L)	C3	10	2	P1-00126-H (P1-037H)	C3	10	2
P1-00330-L (P1-055L)	C3	5	2	P1-00175-H (P1-055H)	C3	5	2
P1-00460-L (P1-075L)	C3	5	2	P1-00250-H (P1-075H)	C3	5	2
P1-00600-L (P1-110L)	C3	5	2	P1-00310-H (P1-110H)	C3	5	2
P1-00800-L (P1-150L)	C3	10	1	P1-00400-H (P1-150H)	C3	10	2
P1-00930-L (P1-185L)	C3	10	1	P1-00470-H (P1-185H)	C3	10	2
P1-01240-L (P1-220L)	C3	10	1	P1-00620-H (P1-220H)	C3	10	2
P1-01530-L (P1-300L)	C3	5	2	P1-00770-H (P1-300H)	C3	5	2
P1-01850-L (P1-370L)	C3	5	2	P1-00930-H (P1-370H)	C3	5	2
P1-02290-L (P1-450L)	C3	5	2	P1-01160-H (P1-450H)	C3	5	2
P1-02950-L (P1-550L)	C3	5	2	P1-01470-H (P1-550H)	C3	5	2
-	-	-	-	P1-01760-H (P1-750H)	C3	5	2
-	-	-	-	P1-02130-H (P1-900H)	C3	5	2
-	-	-	-	P1-02520-H (P1-1100H)	C3	5	2
-	-	-	-	P1-03160-H (P1-1320H)	C3	5	2

## 1.5 Compliance to UL standards

### 1.5.1 UL CAUTION

#### GENERAL:

SJ series Type P1 inverter is open type AC Inverter with three phase input and three phase output. It is intended to be used in an enclosure. It is used to provide both an adjustable voltage and adjustable frequency to the AC motor. SJ-P1 automatically maintains the required volts-Hz ratio as a function to control motor speed. It is multi-rated device and the ratings are selectable according to load types by operator with key pad operation.

#### Markings:

##### Maximum Surrounding Temperature:

- ND (Normal Duty): 50degC
- LD (Low Duty): 45degC
- VLD (Very Low Duty): 40degC

#### Storage Environment rating:

- 65degC (for transportation)

#### Instruction for installation:

- Pollution degree 2 environment and Overvoltage category III

#### Electrical Connections:

- See "7.5 Main circuit terminal wiring" of user's guide

#### Interconnection and wiring diagrams:

- See "7.7 Control circuit terminal wiring" of user's guide

#### Short circuit rating and overcurrent protection device rating:

##### P1-L series models

- Suitable for use on a circuit capable of delivering not more than 5,000 rms symmetrical amperes, 240 V maximum".

##### P1-H series models

- Suitable for use on a circuit capable of delivering not more than 5,000 rms symmetrical amperes, 500 V maximum".

#### Integral:

- Integral solid state short circuit protection does not provide branch circuit protection. Branch circuit protection must be provided in accordance with the National Electrical Code and any additional local codes

Terminal size and terminal tightening torque for field wiring:

Model	Load Type	Required Torque (N.m)	Conductor size (AWG)	Model	Load Type	Required Torque (N.m)	Conductor size (AWG)
P1-00044-L (P1-004L)	VLD	1.4	14				
	LD						
	ND						
P1-00080-L (P1-007L)	VLD	1.4	14	P1-00041-H (P1-007H)	VLD	1.4	14
	LD				LD		
	ND				ND		
P1-00104-L (P1-015L)	VLD	1.4	14	P1-00054-H (P1-015H)	VLD	1.4	14
	LD				LD		
	ND				ND		
P1-00156-L (P1-022L)	VLD	1.4	10	P1-00083-H (P1-022H)	VLD	1.4	14
	LD				LD		
	ND				ND		
P1-00228-L (P1-037L)	VLD	1.4	10	P1-00126-H (P1-037H)	VLD	1.4	12
	LD				LD		14
	ND				ND		
P1-00330-L (P1-055L)	VLD	3	8	P1-00175-H (P1-055H)	VLD	3	10
	LD				LD		12
	ND				ND		
P1-00460-L (P1-075L)	VLD	3	6	P1-00250-H (P1-075H)	VLD	3	8
	LD		8		LD		10
	ND				ND		
P1-00600-L (P1-110L)	VLD	4	4	P1-00310-H (P1-110H)	VLD	4	8
	LD		4		LD		
	ND		6		ND		
P1-00800-L (P1-150L)	VLD	2.5 – 3.0	3	P1-00400-H (P1-150H)	VLD	4	8
	LD		3		LD		
	ND		4		ND		
P1-00930-L (P1-185L)	VLD	2.5 – 3.0	1	P1-00470-H (P1-185H)	VLD	4	6
	LD		2		LD		8
	ND		3		ND		
P1-01240-L (P1-220L)	VLD	5.5 – 6.6	2/0	P1-00620-H (P1-220H)	VLD	4	4
	LD		1/0		LD		6
	ND		1		ND		
P1-01530-L (P1-300L)	VLD	6.0	Parallel of 1/0	P1-00770-H (P1-300H)	VLD	6.0	1
	LD				LD		2
	ND				ND		3
P1-01850-L (P1-370L)	VLD	15.0	Parallel of 1/0	P1-00930-H (P1-370H)	VLD	15.0	1
	LD		Parallel of 1/0		LD		
	ND		4/0		ND		
P1-02290-L (P1-450L)	VLD	6.0 – 10.0	Parallel of 2/0	P1-01160-H (P1-450H)	VLD	6.0 – 10.0	Parallel of 2/0
	LD		Parallel of 1/0		LD		Parallel of 1/0
	ND		Parallel of 1/0		ND		1
P1-02950-L (P1-550L)	VLD	19.6	Parallel of 3/0	P1-01470-H (P1-550H)	VLD	6.0 – 10.0	Parallel of 1/0
	LD		Parallel of 3/0		LD		Parallel of 1/0
	ND		350kcmil		ND		2/0

- Use 75degC only for temperature rating of field wiring.
- Use Copper conductors only.

Required protection by Fuse and circuit-breakers:

P1-L series models

Model	Type	Fuse		Circuit Breaker	
		Maximum Rating		Maximum Rating	
		Voltage (V)	Current (A)	Voltage (V)	Current (A)
P1-00044-L (P1-004L)	Class J or T	600	50	-	-
P1-00080-L (P1-007L)	Class J or T	600	50	-	-
P1-00104-L (P1-015L)	Class J or T	600	50	-	-
P1-00156-L (P1-022L)	Class J or T	600	50	-	-
P1-00228-L (P1-037L)	Class J or T	600	50	-	-
P1-00330-L (P1-055L)	Class J or T	600	100	-	-
P1-00460-L (P1-075L)	Class J or T	600	150	-	-
P1-00600-L (P1-110L)	Class J or T	600	150	-	-
P1-00800-L (P1-150L)	Class J or T	600	150	-	-
P1-00930-L (P1-185L)	Class J or T	600	200	-	-
P1-01240-L (P1-220L)	Class J or T	600	200	-	-
P1-01530-L (P1-300L)	Class J or T	600	300	-	-
P1-01850-L (P1-370L)	Class J or T	600	300	-	-
P1-02290-L (P1-450L)	Class J or T	600	300	-	-
P1-02950-L (P1-550L)	Class J or T	600	350	-	-

Model	Type	Fuse		Circuit Breaker	
		Maximum Rating		Maximum Rating	
		Voltage (V)	Current (A)	Voltage (V)	Current (A)
P1-00041-H (P1-007H)	Class J or T	600	30	-	-
P1-00054-H (P1-015H)	Class J or T	600	30	-	-
P1-00083-H (P1-022H)	Class J or T	600	30	-	-
P1-00126-H (P1-037H)	Class J or T	600	30	-	-
P1-00175-H (P1-055H)	Class J or T	600	75	-	-
P1-00250-H (P1-075H)	Class J or T	600	75	-	-
P1-00310-H (P1-110H)	Class J or T	600	75	-	-
P1-00400-H (P1-150H)	Class J or T	600	100	-	-
P1-00470-H (P1-185H)	Class J or T	600	100	-	-
P1-00620-H (P1-220H)	Class J or T	600	100	-	-
P1-00770-H (P1-300H)	Class J or T	600	200	-	-
P1-00930-H (P1-370H)	Class J or T	600	200	-	-
P1-01160-H (P1-450H)	Class J or T	600	200	-	-
P1-01470-H (P1-550H)	Class J or T	600	250	-	-



# Chapter 2

## Installation and Wiring

### 2.1 Check the Inverter

Check the contents in the package, and confirm the inverter model with a specification label.

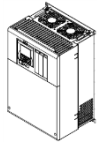

Inverter



Basic Guide  
(This document)

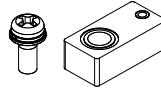

M3×8 screw 4pcs  
Spacer 4 pcs  
P1-01240-L(P1-220L)



Eye bolts for hanging the inverter  
◇ P1-01850L/-00930H or above  
(enclosed in the package)

The model of the product is as follows:

E.g.: 200V class input voltage for Japan

Applicable motor capacity for ND rating is 3.7kW

ND rated current 17.5A

LD rated current 19.6A

VLD rated current 22.8A

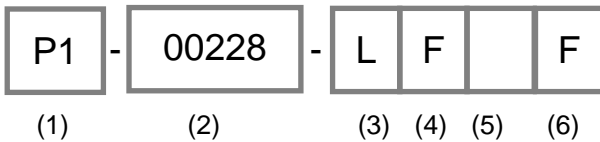

- (1) Series name P1
- (2) Motor maximum rated current (at VLD rated current  
00001: 0.1A to 99999: 9999.9A
- (3) Input power specification  
L: three-phase 200V class;  
H: three-phase 400V class
- (4) Panel  
B: no operator keypad equipped;  
F: panel equipped
- (5) Region (None): Japan;  
E: Europe/Southeast Asia;  
U: North America;  
C: China  
◇ In case of (None), blank field is omitted.
- (6) Integrated noise filter  
F: integrated noise filter equipped;  
CB: conduit box equipped  
◇ When both F and CB are equipped, it is indicated as FCB.

- Specification label example  
Description example for P1-00228-LFF  
(\* ) means eigenvalues

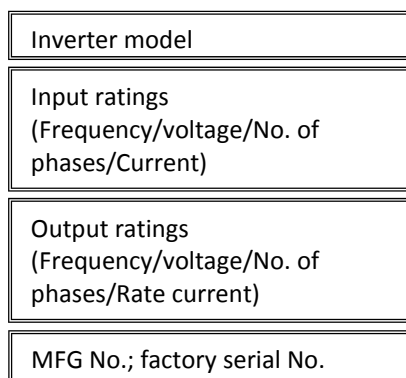

<b>HITACHI</b> INVERTER		Ver.2.00
SJ series type P1		
Model: P1-00228-LFF		
Input/Entrée:50Hz,60Hz 200-240V 3ph 27.1/23.3/20.8A		
Output/Sortie:0-590Hz 200-240V 3ph 22.8/19.6/17.5A		
MFG No. 62AA*****	BB001	Date:****
Hitachi Industrial Equipment Systems Co., Ltd.		MADE IN JAPAN
		NE18361-***

- ◇ Configuration and description contents vary depending on the model.  
Refer to User's Guide for more details.
- ◇ If the inverter is shipped incorporated with optional products, optional instruction will be enclosed.

◇ P1-00228-LFF example illustration in below.

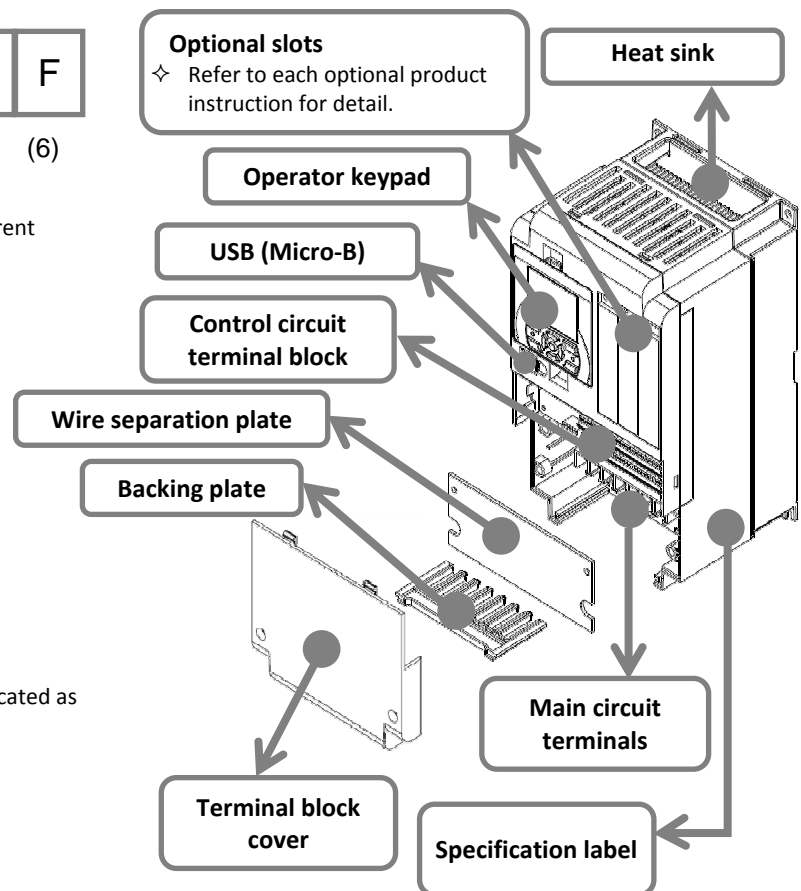

## 2.2 Install the Inverter



### Transportation

- The inverter is made of plastics component. When carrying the inverter, handle it carefully to prevent damage to the parts.
- Do not carry the inverter by holding the front or terminal block cover. Doing so may cause the inverter to fall.
- Do not install and operate the inverter if it is damaged or its parts are missing.



### Ambient temperature

- Avoid installing the inverter in a place where the ambient temperature goes above or below the allowable range defined by the standard inverter specification.

Ambient temperature:

ND rated	: -10 to 50°C
LD rated	: -10 to 45°C
VLD rated	: -10 to 40°C

- Keep sufficient space around the inverter. Measure the temperature in a position about 5 cm distant from the bottom-center point of the inverter, and check that the measured temperature is within the allowable range. Operating the inverter at a temperature outside this range will shorten the inverter life (especially the capacitor life), resulting in damage to the inverter.



### Do not install on a high temperature, high humidity or easily condensation area

- Avoid installing the inverter in a place where the relative humidity goes above or below the range (20% to 90% RH), as defined by the standard inverter specification. Avoid a place where the inverter is subject to condensation.
- Condensation inside the inverter will result in short circuits, which may cause damage to the inverter. Also avoid places where the inverter is exposed to direct sunlight.



### Install inverter on nonflammable (e.g. metal) surface.

- The inverter will reach a high temperature (up to about 150°C) during operation. Install the inverter on a vertical wall surface made of nonflammable material (e.g., metal) to avoid the risk of fire.
- In particular, keep sufficient distance between the inverter and other heat sources (e.g., braking resistors and reactors) if they are installed in the vicinity.

For  
**P1-00044-L to P1-02950-L**  
 (P1-004L to P1-550L)  
 or  
**P1-00041-H to P1-01800-H**  
 (P1-007H to P1-550H)

For  
**P1-02160-H to P1-03610-H**  
 (P1-750H to P1-1320H)

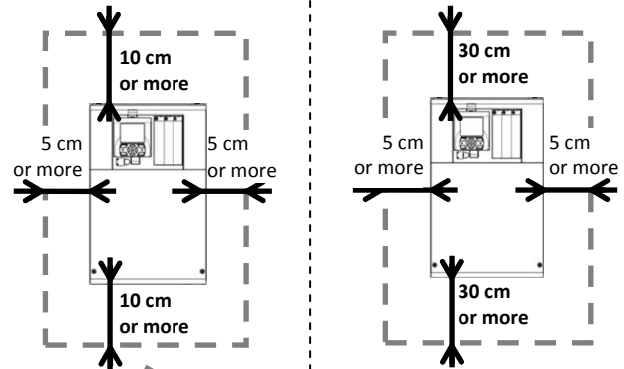

- ◇ In order to replace life cycle parts on following models require a clearance of 22cm or more:
  - P1-00800-L (P1-150L) to P1-01240-L (P1-220L)
  - P1-00380-H (P1-150H) to P1-00620-H (P1-220H)
- ◇ In order to replace life cycle parts on following models is required to remove the installed units:
  - P1-00044-L (P1-004L) to P1-00600-L (P1-110L)
  - P1-00041-H (P1-007H) to P1-00310-H (P1-110H)

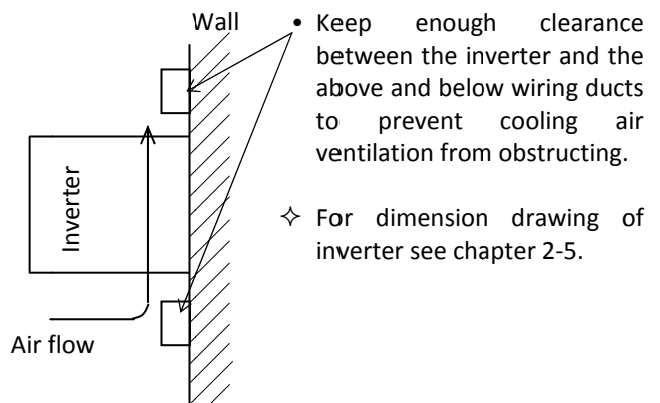

- Keep enough clearance between the inverter and the above and below wiring ducts to prevent cooling air ventilation from obstructing.
- ◇ For dimension drawing of inverter see chapter 2-5.

### ⚠ Installation environment

- Avoid installing the inverter in a place where the inverter is subject to dust, corrosive gases, explosive gases, flammable gases, grinding fluid mist, or salt water.
- Foreign particles entering the inverter will cause of failure. If you use the inverter in a considerably dusty environment, install the inverter inside a totally enclosed panel.

### ⚠ Installation method and position

- Install the inverter vertically and securely with screws or bolts on a surface that is free from vibrations and that can bear the inverter weight.
- If the inverter is not installed properly, its cooling performance may be degraded and tripping or inverter damage may result.

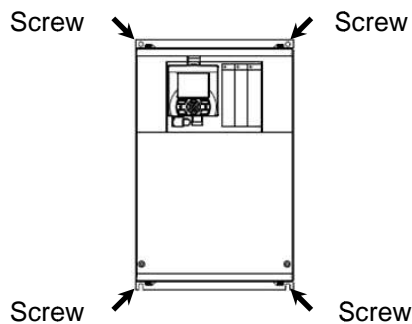

### ⚠ Mounting in an enclosure

- When mounting multiple inverters in an enclosure with a ventilation fan, carefully design the layout of the ventilation fan, air intake port, and inverters. An inappropriate layout will reduce the inverter-cooling effect and raise the ambient temperature. Plan the layout properly so that the inverter ambient temperature will remain within the range specified in the specification table.

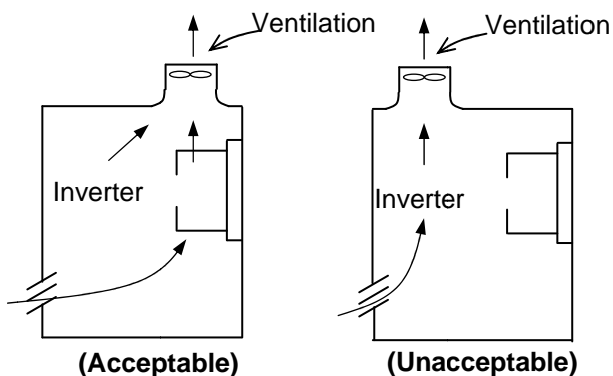

Position of ventilation fan

- ✧ When the inverter is installed below ventilation fan, the incoming dust may adhere to the inverter. Place in a position to avoid this falling dust.

### ⚠ Reduction of enclosure size

- External heat sink installation may reduce internal heat emission and reduce the enclosure size.
- External heat sink mounting for the inverter P1-00044-L to P1-00228-L (P1-004L to P1-037L) and P1-00041-H to P1-00126-H (P1-007H to P1-037H) requires an optional metal fitting.
- Other models than above can be installed with the originally attached metal fitting. To mount the inverter for external heat sink, cut out the enclosure panel according to the specified cutting dimensions.
- The cooling section (including the heat sink) positioned outside the enclosure has a cooling fan. Therefore, do not place the enclosure in any environment where it is exposed to water drops, oil mist, or dust.
- The heat sink part reaches a high temperature. Install a protection cover as needed.

### 2.3 Dimension Drawing

◇ If you add optional parts to the inverter, some extra space is required in the direction of the depth of the inverter depending on the wiring layout. Keep a clearance of 50 mm or more. For details, refer to the instruction manual for each optional product.

(Eg.) See "Chapter 7 Specifications" for details. VLD rated current for 00046-L(004L) is 4.6A, (ND rated motor capacity is 0.4kW), and L indicates 200V class, while H indicates 400V class.

Model P1-***** (P1-*****)			
200V class: 00044-L(004L), 00080-L(007L), 0104-L(015L), 00156-L(022L), 00228-L(037L)			
400V class: 00041-H(007H), 00054-H(015H), 00083-H(022H), 00126-H(037H)			
Dimension	W(mm)	H(mm)	D(mm)
	150	255	140

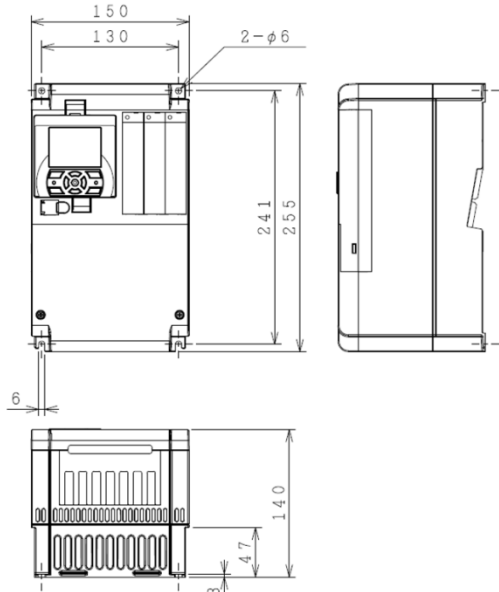

Model (P1-*****)			
200V class: 00800-L(150L), 00930-L(185L), 01240-L(220L)			
400V class: 00400-H(150H), 00470-H(185H), 00620-H(220H)			
Dimension	W(mm)	H(mm)	D(mm)
	245	390	190

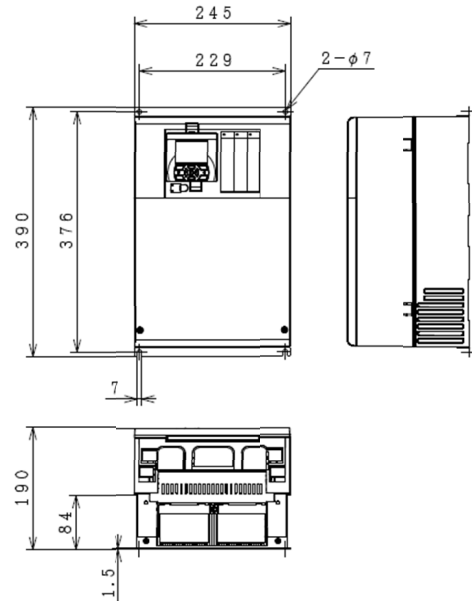

Model P1-***** (P1-*****)			
200V class: 00330-L(055L), 00460-L(075L), 00600-L(110L)			
400V class: 00175-H(055H), 00250-H(075H), 00310-H(110H)			
Dimension	W(mm)	H(mm)	D(mm)
	210	260	170

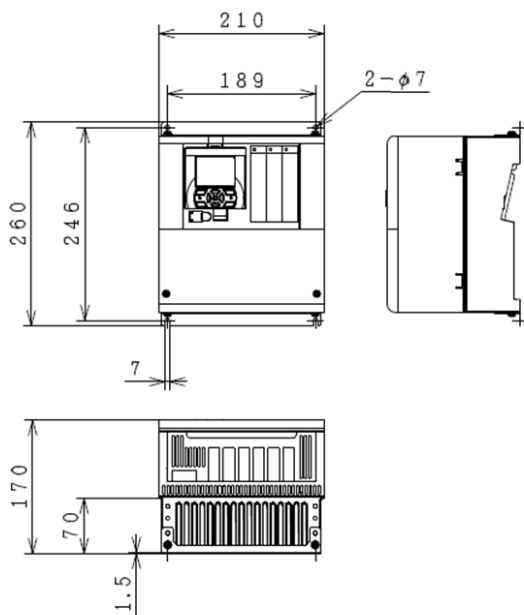

Model P1-***** (P1-*****)			
200V class: 01530-L(300L)			
400V class: 00770-H(300H)			
Dimension	W(mm)	H(mm)	D(mm)
	540	300	195

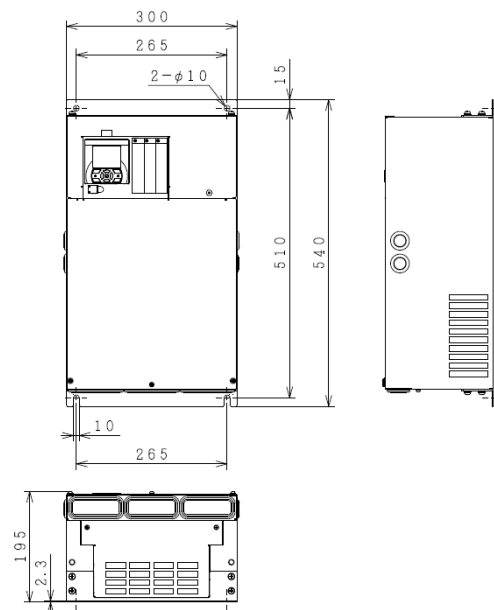

Model P1-***** (P1-*****)			
200V class: 01850-L(370L), 02290-L(450L), 400V class: 00930-H(370H),01160-H(450H),01470-H(550H)			
Dimension	W(mm)	H(mm)	D(mm)
	550	390	250

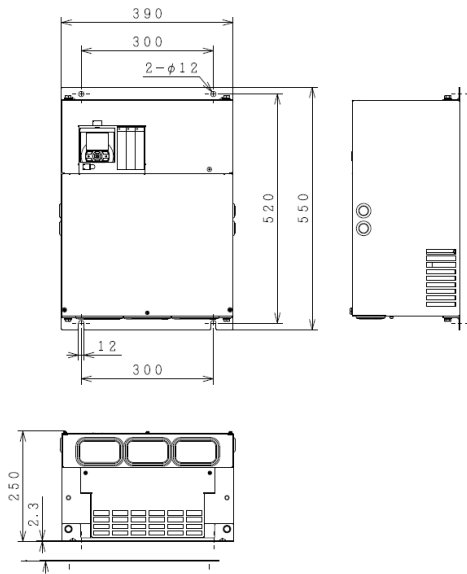

Model P1-***** (P1-*****)			
400V class: 01760-H(750H), 02130-H(900H)			
Dimension	W(mm)	H(mm)	D(mm)
	700	390	270

(in preparation)

Model P1-***** (P1-*****)			
200V class: 02950-L(550L)			
Dimension	W(mm)	H(mm)	D(mm)
	700	480	250

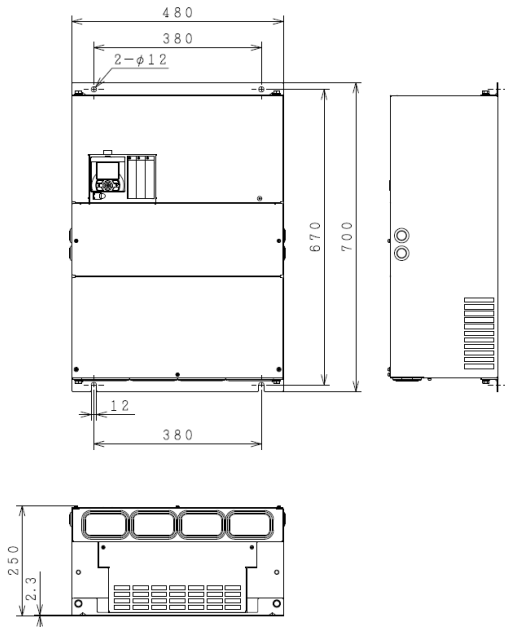

Model P1-***** (P1-*****)			
400V class: 02520-H(1100H), 03160-H(1320H)			
Dimension	W(mm)	H(mm)	D(mm)
	740	480	270

(in preparation)

2.4 Inverter Wiring

Applicable peripheral equipment



Notes:

- The description of peripheral equipment is for Hitachi 3-phase, 4-pole squirrel-cage motor.
- Select breakers with proper interrupting capacity. (Use inverter-ready breakers)
- Use earth-leakage circuit breakers (ELB or MCB) to ensure safety.
- Use copper electric wire (HIV cable) with allowable temperature rating 75°C or more.
- If the power line exceeds 20 m, use cable with major wire size for the power line.
- Tighten each terminal screw with the specified tightening torque.  
Loose terminal screws may cause short circuits and fire.  
Excessive tightening torque may cause damage to the terminal block or inverter body.
- When selecting a rated sensitivity current for earth-leakage circuit breaker, use a separated breaker considering a total cable length of between Inverter–Power supply and Inverter–Motor distance. Do not use a high-speed type of earth-leakage circuit breaker. Use a delayed-type circuit breaker, because the high-speed type may malfunction.
- When using a CV cable for wiring through a metal conduit, the average current leakage would be 30mA/km.
- When using a high relative dielectric constant cable such as IV cable, the leakage current is about eight times as high as the standard cable. Therefore, when using an IV cable, use ELCB with rated sensitivity current by eight times higher in the table below. If the total cable length exceeds 100 m, use a CV cable.
- Do not pull the power line cable after wiring. Doing so may cause screw loosening.

Total cable length	Sensitivity current (mA)
100 m or less	50
300 m or less	100

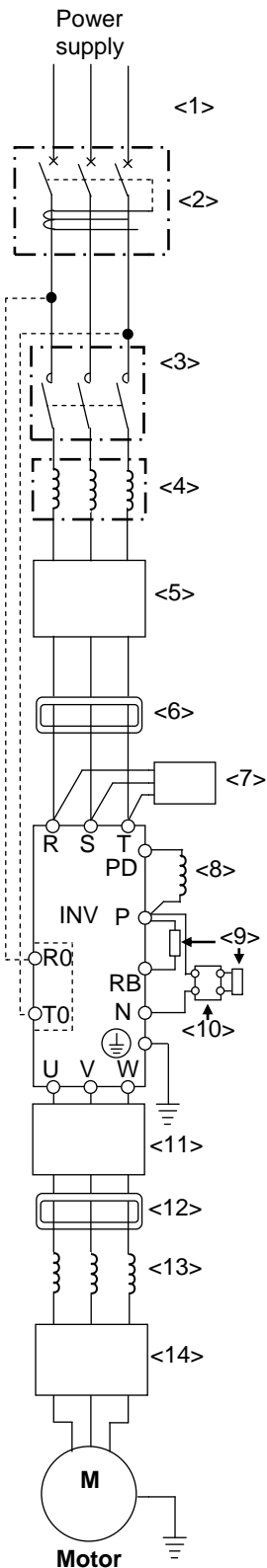

No.	Name	Function
<1>	Electric wire	See "Recommended cable gauges, wiring accessories, and crimp terminals" on Page 2-9.
<2>	Earth-leakage circuit breaker ELCB or MCCB	
<3>	Magnetic contactor MC	
<4>	Input AC reactor (For harmonic control, power supply voltage imbalance exceeds 3% or more, or when the power supply capacity is over 500 kVA or more, or when the power voltage may change rapidly. This reactor also improves the power factor.)	Use input reactor for harmonic wave control, or when power supply voltage imbalance exceeds 3% or more, or when the power supply capacity is over 500 kVA or more, or when the power voltage may change rapidly. This reactor also improves the power factor.
<5>	Noise filter for inverter	This noise filter reduces the conductive noise that is generated by the inverter and transmitted in cables. Connect this noise filter to the primary side (input side) of the inverter.
<6>	Radio noise filter (Zero-phase reactor)	The inverter may generate radio noise through power supply wiring during operation. Use this noise filter to reduce the radio noise (radiant noise).
<7>	Radio noise filter on the input side (Capacitor filter)	Use this noise filter to reduce the radiant noise radiated from input cables.
<8>	DC Choke	Use DC chokes to reduce the harmonic generated by the inverter.
<9>	Braking resistor	Use these devices to increase the braking torque of the inverter for operation in which the inverter turns the connected load on and off very frequently or decelerates the load running with a high moment of inertia.
<10>	Regenerative braking unit	
<11>	Noise filter on the output side	Connect this noise filter between the inverter and motor to reduce the radiant noise radiated from cables for the purpose of reducing the electromagnetic interference with radio and television reception and preventing malfunctions of measuring equipment and sensors.
<12>	Radio noise filter (Zero-phase reactor)	Use this noise filter to reduce the noise generated on the output side of the inverter. (This noise filter can be used on both the input and output sides.)
<13>	Output AC reactor For reducing vibrations and preventing thermal relay malfunction	Inverter driven motor may cause large vibrations compared to commercial power supply direct start motor. Connect Output AC reactor between inverter and motor to lessen the pulsation of motor. Also, connect output AC reactor, when the cable length between inverter and motor is longer (10 m or more), to prevent thermal relay malfunction due to the harmonic waves generated by switching operation of inverter. Note that the thermal relay can be replaced with a current sensor to avoid the malfunction.
<14>	LCR filter	Connect this noise filter between the inverter and motor to convert the inverter output into a sinusoidal waveform and to reduce the motor vibration, motor noise and the radiant noise radiated from cables. Surge voltage can be also controlled.

### 2.5 Wiring of the main circuit

Wire the main circuit of the inverter.  
 The following illustration shows the power supply and wiring connections to a motor only.  
 Open a terminal block cover to wire the terminal block in the main circuit.

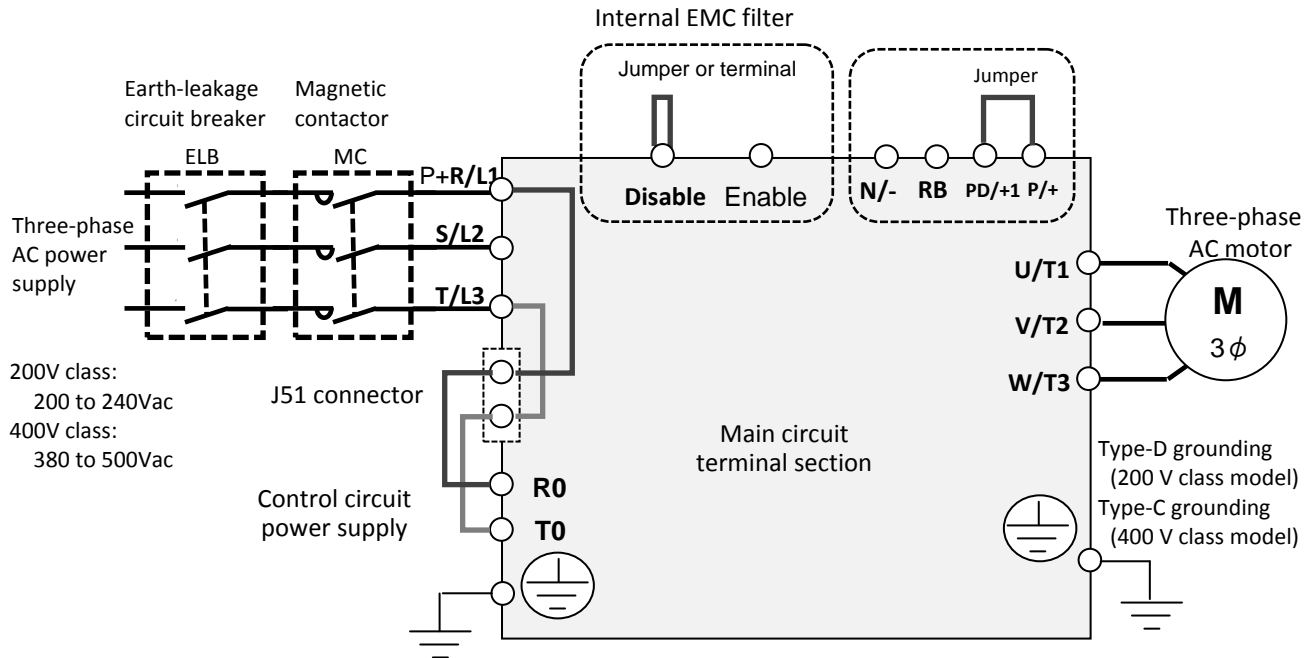

#### Explanation of main circuit terminal block

Symbol	Terminal name	Description
R,S,T (L1,L2,L3)	Main power input	Connect to the AC power supply. Leave these terminals unconnected when using a regenerative converter.
U,V,W (T1,T2,T3)	Inverter output	Connect a Three-phase motor.
PD,P (+1,+)	DC choke connection terminal	Remove the PD-P jumper from terminals, and connect the optional DC choke for power factor improvement.
P,RB (+,RB)	External chopper braking resistor connection terminal	Connect the optional external braking resistor. See “Chapter 7 Specifications” for built-in braking circuit inverter models.
P,N (+,-)	Regenerative braking unit connection terminal	Connect the optional regenerative braking unit.
⊕	Inverter ground terminal	This serves as a ground terminal for the inverter chassis to ground. Connect 200V class and 400V class models to Type-D grounding and Type-C grounding, respectively.

- ◇ See “Chapter 1 Safety Instructions” for response to CE and UL standards.
- ◇ The screw size may vary depending on terminal. Refer to Page 2-8/2-9 for the size of the terminal screw for the power line cable while for other terminals, refer to the drawings of the wiring on Page 2-13 or later.
- ◇ The tables on Page 2-8/2-9 list the specifications of cables, crimp terminals, and terminal screw tightening torques for reference.
- ◇ Recommended wire gauges vary depending on the rated load settings (ND/LD/VLD).

## 2.6 Recommended wire gauges, wiring accessories, and crimp terminals

■ 200V class

Applicable P1 inverter model P1-*****	Rating setting	Power line cable AWG(mm <sup>2</sup> ) R,S,T,U,V,W, P,PD,N	Grounding cable AWG(mm <sup>2</sup> )	External braking resistor between P and RBAWG(mm <sup>2</sup> )	Power line cable Terminal screw size	Crimp terminal	Tightening torque N•m	
P1-00044-L (P1-004L)	ND	14(2.1)	14(2.1)	14(2.1)	M4	2-4/2-4	1.4	
	LD							
	VLD							
P1-00080-L (P1-007L)	ND	14(2.1)	14(2.1)	14(2.1)	M4	2-4/2-4	1.4	
	LD							
	VLD							
P1-00104-L (P1-015L)	ND	14(2.1)	14(2.1)	14(2.1)	M4	2-4/2-4	1.4	
	LD							
	VLD							
P1-00156-L (P1-022L)	ND	14(2.1)	14(2.1)	14(2.1)	M4	2-4/2-4	1.4	
	LD					5.5-4/5.5-4		
	VLD	10(5.3)	10(5.3)	10(5.3)				
P1-00228-L (P1-037L)	ND	10(5.3)	10(5.3)	10(5.3)	M4	5.5-4/5.5-4	1.4	
	LD							
	VLD							
P1-00330-L (P1-055L)	ND	8(8.4)	8(8.4)	8(8.4)	M5	8-5/8-5	3.0	
	LD							
	VLD							
P1-00460-L (P1-075L)	ND	8(8.4)	6(13.3)	8(8.4)	M5	8-5/8-5	3.0	
	LD					14-5/8-5		
	VLD	6(13.3)	6(13.3)	6(13.3)				
P1-00600-L (P1-110L)	ND	6(13.3)	6(13.3)	6(13.3)	M6	14-6/14-6	4.0	
	LD	4(21.2)				22-6/14-6		
	VLD	4(21.2)				4(21.2)		4(21.2)
P1-00800-L (P1-150L)	ND	4(21.2)	6(13.3)	4(21.2)	M6	22-6/14-6	2.5 to 3.0	
	LD	3(26.7)				3(26.7)		38-6/14-6
	VLD							
P1-00930-L (P1-185L)	ND	3(26.7)	6(13.3)	3(26.7)	M6	38-6/14-6	2.5 to 3.0	
	LD	2(33.6)				60-6/14-6		
	VLD	1(42.4)						1(42.4)
P1-01240-L (P1-220L)	ND	1(42.4)	6(13.3)	1(42.4)	M8	60-8/14-6	5.5 to 6.6	
	LD	1/0(53.5)				70-8/14-6		
	VLD	2/0(67.4)				2/0(67.4)		
P1-01530-L (P1-300L)	ND	2/0(67.4)	4(21.2)	—	M8	70-8/22-8	6.0	
	LD	1/0×2(53.5×2)				60-8/22-8		
	VLD							
P1-01850-L (P1-370L)	ND	4/0(107.2)	4(21.2)	—	M8	100-8/22-8	15.0	
	LD	1/0×2(53.5×2)				60-8/22-8		
	VLD							
P1-02290-L (P1-450L)	ND	1/0×2(53.5×2)	4(21.2)	—	M8	60-8/22-8	6.0 to 10.0	
	LD	2/0×2(67.4×2)				70-8/22-8		
	VLD							
P1-02950-L (P1-550L)	ND	350kc(177)	3(26.7)	—	M10	180-8/38-8	19.6	
	LD	3/0×2(85.0×2)				80-8/38-8		
	VLD							

◇ The wire gauges in the above table shows the designed values based on HIV cables (with thermal resistance of 75°C).

◇ Please use the round type crimp terminals (for the UL standard) suitable for the use electric wire when you connect the electric wire with the main circuit terminal block. Please put on pressure to the crimp terminals with a crimp tool that the crimp terminal maker recommends.



## ■ 400V class

Applicable P1 inverter model P1-*****	Rating setting	Power line cable AWG(mm <sup>2</sup> ) R,S,T,U,V,W, P,PD,N	Grounding cable AWG(mm <sup>2</sup> )	External braking resistor between P and RBAWG(mm <sup>2</sup> )	Power line cable Terminal screw size	Crimp terminal	Tightening torque N•m
P1-00041-H (P1-007H)	ND	14(2.1)	14(2.1)	14(2.1)	M4	2-4/2-4	1.4
	LD						
	VLD						
P1-00054-H (P1-015H)	ND	14(2.1)	14(2.1)	14(2.1)	M4	2-4/2-4	1.4
	LD						
	VLD						
P1-00083-H (P1-022H)	ND	14(2.1)	14(2.1)	14(2.1)	M4	2-4/2-4	1.4
	LD						
	VLD						
P1-00126-H (P1-037H)	ND	14(2.1)	14(2.1)	14(2.1)	M4	2-4/2-4	1.4
	LD						
	VLD	12(3.3)	12(3.3)	12(3.3)		5.5-4/5.5-4	
P1-00175-H (P1-055H)	ND	12(3.3)	12(3.3)	12(3.3)	M5	5.5-5/5.5-5	3.0
	LD						
	VLD	10(5.3)	10(5.3)	10(5.3)			
P1-00250-H (P1-075H)	ND	10(5.3)	10(5.3)	10(5.3)	M5	5.5-5/5.5-5	3.0
	LD						
	VLD	8(8.4)	8(8.4)	8(8.4)		8-5/8-5	
P1-00310-H (P1-110H)	ND	8(8.4)	8(8.4)	8(8.4)	M6	8-6/8-6	4.0
	LD						
	VLD						
P1-00400-H (P1-150H)	ND	8(8.4)	8(8.4)	8(8.4)	M6	8-6/8-6	4.0
	LD						
	VLD						
P1-00470-H (P1-185H)	ND	8(8.4)	8(8.4)	8(8.4)	M6	8-6/8-6	4.0
	LD	6(13.3)		6(13.3)		14-6/8-6	
	VLD						
P1-00620-H (P1-220H)	ND	6(13.3)	8(8.4)	6(13.3)	M6	14-6/8-6	4.0
	LD	4(21.2)		4(21.2)		22-6/8-6	
	VLD						
P1-00770-H (P1-300H)	ND	3(26.7)	6(13.3)	-	M8	38-8/14-8	6.0
	LD	2(33.6)					
	VLD	1(42.4)				60-8/14-8	
P1-00930-H (P1-370H)	ND	1(42.4)	6(13.3)	-	M8	60-8/14-8	15.0
	LD						
	VLD						
P1-01160-H (P1-450H)	ND	1(42.4)	6(13.3)	-	M8	60-8/14-8	6.0~10.0
	LD	1/0(53.5)				70-8/14-8	
	VLD	2/0(67.4)					
P1-01800-H (P1-550H)	ND	2/0(67.4)	4(21.2)	-	M8	70-8/22-8	6.0~10.0
	LD	1/0×2(53.5×2)				60-8/22-8	
	VLD						
P1-02160-H (P1-750H)	ND	—	—	—	—	—	—
	LD	—	—	—	—	—	—
	VLD	—	—	—	—	—	—
P1-02600-H (P1-900H)	ND	—	—	—	—	—	—
	LD	—	—	—	—	—	—
	VLD	—	—	—	—	—	—
P1-03250-H (P1-1100H)	ND	—	—	—	—	—	—
	LD	—	—	—	—	—	—
	VLD	—	—	—	—	—	—
P1-03610-H (P1-1320H)	ND	—	—	—	—	—	—
	LD	—	—	—	—	—	—
	VLD	—	—	—	—	—	—

◇ The wire gauges in the above table shows the designed values based on HIV cable (with thermal resistance of 75°C).

◇ Please use the round type crimp terminals (for the UL standard) suitable for the use electric wire when you connect the electric wire with the main circuit terminal block. Please put on pressure to the crimp terminals with a crimp tool that the crimp terminal maker recommends.

## 2.7 Applicable circuit breaker

### ■ 200V class

- For ND rating

Model P1-***** (P1-****)	Applicable Motor (kW)	Applicable devices (Input Voltage 200~220V)							
		Without reactor (DCL or ACL)				With reactor (DCL or ACL)			
		Earth-leakage breaker (ELB)		Magnetic Contactor (MC)		Earth-leakage breaker (ELB)		Magnetic Contactor (MC)	
		Example model	Current Rate	AC-1	AC-3	Example model	Current Rate	AC-1	AC-3
P1-00044-L(P1-004L)	0.4	EB-30E	5	HS8	HS8	EB-30E	5	HS8	HS8
P1-00080-L(P1-007L)	0.75	EB-30E	10	HS8	HS8	EB-30E	5	HS8	HS8
P1-00104-L(P1-015L)	1.5	EB-30E	15	HS8	HS8	EB-30E	10	HS8	HS8
P1-00156-L(P1-022L)	2.2	EB-30E	20	HS8	HS8	EB-30E	15	HS8	HS8
P1-00228-L(P1-037L)	3.7	EB-30E	30	HS8	HS20	EB-30E	20	HS8	HS20
P1-00330-L(P1-055L)	5.5	EB-50E	40	HS20	HS25	EB-30E	30	HS8	HS20
P1-00460-L(P1-075L)	7.5	EB-50E	50	HS35	HS35	EB-50E	40	HS20	HS25
P1-00600-L(P1-110L)	11	EB-100E	75	HS50	H65C	EB-100E	60	HS35	HS50
P1-00800-L(P1-150L)	15	RXK125-S	125	H65C	H80C	EB-100E	100	HS50	H65C
P1-00930-L(P1-185L)	18.5	RXK125-S	125	H80C	H100C	EB-100E	100	HS50	H65C
P1-01240-L(P1-220L)	22	EXK225	150	H80C	H125C	RXK125-S	125	H65C	H80C
P1-01530-L(P1-300L)	30	EXK225	200	H125C	H150C	EXK225	150	H80C	H125C
P1-01850-L(P1-370L)	37	RXK250-S	250	H150C	H200C	EXK225	200	H100C	H125C
P1-02290-L(P1-450L)	45	EX400	300	H200C	H250C	EXK225	225	H125C	H150C
P1-02950-L(P1-550L)	55	EX400	400	H200C	H300C	EX400	300	H150C	H250C

- For LD/VLD rating

Model P1-***** (P1-****)	Applicable Motor (kW)	Applicable devices (Input Voltage 200~220V)							
		Without reactor (DCL or ACL)				With reactor (DCL or ACL)			
		Earth-leakage breaker (ELB)		Magnetic Contactor (MC)		Earth-leakage breaker (ELB)		Magnetic Contactor (MC)	
		Example model	Current Rate	AC-1	AC-3	Example model	Current Rate	AC-1	AC-3
P1-00044-L(P1-004L)	0.75	EB-30E	10	HS8	HS8	EB-30E	5	HS8	HS8
P1-00080-L(P1-007L)	1.5	EB-30E	15	HS8	HS8	EB-30E	10	HS8	HS8
P1-00104-L(P1-015L)	2.2	EB-30E	20	HS8	HS8	EB-30E	15	HS8	HS8
P1-00156-L(P1-022L)	3.7	EB-30E	30	HS8	HS20	EB-30E	20	HS8	HS20
P1-00228-L(P1-037L)	5.5	EB-50E	40	HS20	HS25	EB-30E	30	HS8	HS20
P1-00330-L(P1-055L)	7.5	EB-50E	50	HS35	HS35	EB-50E	40	HS20	HS25
P1-00460-L(P1-075L)	11	EB-100E	75	HS50	H65C	EB-100E	60	HS35	HS50
P1-00600-L(P1-110L)	15	RXK125-S	125	H65C	H80C	EB-100E	100	HS50	H65C
P1-00800-L(P1-150L)	18.5	RXK125-S	125	H80C	H100C	EB-100E	100	HS50	H65C
P1-00930-L(P1-185L)	22	EXK225	150	H80C	H125C	RXK125-S	125	H65C	H80C
P1-01240-L(P1-220L)	30	EXK225	200	H125C	H150C	EXK225	150	H80C	H125C
P1-01530-L(P1-300L)	37	RXK250-S	250	H150C	H200C	EXK225	200	H100C	H125C
P1-01850-L(P1-370L)	45	EX400	300	H200C	H250C	EXK225	225	H125C	H150C
P1-02290-L(P1-450L)	55	EX400	400	H200C	H300C	EX400	300	H150C	H250C
P1-02950-L(P1-550L)	75	EX600B	500	H300C	H400C	EX400	400	H200C	H300C

- ◇ Device model name on above table shows example selection. The device selection should be made in base on rated current, short circuit current capability and accordance to the local electrical legislation.
- ◇ Applicable motor capacity is based on Hitachi 200Vac, 60Hz, 4 pole IE3 motor.
- ◇ Refer to the wire gauge table on chapter 2-8 for power line cable.
- ◇ Electrical endurance for AC-1 magnetic contactor is 500000 times, however, for emergency stop in motor operation will be only 25 times.
- ◇ Select AC-3 class magnetic contactor for inverter output for application which has an emergency stop or commercial power line operation.
- ◇ When selecting oversize inverter capacity compare to motor rating, select magnetic contactor according to the inverter capacity

## ■ 400V class

- For ND rating

Model P1-***** (P1-****)	Applicable Motor (kW)	Applicable devices (Input Voltage 400~440V)							
		Without reactor (DCL or ACL)				With reactor (DCL or ACL)			
		Earth-leakage breaker (ELB)		Magnetic Contactor (MC)		Earth-leakage breaker (ELB)		Magnetic Contactor (MC)	
		Example model	Current Rate	AC-1	AC-3	Example model	Current Rate	AC-1	AC-3
P1-00041-H(P1-007H)	0.75	EX50C	5	HS8	HS8	EX50C	5	HS8	HS8
P1-00054-H(P1-015H)	1.5	EX50C	10	HS8	HS8	EX50C	5	HS8	HS8
P1-00083-H(P1-022H)	2.2	EX50C	10	HS8	HS8	EX50C	10	HS8	HS8
P1-00126-H(P1-037H)	3.7	EXK50-C	15	HS8	HS10	EX50C	10	HS8	HS10
P1-00175-H(P1-055H)	5.5	EXK50-C	20	HS8	HS20	EXK50-C	15	HS8	HS20
P1-00250-H(P1-075H)	7.5	EXK50-C	30	HS8	HS25	EXK50-C	20	HS20	HS25
P1-00310-H(P1-110H)	11	EXK50-C	40	HS20	HS35	EXK50-C	30	HS25	HS35
P1-00400-H(P1-150H)	15	EXK50-C	50	HS25	HS50	EXK50-C	40	HS35	HS50
P1-00470-H(P1-185H)	18.5	EXK100-C	75	HS35	HS50	EXK50-C	50	HS50	HS50
P1-00620-H(P1-220H)	22	EXK100-C	75	HS50	H65C	EXK60-C	60	HS50	H65C
P1-00770-H(P1-300H)	30	EXK100-C	100	HS50	H80C	EXK100-C	75	H80C	H80C
P1-00930-H(P1-370H)	37	RXX125-S	125	H80C	H100C	EXK100-C	100	H80C	H100C
P1-01160-H(P1-450H)	45	EXK225	150	H80C	H125C	RXX125-S	125	H100C	H125C
P1-01470-H(P1-550H)	55	EXK225	200	H100C	H125C	EXK225	150	H150C	H125C
P1-01760-H(P1-750H)	75	RXX250-S	250	H150C	H200C	EXK225	200	H200C	H200C
P1-02130-H(P1-900H)	90	EX400	300	H200C	H250C	EXK225	225	H200C	H250C
P1-02520-H(P1-1100H)	110	EX400	400	H200C	H300C	EX400	300	H250C	H300C
P1-03160-H(P1-1320H)	132	EX600B	500	H250C	H300C	EX400	350	H400C	H400C

- For LD/VLD rating

Model P1-***** (P1-****)	Applicable Motor (kW)	Applicable devices (Input Voltage 400~440V)							
		Without reactor (DCL or ACL)				With reactor (DCL or ACL)			
		Earth-leakage breaker (ELB)		Magnetic Contactor (MC)		Earth-leakage breaker (ELB)		Magnetic Contactor (MC)	
		Example model	Current Rate	AC-1	AC-3	Example model	Current Rate	AC-1	AC-3
P1-00041-H(P1-007H)	1.5	EX50C	10	HS8	HS8	EX50C	5	HS8	HS8
P1-00054-H(P1-015H)	2.2	EX50C	10	HS8	HS8	EX50C	10	HS8	HS8
P1-00083-H(P1-022H)	3.7	EXK50-C	15	HS8	HS10	EX50C	10	HS8	HS8
P1-00126-H(P1-037H)	5.5	EXK50-C	20	HS8	HS20	EXK50-C	15	HS8	HS20
P1-00175-H(P1-055H)	7.5	EXK50-C	30	HS8	HS25	EXK50-C	20	HS8	HS20
P1-00250-H(P1-075H)	11	EXK50-C	40	HS20	HS35	EXK50-C	30	HS8	HS25
P1-00310-H(P1-110H)	15	EXK50-C	50	HS25	HS50	EXK50-C	40	HS20	HS35
P1-00400-H(P1-150H)	18.5	EXK100-C	75	HS35	HS50	EXK50-C	50	HS20	HS35
P1-00470-H(P1-185H)	22	EXK100-C	75	HS50	H65C	EXK60-C	60	HS35	HS50
P1-00620-H(P1-220H)	30	EXK100-C	100	HS50	H80C	EXK100-C	75	HS50	H65C
P1-00770-H(P1-300H)	37	RXX125-S	125	H80C	H100C	EXK100-C	100	HS50	H65C
P1-00930-H(P1-370H)	45	EXK225	150	H80C	H125C	RXX125-S	125	H65C	H80C
P1-01160-H(P1-450H)	55	EXK225	200	H100C	H125C	EXK225	150	H80C	H100C
P1-01470-H(P1-550H)	75	EX400	250	H150C	H200C	EXK225	200	H100C	H125C
P1-01760-H(P1-750H)	90	EX400	300	H200C	H250C	EXK225	225	H125C	H150C
P1-02130-H(P1-900H)	110	EX400	400	H200C	H300C	EX400	300	H150C	H250C
P1-02520-H(P1-1100H)	132	EX600B	500	H250C	H300C	EX400	350	H200C	H250C
P1-03160-H(P1-1320H)	160	EX600B	600	H400C	H400C	EX400	400	H250C	H300C

- ◇ Device model name on above table shows example selection. The device selection should be made in base on rated current, short circuit current capability and accordance to the local electrical legislation.
- ◇ Applicable motor capacity is based on Hitachi 400Vac, 60Hz, 4 pole IE3 motor.
- ◇ Refer to the wire gauge table on chapter 2-8.
- ◇ Electrical endurance for AC-1 magnetic contactor is 500000 times, however, for emergency stop in motor operation will be only 25 times.
- ◇ Select AC-3 class magnetic contactor for inverter output for application which has an emergency stop or commercial power line operation.
- ◇ When selecting oversize inverter capacity compare to motor rating, select according to the inverter capacity

## 2.8 Chopper Braking Resistor

- SJ Series P1 has a built-in chopper braking circuit in model below.  
P1-00044-L (004L) to P1-01240-L (022L)  
P1-00041-H (007H) to P1-00930-H (370H)
- By using an optional braking resistor, permit to use for high regeneration load application such as lift or high speed load.

- SJ Series P1 can offer when desired a built-in chopper braking circuit in models below.  
P1-01160-H (450H) to P1-01470-H (550H)
- Using optional braking unit or regenerative unit, permit to use on high regenerative load application even for models without built-in chopper braking circuit.
- The table below shows an example selection of braking resistor to output 100% of braking torque for each motor rating on list.

### ■ 200V class

Model P1-***** (P1-****)	Appli cable motor (kW)	Min. Resistor (Ω)	Resistor selection Ex. (Ω)	Braking Resistor			
				Model	Usage ratio (%)	Short period capacity (kW)	Rated capacity (kW)
00044-L (004L)	0.4	50	180	SRB200-1	10	0.7	0.2
00080-L (007L)	0.75	50	100	SRB200-1	10	0.7	0.2
00104-L (015L)	1.5	35	100	SRB200-2	7.5	1.25	0.2
00156-L (022L)	2.2	35	50	SRB300-1	7.5	2.5	0.3
00228-L (037L)	3.7	35	35	SRB400-1	7.5	3.6	0.4
00330-L (055L)	5.5	16	17	RB3	10	7.7	1.2
00460-L (075L)	7.5	10	17	RB3	10	7.7	1.2
00600-L (110L)	11	10	11.7	RB2 ×3 parallel	10	11.4	1.8
00800-L (150L)	15	7.5	8.5	RB3 ×2 parallel	10	15.4	2.4
00930-L (185L)	18.5	7.5	8.5	RB3 ×2 parallel	10	15.4	2.4
01240-L (220L)	22	5	5.7	RB3 ×3 parallel	10	23.1	3.6

◇ When using RB2×2series×2parallel, will require in total 4 RB2 units.

### ■ 400V

Model P1-***** (P1-****)	Appli cable motor (kW)	Min. Resistor (Ω)	Resistor selection Ex. (Ω)	Braking Resistor			
				Model	Usage ratio (%)	Short period capacity (kW)	Rated capacity (kW)
00041-H (007H)	0.75	100	360	SRB200-1 ×2series	10	1.4	0.4
00054-H (015H)	1.5	100	100	SRB200-1 ×2series	10	1.4	0.4
00083-H (022H)	2.2	100	100	SRB200-2 ×2series	7.5	2.5	0.4
00126-H (037H)	3.7	70	100	SRB300-1 ×2 series	7.5	5	0.6
00175-H (055H)	5.5	70	100	SRB300-1 ×2 series	7.5	5	0.6
00250-H (075H)	7.5	35	70	SRB400-1 ×2 series	7.5	7.2	0.8
00310-H (110H)	11	35	50	RB1 ×2 series ×2 parallel	10	10.4	1.6
00400-H (150H)	15	24	35	RB2 ×2 series ×2parallel	10	15.2	2.4
00470-H (185H)	18.5	24	35	RB2 ×2 series ×2parallel	10	15.2	2.4
00620-H (220H)	22	20	25	RB1 ×2 series ×4parallel	10	20.8	3.2
00770-H (300H)	30	15	17	RB3 ×2 series ×2parallel	10	30.8	4.8
00930-H (370H)	37	15	17	RB3 ×2 series ×2parallel	10	30.8	4.8
01160-H (450H)	45	10	10	CA-KB (10Ω5unit)	10	45	17
01800-H (550H)	55	10	10	CA-KB (10Ω5unit)	10	45	17

2.9 Wiring

**!** When J51 connector is removed, charge lamp doesn't indicate R0-T0 status. Please make sure that power is off and care for safety. For own safety, make sure to power off before handling the inverter.

<b>Model P1- ******(P1-*****)</b>
200V class: 00044-L(004L), 00080-L(007L), 00104-L(015L), 00156-L(022L), 00228-L(037L)
400V class: 00041-H(007H), 00054-H(015H), 00083-H(022H), 00126-H(037H)

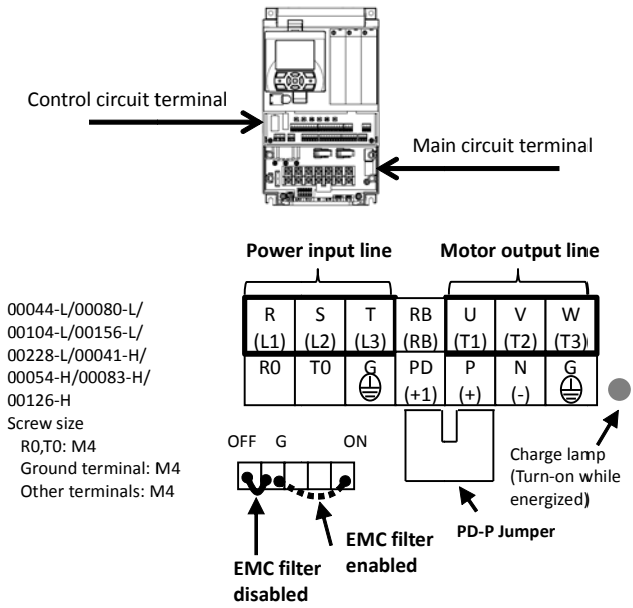

◇ Switch EMC jumper to enable or disable the EMC filter.

<b>Model P1- ******(P1-*****)</b>
200V class: 00330-L(055L), 00460-L(075L), 00600-L(110L)
400V class: 00175-H(055H), 00250-H(075H), 00310-H(110H)

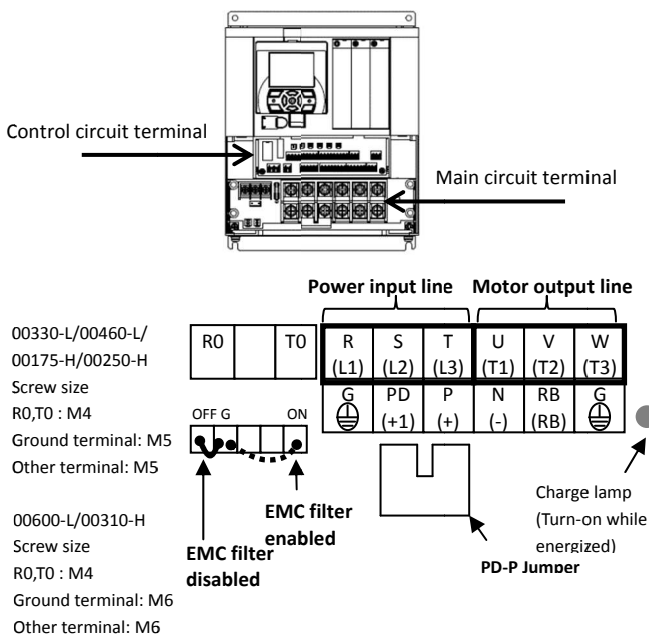

◇ Switch EMC jumper to enable or disable the EMC filter.

<b>Model P1- ******(P1-*****)</b>
200V class: 00800-L(150L)/00930-L(185L)/01240-L(220L)

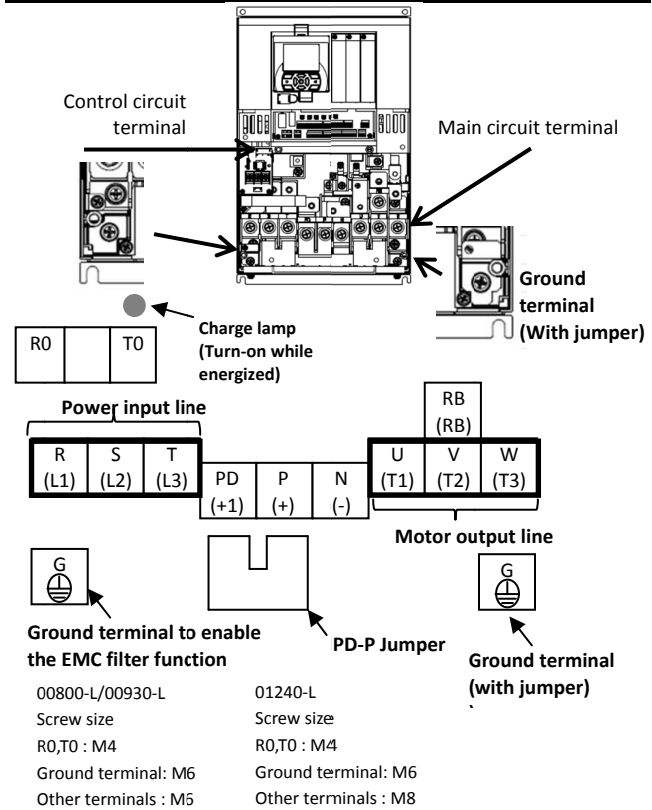

◇ To enable or disable the EMC filter, insert or remove the EMC jumper of the ground terminal.

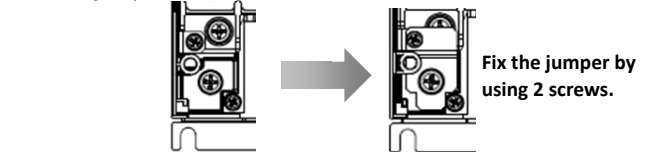

<b>Model P1- ******(P1-*****)</b>
400V class: 00400-H(150H), 00470-H(185H), 00620-H(220H)

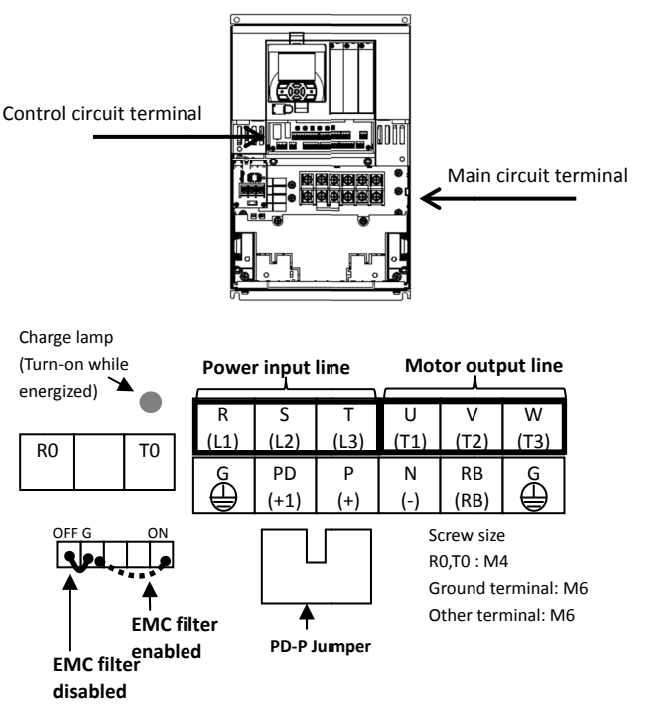

◇ Switching the short-circuit connector can enable/disable the EMC filter.

**Model P1- \*\*\*\*\*\*(P1-\*\*\*\*)**  
 200V class: 01530-L(300L)

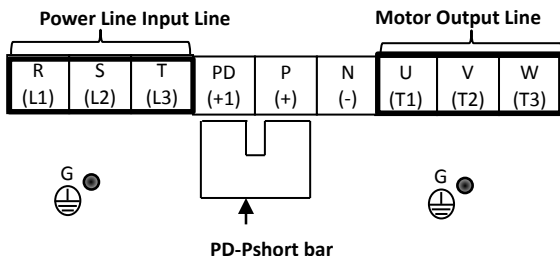
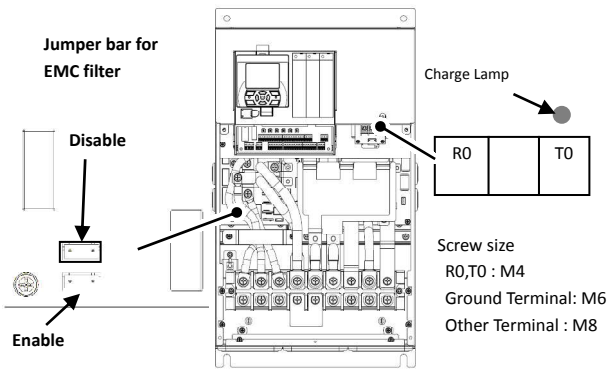

◇ Switch the jumper bar to enable or disable the EMC filter.

**Model P1- \*\*\*\*\*\*(P1-\*\*\*\*)**  
 200V class: 01850-L(370L)

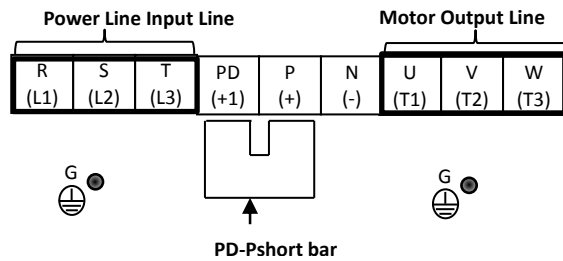
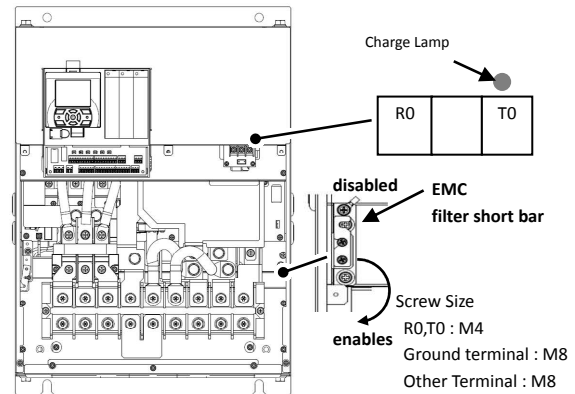

◇ Switch the jumper bar to enable or disable the EMC filter.

**Model P1- \*\*\*\*\*\*(P1-\*\*\*\*)**  
 400V class: 00770-H(300H)

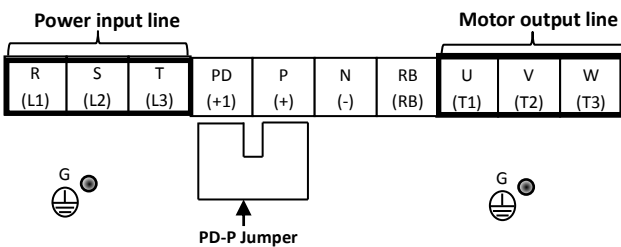
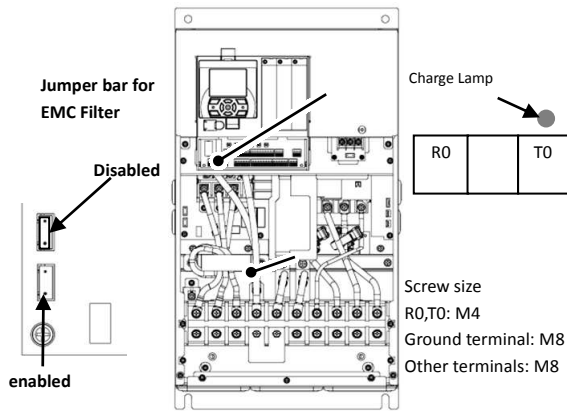

◇ Switch the jumper bar to enable or disable the EMC filter.

**Model P1- \*\*\*\*\*\*(P1-\*\*\*\*)**  
 400V class: 00930-H(370H)

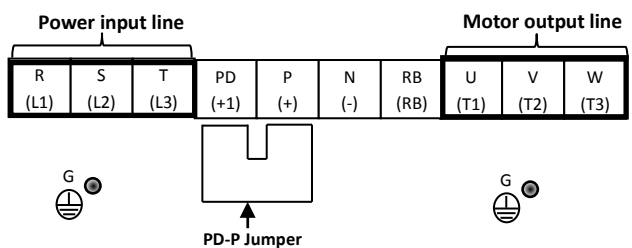
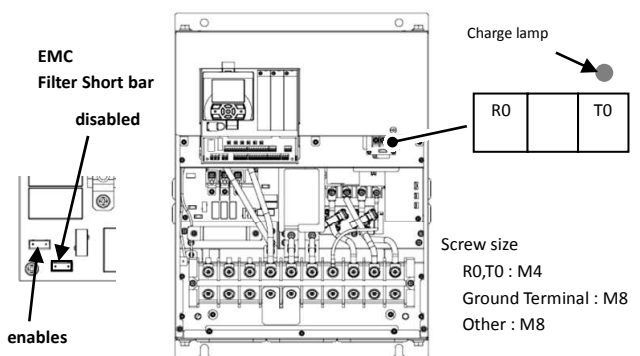

◇ Switch the jumper bar to enable or disable the EMC filter.

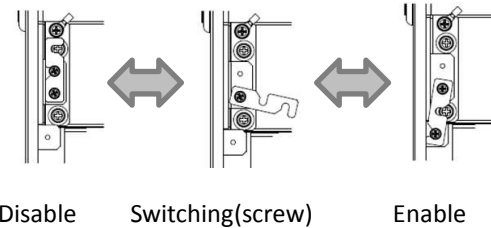

**Model P1- \*\*\*\*\*\*(P1-\*\*\*\*)**  
 200V class: 02290-L(450L)

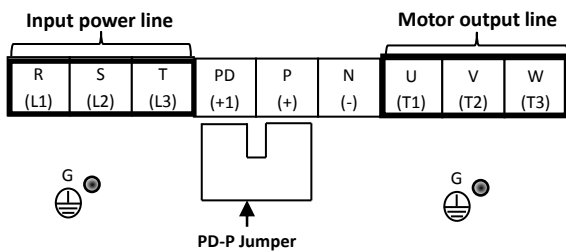
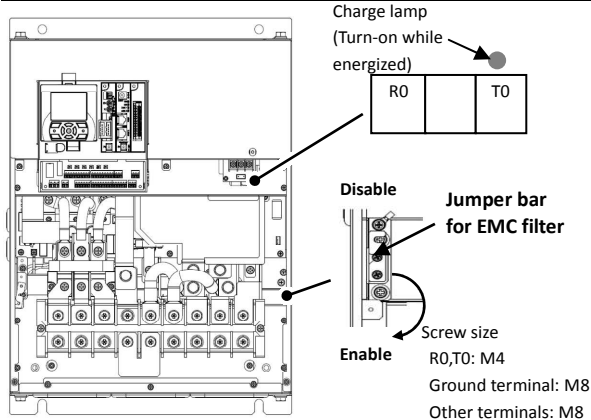

◇ Switch the jumper bar to enable or disable the EMC filter.

**Model P1- \*\*\*\*\*\*(P1-\*\*\*\*)**  
 200V class: 02590-L(550L)

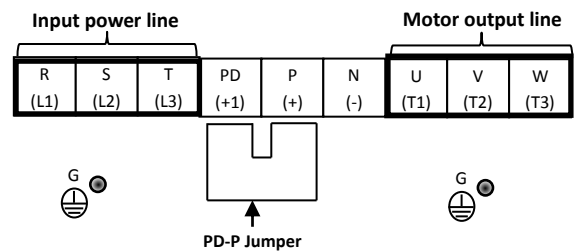
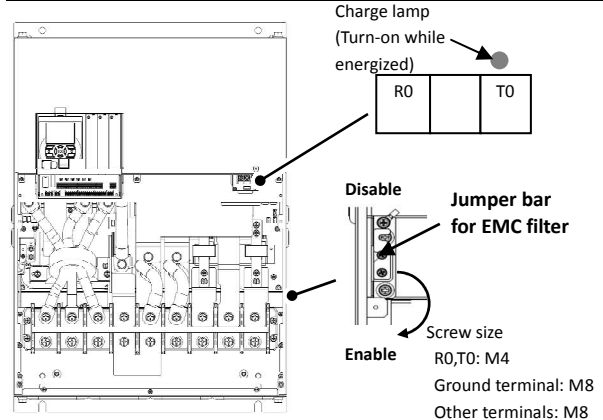

◇ Switch the jumper bar to enable or disable the EMC filter.

**Model P1- \*\*\*\*\*\*(P1-\*\*\*\*)**  
 400V class: 01160-H(450H)

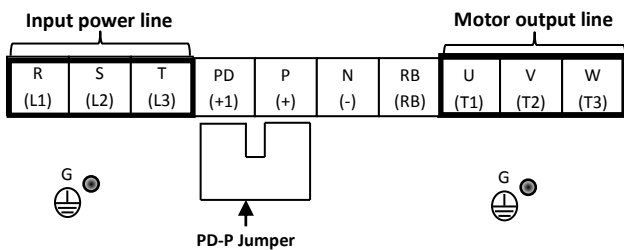
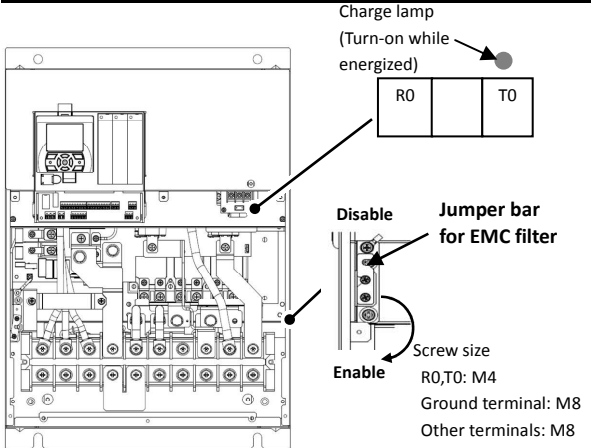

◇ Switch the jumper bar to enable or disable the EMC filter.

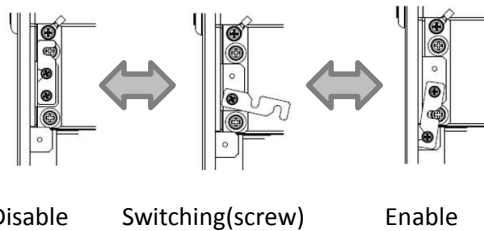

**Model P1- \*\*\*\*\*\*(P1-\*\*\*\*)**  
 400V class: 01470-H(550H)

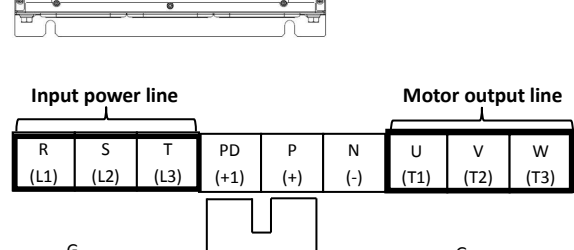
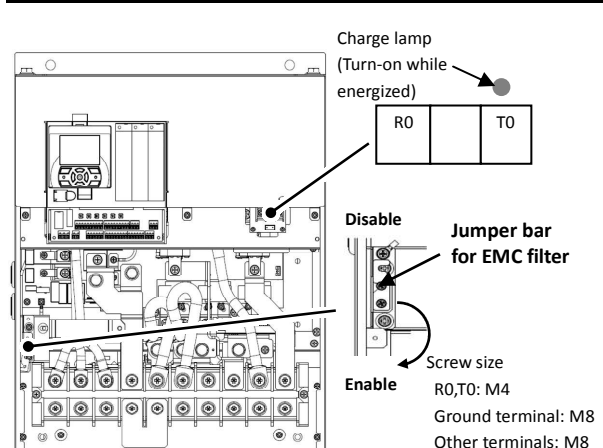

◇ Switch the jumper bar to enable or disable the EMC filter.

<b>Model P1- ******(P1-****)</b>
200V class: 01760-H(750H)

(In preparation)

<b>Model P1- ******(P1-****)</b>
200V class: 02520-H(1100H)

(In preparation)

<b>Model P1- ******(P1-****)</b>
400V class: 02130-H(900H)

(In preparation)

<b>Model P1- ******(P1-****)</b>
400V class: 03160-H(1320H)

(In preparation)

✧



### 2.10 Wiring of the control circuit

◇ An example for sink logic.

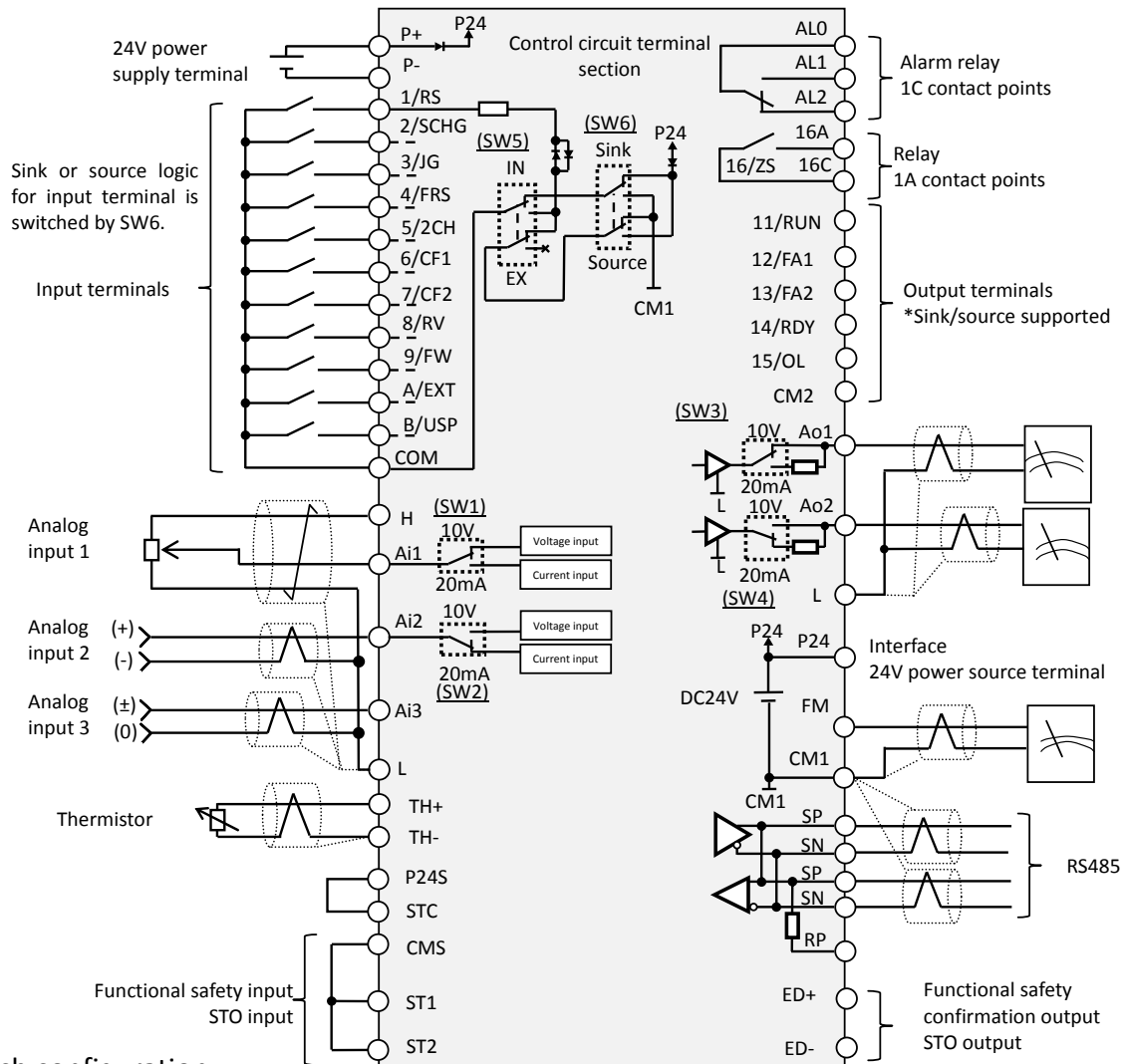

#### Switch configuration

Label	Switch Name	Description
Ai1 (SW1)	Analog input 1 switch	It changes the input specification of Analog input 1 (Ai1 terminal). 10V: Voltage input is available. 20mA: Current input is available.
Ai2 (SW2)	Analog input 2 switch	It changes the input specification of Analog input 2 (Ai2 terminal). 10V: Voltage input is available. 20mA: Current input is available.
Ao1 (SW3)	Analog output 1 switch	It changes the output specification of Analog output 1 (Ao1 terminal). 10V: Voltage output is applied. 20mA: Current output is applied.
Ao2 (SW4)	Analog output 2 switch	It changes the output specification of Analog output 2 (Ao2 terminal). 10V: Voltage output is applied. 20mA: Current output is applied.
P.SEL (SW5)	Power supply input switch	It changes the power source for input terminals. IN: Internal power source. EX: External power source. (While setting EX, it requires an external power supply between input terminals and COM terminal)
SRC/SINK (SW6)	Input terminal Sink/Source logic switching	It changes the sink or source logic for input terminal. Is enabled when SW5 is in IN position. SINK: Switch to Sink logic. SRC: Switch to Source logic.

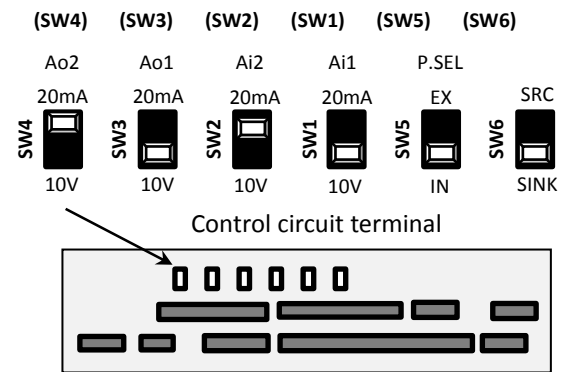

◇ Make sure to power-off previous to change any switches. Otherwise, may damage the inverter.

■ Recommended terminals for wiring

- The following ferrule terminals are recommended for signal cable for easy wiring and improved reliability of connectivity.

Ferrule terminal with sleeves

Power cable size mm <sup>2</sup> (AWG)	Ferrule terminal model*	L1 [mm]	L2 [mm]	φ d [mm]	φ D [mm]	
0.25 (24)	AI 0,25-8YE	8	12.5	0.8	2.0	
0.34 (22)	AI 0,34-8TQ	8	12.5	0.8	2.0	
0.5 (20)	AI 0,5-8WH	8	14	1.1	2.5	
0.75 (18)	AI 0,75-8GY	8	14	1.3	2.8	

\*) Manufacturer: Phoenix Contact

Crimping tool: CRIMPFOX UD 6-4 or CRIMPFOX ZA 3

■ Wiring procedure

1. Push the gray part on the control circuit terminal block into the socket with a slotted screwdriver (with a wide of 2.5mm or less). (Insertion hole will open)
2. Insert the wire or ferrule terminal into the wire insertion hole (round) while pressing the gray part with a slotted screwdriver.
3. The wire is connected when release the screw driver.

- Even for pulling out the wire from the socket, press the gray part with a slotted screwdriver (the insertion hole will be opened while pressing).  
(remark) Actual color of terminal is orange.

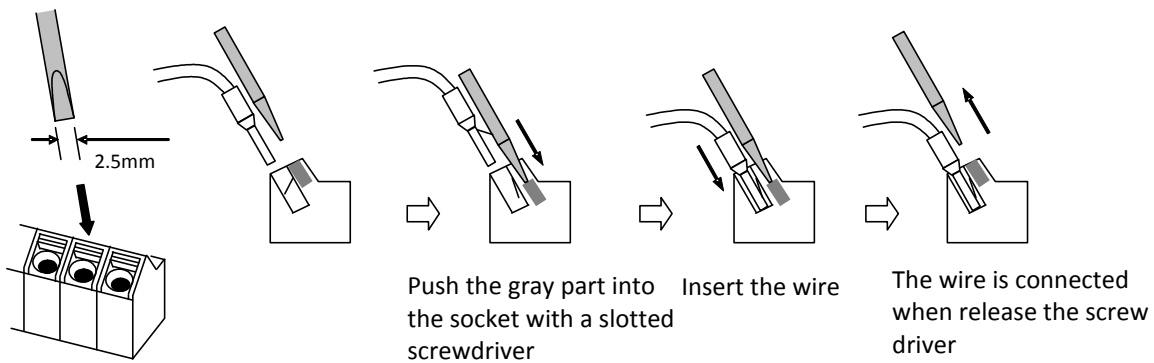

### 2.11 Control circuit wiring section

■ Input terminals

- All COMs have the same electric potential.
- Change SW5 to external power source (EX) to connect the power source between Input terminals 1 to 9, A or B, and COM.
- Sink or source logic of the input terminal is switched by SW6.

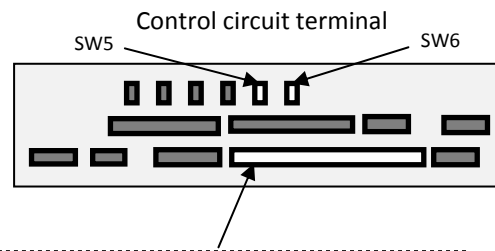

(Wiring example)

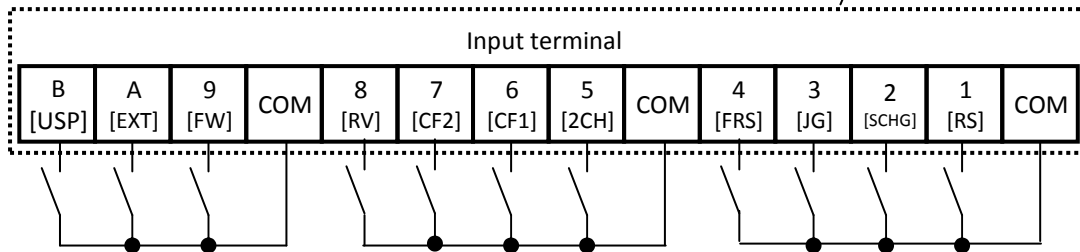

- [ ] it means factory default settings.

			Terminal label	Terminal name	Description	Electric characteristics
Intelligent input terminal	Digital input	Contact	9, 8, 7, 6, 5, 4, 3, 2, 1	Input terminal	Terminal functions are selectable according to the parameter settings for each terminal. Switching SW6 to SRC or SINK allows you to select SINK or Source logic.	Voltage between each input and COM terminals • ON voltage Min.DC18V • OFF voltage Max.DC3V • Max. allowable voltage DC27V • Load current 5.6mA(at DC27V)
		Pulse	A	Pulse input-A	This is a terminal for pulse input. A and B terminals can be used also as an input terminal. Terminal functions are selectable according to the parameter settings for each terminal. The maximum input pulse rate is 32kpps.	Voltage between an input and COM terminals • ON voltage Min.DC18V • OFF voltage Max.DC3V • Max. allowable voltage DC27V • Load current 5.6mA(at DC27V) • Max input pulse rate 32kpps
	Common	COM	Input (common)	This is a common terminal for digital input terminals (1,2,3,4,5,6,7,8,9,A and B). Three COM terminals are available.		

■ Terminal's default function ([symbol: setting No.]

[RS:028]Reset

- Reset at every trip.

[SCHG:015]Command source change

- Change to the main speed command [AA101](OFF) or sub-speed command[AA102](ON).

[JG:029]Jogging

- Run at a frequency of [AG-20] upon receipt of the operation command by [JG]ON.

[FRS:032]Free-run stop

- [FRS]ON sets the motor in a free-run state.

[2CH:031]Two-step acceleration/deceleration

- [2CH]ON enables acceleration/deceleration time-2[AC124][AC126].

[EXT:033]External trip

- [EXT]ON issues Trip[Er012].

[FW:001]Forward rotation and [RV:002]Reverse rotation

Forward	Reverse	Description
OFF	OFF	No command
ON	OFF	Forward rotation command operation
OFF	ON	Reverse rotation command operation
ON	ON	No command (inconsistent logic)

[CF1:003]Multispeed-1 and [CF2:004]Multispeed-2 commands

Multispeed-1 CF1	Multispeed-2 CF2	Description
OFF	OFF	The set frequency source is enabled.
ON	OFF	The frequency source of [Ab-11] is enabled.
OFF	ON	The frequency source of [Ab-12] is enabled.
ON	ON	The frequency source of [Ab-13] is enabled.

\*) Setting CF3 and 4 allows you to set up to 16-speed.

[USP:034]Unattended start protection

- In a [USP]ON state, if an operation command has been input before the power supply is ON, Trip[Er013] is issued.

■ Output terminals  
(Wiring example)

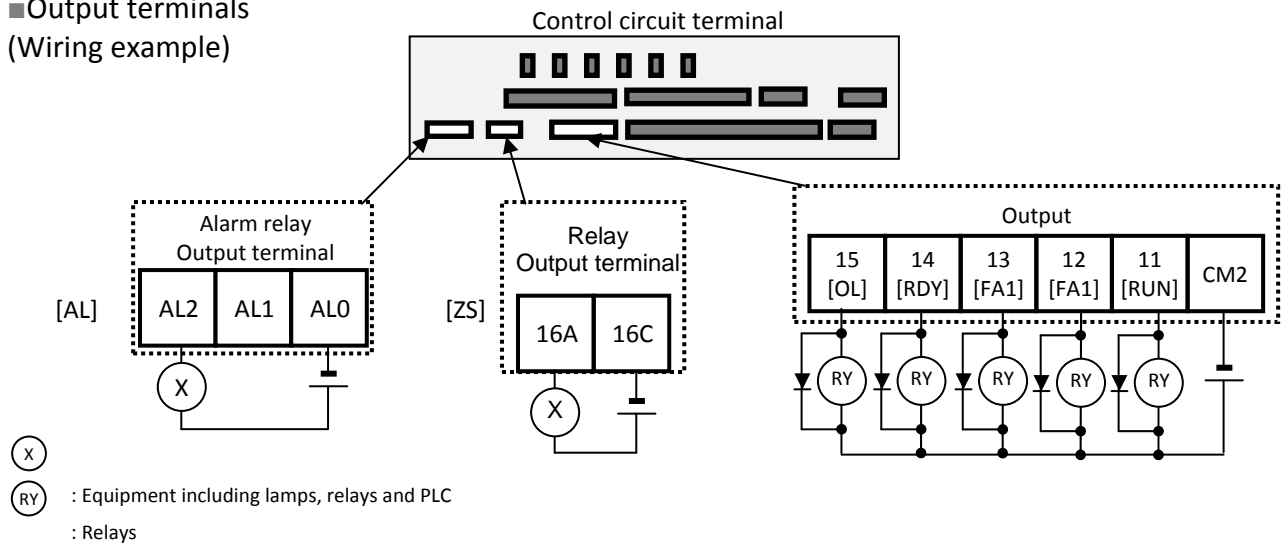

• [ ] it means factory default settings.

[AL:017]Operation

		Terminal label	Terminal name	Description	Electric characteristics
Intelligent output terminals	Open collector	15 14 13 12 11	Output terminal	Terminal functions are selectable according to the parameter settings for each terminal. This is available for both SINK and Source logics.	Open collector output Between each terminal and CM2 • Voltage drop when turned on: 4 V or less • Max. allowable voltage 27V • Max. allowable current 50mA
		CM2	Output (common)	This is a common terminal for output terminals 11 to 15.	
		16A 16C	1a relay terminal	Relays for A contact output	Maximum contact capacity • AC250V, 2A(resistance) • AC250V, 1A(inductive load) (Minimum contact capacity) • DC1V, 1mA
	Relay	AL0 AL1 AL2	1c relay terminal	Relays for C contact output	Maximum contact capacity AL1/AL0: • AC250V, 2A(resistance) • AC250V, 0.2A(inductive load) AL2/AL0: • AC250V, 1A(resistance) • AC250V, 0.2A(inductive load) Minimum contact capacity (common) • AC100V, 10mA • DC5V, 100mA

■ Terminal's default function

[RUN:001]Running signal

- Turns ON during operation (PWM output).

[FA1:002]Frequency-arrival signal

- Turns ON when the output frequency reaches the control frequency.

[FA1:003]Frequency-arrival signal 2

- Turns ON when the output frequency reaches the control frequency [CE-10] to [CE-13].

[IRDY:007]

- Turns ON when is ready for operation.

[OL:035]Overload notice advance signal

- Turns ON when the current exceeds the overload warning level.

[ZS:040]0Hz speed detection signal

- Turns ON when the inverter output frequency falls below the threshold frequency [CE-33].

• In case of [CC-17]=00 (factory setting)

Power supply	Status	AL0-AL1	AL0-AL2
ON	Normal operation	Open	Closed
ON	Tripping	Closed	Open
OFF	–	Open	Closed

• In case of [CC-17]=01

Power supply	Status	AL0-AL1	AL0-AL2
ON	Normal operation	Closed	Open
ON	Tripping	Open	Closed
OFF	–	Open	Closed

■ Analog input/output  
(Wiring example)

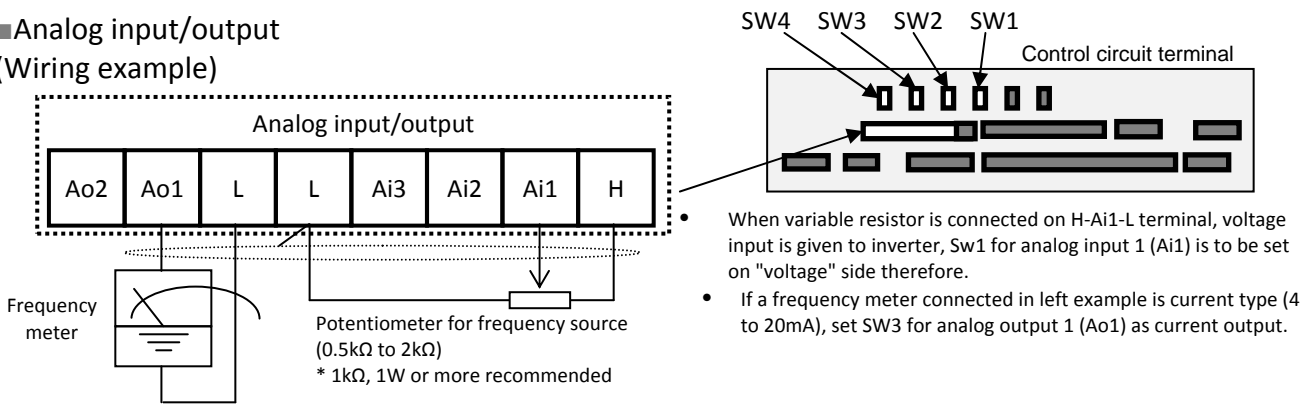

		Terminal label	Terminal name	Description	Electric characteristics
Voltage/current switchable analog input/output terminal	Power supply	L	COM for analog power supply	COM terminals for analog input terminals (Ai1,Ai2,Ai3) and analog output terminals (Ao1,Ao2). Two L terminals are available.	
		H	Speed setting power supply	DC10V power supply. Used for voltage input with analog input terminals (Ai1,Ai2,Ai3) using a variable resistor.	Max. allowable input current 20mA
	Analog input	Ai1	Analog input terminal 1 (Voltage/current selector SW1)	Either Ai1 or Ai2 can be used by switching the selector switch to DC0 to 10V voltage input or 0- to 20mA current input. Used as speed input and feedback input.	For voltage input:
		Ai2	Analog input terminal 2 (Voltage/current selector SW2)		<ul style="list-style-type: none"> <li>Input impedance Approx.10kΩ</li> <li>Allowable input voltage DC-0.3V to 12V</li> </ul>
		Ai3	Analog input terminal 3	DC-10 to 10V voltage input is available. Used as speed input and feedback input.	For current input:
	Analog output	Ao1	Analog output terminal 1 (Voltage/current selector SW3)	Either Ao1 or Ao2 can be used as an output for inverter monitoring data by switching the selector switch to DC0 to 10V voltage output or 0 to 20mA current output.	<ul style="list-style-type: none"> <li>Input impedance Approx.100Ω</li> <li>Max. allowable input current 24mA</li> </ul>
Ao2		Analog output terminal 2 (Voltage/current selector SW4)	<ul style="list-style-type: none"> <li>Max. allowable output current 2mA</li> <li>Output voltage accuracy ±10% (Ambient temperature: 25±10 degrees C)</li> </ul>		
					Voltage input only: <ul style="list-style-type: none"> <li>Input impedance Approx.10kΩ</li> <li>Allowable voltage input DC-12V to 12V</li> </ul>
					For current input: <ul style="list-style-type: none"> <li>Allowable load impedance 250Ω or less</li> <li>Output current accuracy ±20% (Ambient temperature: 25±10 degrees C)</li> </ul>

■ External thermistor  
(Wiring example)

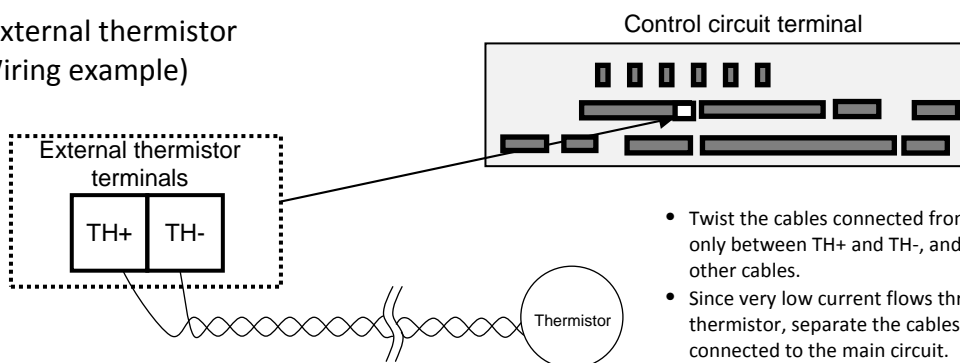

- Twist the cables connected from a thermistor to the TH terminal only between TH+ and TH-, and separate the twisted cables from other cables.
- Since very low current flows through the cables connected to the thermistor, separate the cables from those (power line cables) connected to the main circuit.
- The length of the cables connected to the thermistor must be 20 m or less.

		Terminal label	Terminal name	Description	Electric characteristics
Thermistor terminal	Analog input	TH+	External thermistor input	Connect to an external thermistor to make the inverter trip if an abnormal temperature is detected. Connect the thermistor to TH+ and TH-. The impedance to detect temperature errors can be adjusted within the range 0Ω to 9,999Ω. [Recommended thermistor properties] Allowable rated power: 100 mW or more Impedance at temperature error: 3kΩ	DC0 to 5V [Input circuit]
		TH-	Common terminal for external thermistor input		

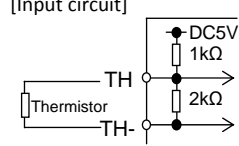

■ Functional safety STO terminals

◇ This function is in preparation.

Terminal label	Terminal name	Description
P24S	24V output power source terminal	In preparation
CMS	COM terminal for functional safety	
STC	Logic switching terminal	
ST1	STO input1	
ST2	STO input2	
ED+	Output terminal for monitoring	
ED-	Output COM terminal for monitoring	

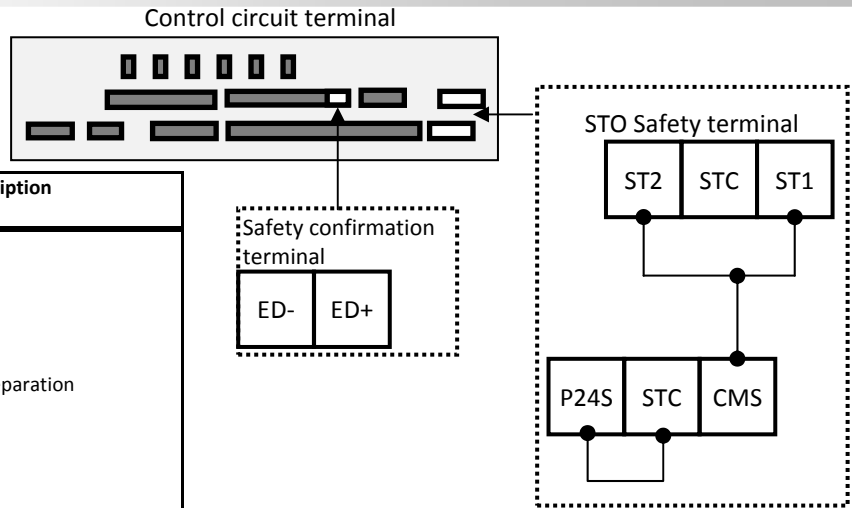

■ FM output terminals  
(Wiring example)

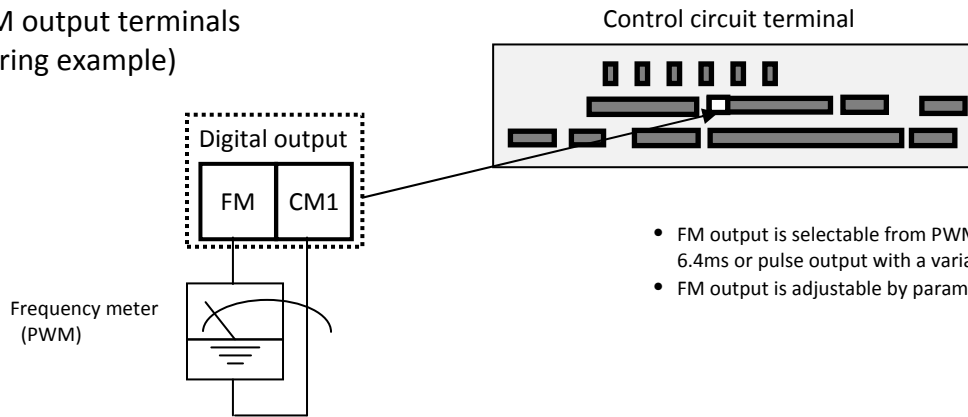

- FM output is selectable from PWM output with a fixed cycle of 6.4ms or pulse output with a variable cycle.
- FM output is adjustable by parameter settings.

			Terminal label	Terminal name	Description	Electric characteristics
FM output terminal	FM output	Monitor output	FM	Digital monitor (voltage)	Digital monitor output is selectable from PWM output with 6.4ms cycle or pulse output with a variable duty cycle of approx. 50%.	Pulse train output DC0 to 10V • Max. allowable output current 1.2mA • Maximum frequency 3.60kHz
			CM1	COM for digital monitor	This is a common terminal for digital monitor. This is also used as 0V reference potential for P24.	

■ Serial communication  
(Wiring example)

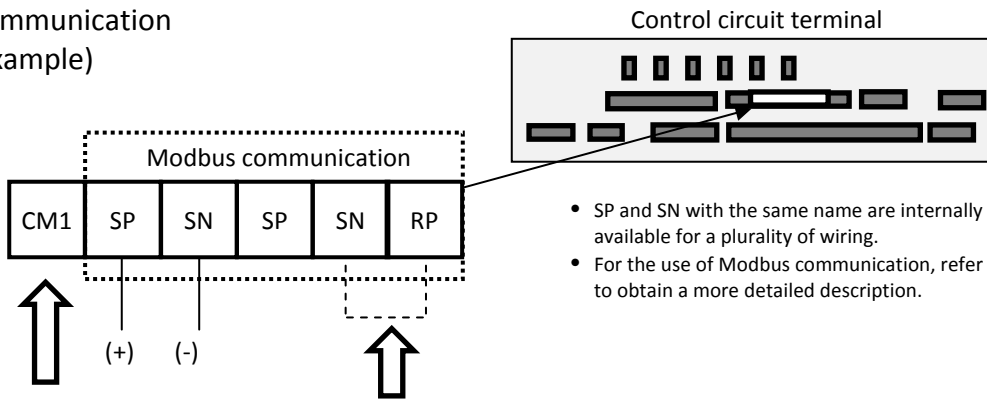

- SP and SN with the same name are internally connected, which are available for a plurality of wiring.
- For the use of Modbus communication, refer to the “User’s guide” to obtain a more detailed description.

Connect CM1  
Into the SG (signal ground) of  
external devices,

For enabling the termination  
resistor, short-circuit between  
RP and SN.

	Terminal label	Terminal name	Description	Electric characteristics
RS485 communication	Serial communication	SP	SP terminal: RS-485 differential(+) signal	Termination resistor (120Ω) integrated Enabled: RP-SN shorted Disabled: RP-SN opened
		SN	SN terminal: RS-485 differential(-) signal	
RP	RP terminal: Connect to SP through a termination resistor			
(CM1)	CM1 terminal: Connect to the signal ground of external communication devices.			
		MODBUS terminal (RS-485)	There are two SP and two SN terminals, which are connected internally. The maximum baud rate is 115.2kbps.	

■ 24V power supply input/output  
(Wiring example)

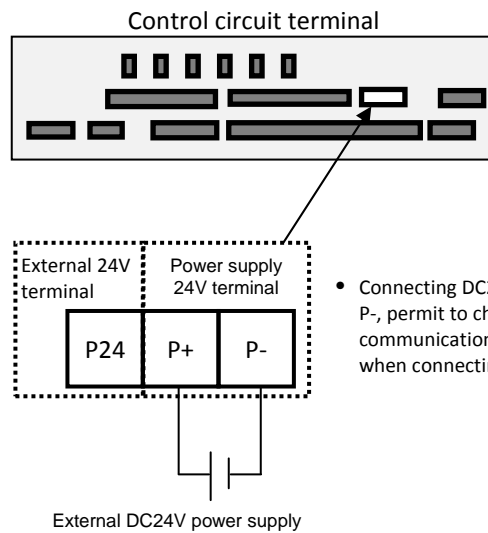

- Connecting DC24V external power supply into the terminal P+ and P-, permit to change parameters and perform optional communication without the main power source. Is also allowable when connecting into the main power supply.

	Terminal label	Terminal name	Description	Electric characteristics	
24V power supply	Power input	P24	24V output power source terminal	This terminal supplies DC24V power for contact signals.	Max. output 100mA
		CM1	Reference terminal for 24V output	This serves as a 0V reference terminal for contact signal. This is used also as a common terminal for FM output.	
		P+	Terminal for external 24V input (24V)	Input external DC24V power supply to the inverter. 24V power supply input permit to change parameter settings and perform optional communication operations without control power supply.	Allowable input voltage DC24V±10% Max. allowable current 1A
		P-	Terminal for external 24V input (0V)		

### 2.12 Residual risk

#### Parts subject to residual risk

Please check for any residual risk upon completion of the installation before power on.

#### Residual risk checklist No.

No.	Name of part	DANGER	WARNING	CAUTION
(A)	Main circuit terminal block	8,10		
(B)	Heat sink	4		1
(C)	Input/output terminal block	11,13		
-	Unspecified parts	9,12,14		2,3,5,6,7

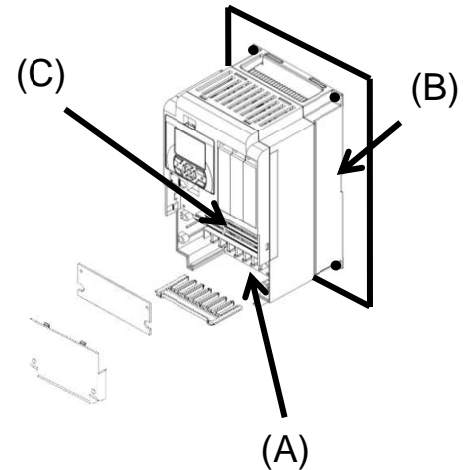

#### Residual risk checklist

No.	Operational phase	Work	Part	Residual risk	Details of harm or damage	Preventive measures	✓
1	Installation	Installation	(B)	CAUTION	Damage due to rough transportation.	Do not let the product fall. Do not apply force when handing the cover and operator keypad.	<input type="checkbox"/>
2	Installation	Installation	-	CAUTION	Shortened lifetime of parts due to the use in places where the product is exposed to direct sunlight or the temperature is not within the specified range.	Verify that the ambient temperature is within the specified range throughout the year by means of cooling or ventilation.	<input type="checkbox"/>
3	Installation	Installation	-	CAUTION	Short-circuit failure due to the use in places where the temperature is not within the specified range or condensation occurs.	Verify that the ambient temperature is within the specified range throughout the year by means of cooling or ventilation. Install the product in places where no condensation occurs.	<input type="checkbox"/>
4	Installation	Installation	(B)	DANGER	A cooling fan reaching a high temperature exceeding 150 °C causes a fire on a flammable wall.	Install the product on a non-flammable metal wall.	<input type="checkbox"/>
5	Installation	Installation	-	CAUTION	Damage to parts due to entry of dust and corrosive gases.	Install the product inside a totally enclosed panel.	<input type="checkbox"/>
6	Installation	Installation	-	CAUTION	Shortened lifetime of parts due to reduced cooling capability by placing the product horizontally.	Install the product vertically.	<input type="checkbox"/>
7	Installation	Installation	-	CAUTION	A cooling fan failed due to waterdrops or oil mist when the heat sink is positioned outside.	With the heat sink positioned outside, install the product in places free from waterdrops and oil mist.	<input type="checkbox"/>
8	Installation Maintenance	Wiring	(A)	DANGER	A fire is caused inside by an arc due to screws loosened by vibrations.	Regularly check the tightening of screws.	<input type="checkbox"/>
9	Installation Maintenance	Wiring	-	DANGER	A fire from flammable materials caused by an arc due to screws loosened by vibrations.	Regularly check the tightening of screws. Do not place flammable materials near the product.	<input type="checkbox"/>
10	Use Maintenance	Wiring Inspection	(A)	DANGER	Electric shock by touching a high voltage part with the cover removed.	Do not open the cover when the power is on. Wait for 10 minutes or more after the power is off, and then confirm that the voltage between P and N is significantly less than 45Vdc to start the work.	<input type="checkbox"/>
11	Use Maintenance	Wiring Inspection	(C)	DANGER	Electric shock by touching a high voltage part with a tool with the cover removed.	Do not open the cover when the power is on. Wait for 10 minutes or more after the power is off, and then confirm that the voltage between P and N is significantly less than 45Vdc to start the work.	<input type="checkbox"/>

✧ The installation, wiring and setting work must be conducted by qualified engineers.



No.	Operational phase	Work	Part	Residual risk	Details of harm or damage	Preventive measures	✓
12 (a)	Installation	Wiring	-	DANGER	Motor insulation damage due to surge caused by long distance motor wiring.	When the motor wiring distance exceeds 20m or more, try to shorten the wiring. Use LCR filter or output AC reactor.	<input type="checkbox"/>
12 (b)	Installation	Wiring	-	DANGER	Motor damage due to insulation failure caused by motor voltage unmatched.	Use motor according to the inverter voltage class.	<input type="checkbox"/>
12 (c)	Installation	Wiring	-	DANGER	Motor damage due to unstable power supply, caused by power supply unbalance, low voltage or excessive voltage drop.	Confirm the inverter power supply voltage, feeding method and capacity.	<input type="checkbox"/>
12 (d)	Use Maintenance	Wiring Inspection	-	DANGER	Motor damage due to continue ran in open phase on motor output line.	Verify the motor output line that not being in open phase.	<input type="checkbox"/>
12 (e)	Use Maintenance	Setting	-	DANGER	Motor damage due high current on motor caused by inadequate parameter setting.	Set adequate value for related function parameter of motor electronic thermal level [bC-01] to [bC125]. Set adequate value for base frequency, motor rated current, control mode, motor constant, load rating, direct current output related parameters. (representative parameter) Motor related parameter: IM: [Hb102] to [Hb118] SM(PMM): [Hd102] to [Hd118] Control mode: [AA121] Load rating: [Ub-03] DC braking: [AF101] to [AF109]	<input type="checkbox"/>
13	Use	Operation	(C)	DANGER	The motor once stopped runs automatically.	If automatic restart after motor stop is set by a function, make sure to clearly describe that in the system.	<input type="checkbox"/>
14	General	General	-	DANGER	Damage or injury occurrence from a hidden risk.	Confirm that system is structured for fail safe considering a risk assessment.	<input type="checkbox"/>
15	General	General			Damage or injury occurrence by missing acquisition of information related to risk	Obtain the latest version of user's guide to make those information available. Inform users appropriately.	<input type="checkbox"/>

✧ The installation, wiring and setting work must be conducted by qualified engineers.

✧ For using [SET] function of input terminal, similarly, set the related 2<sup>nd</sup> parameters settings.

(Memo)

# Chapter 3

## Operation Setting and Examples of I/O Adjustment

This chapter describes basic settings, frequency source required for operation, examples of run command source settings and examples of adjusted I/O terminals.

■ Basic settings 1

### 3.1 Set the load rating

- Select [Ub-03] load specification selection on the parameter setting screen.

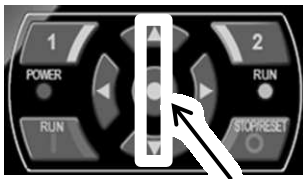
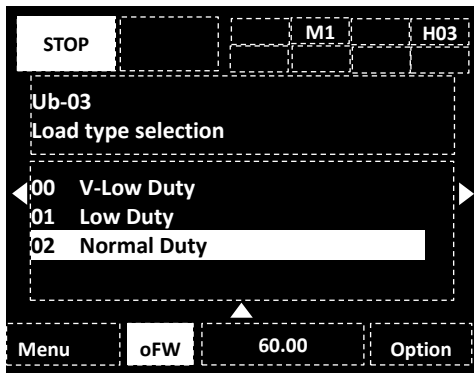

- When [Ub-03] is changed, the parameters set for the current are automatically adjusted in proportion to the changed rated current, and the set values are changed.
- If the current value is set as overload restriction, electronic thermal and warning functions, those are to be reconfirmed after changing this setting. Load specification selection is to be set at first therefore.

■ Parameter

Parameter	Details	Setting data
[Ub-03]	Select the load specification.	00: V-Low Duty (VLD) 01: Low Duty (LD) <u>02: Normal Duty (ND)</u>

\*) The underlined value is set by default.

See "Chapter 4 Settings" for detailed operating instructions

■ Basic settings 2

### 3.2 Set the motor data

- Set the parameters listed in the table below on the parameter setting screen according to the motor you use (e.g. induction motor and permanent-magnet motor).

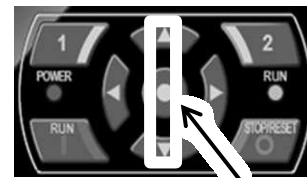
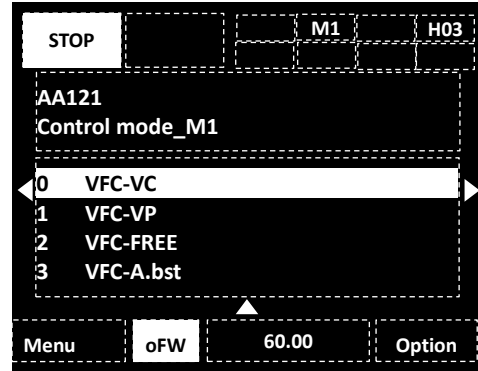

■ Parameter

Induction motor (IM)

Parameter	Details	Setting data
[AA121]	Control pulse setting	00: V/f control constant torque characteristic, etc.
[Hb102]	Capacity selection	0.01 to 160.00 (kW)
[Hb103]	Motor poles setting	2 to 48 (poles)
[Hb104]	Base frequency	10.00 to 590.00 (Hz)
[Hb105]	Maximum frequency	10.00 to 590.00 (Hz)
[Hb106]	Rated voltage	1 to 1000 (V)
[Hb108]	Rated current	0.01 to 9999.99 (A)

Synchronous motor (permanent-magnet motor) (SM(PMM))

Parameter	Details	Setting data
[AA121]	Control pulse setting	11: SM(PMM) Sensorless vector control
[Hd102]	Capacity selection	0.01 to 160.00 (kW)
[Hd103]	Motor poles setting	2 to 48 (poles)
[Hd104]	Base frequency	10.00 to 590.00 (Hz)
[Hd105]	Maximum frequency	10.00 to 590.00 (Hz)
[Hd106]	Rated voltage	1 to 1000 (V)
[Hd108]	Rated current	0.01 to 9999.99 (A)

Note: Motor constant setting is required for driving SM.

The frequency source and run command source are necessary to drive the motor.

■ Frequency source 1

### 3.3 Frequency setting from keypad

- Select [AA101] = 07 Frequency source from parameter setting screen.
- Changing frequency setting from each source
  - (1) [FA-01] for frequency setting from keypad or
  - (2) [Ab110] for frequency setting at multispeed profile.

Eg.) For [FA-01]

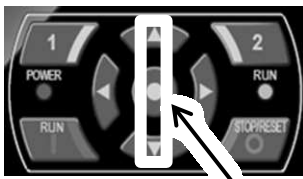
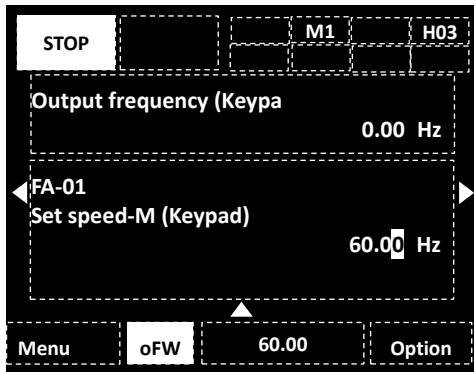

■ Frequency source

- Change the frequency source setting [Ab110] to "Multispeed-0 speed No.1" by using the up and down arrow keys.

■ Parameter

Parameter	Details	Setting data
[AA101]	Frequency source setting from keypad	07
[FA-01]*)	Main speed command	0.00Hz
[Ab110]*)	Multispeed-0 speed No. 1	0.00Hz

\*) While [AA101] = 07, a change made in either [FA-01] or [Ab110] will be automatically reflected in the other. When no change can be made or is reflected in [FA-01], the operator keypad is not specified as a command source by the terminal function or [AA101].

You need to set the frequency value to a value other than 0.00.

■ Run command source 1

### 3.4 Run using the operator keypad

- Select [AA111] = 02 on the parameter setting screen to RUN from keypad.



■ Run/stop command

Press the RUN key and STOP key on the operator keypad to start and stop the inverter, respectively.

■ Parameter

Parameter	Details	Setting data
[AA111]	Run by pressing the RUN key of keypad.	02

■ Frequency source 2

### 3.5 Multispeed terminals command

- While multispeed command is off, the speed command will follow the parameter setting [AA101].
- To use multispeed 0, select [AA101] = 07 frequency source selection.

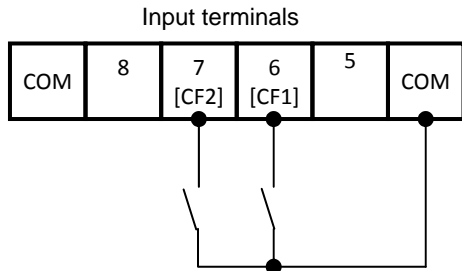

■ Frequency source

- Change the frequency command by turning ON/OFF from multispeed input terminals [CF1] and [CF2].

■ Parameter

Parameter	Details	Setting data
[AA101]	Frequency setting from keypad	07
[FA-01] *1)	Main speed source	0.00Hz
[Ab110] *1)	Multispeed 0 setting 1 <sup>st</sup> motor ([CF1]OFF/[CF2]OFF)	0.00Hz
[Ab-11] *2)	Multispeed 1 setting ([CF1]ON/[CF2]OFF)	0.00Hz
[Ab-12] *2)	Multispeed 2 setting ([CF1]OFF/[CF2]ON)	0.00Hz
[Ab-13] *2)	Multispeed 3 setting ([CF1]ON/[CF2]ON)	0.00Hz
[CA-06]	The terminal 6 for [CF1]	001
[CA-07]	The terminal 7 for [CF2]	002

\*1) While [AA101] = 07, a change made in either [FA-01] or [Ab110] will be automatically reflected in the other. When no change can be made or is reflected in [FA-01], the operator keypad is not specified as a command source by the terminal function or [AA101].

\*2) Set the frequency value for multispeed selection.

■ Run command source 2

### 3.6 Operate using FW/RV terminal

- Select [AA111] = 00 [FW][RV] terminal from parameter setting screen.

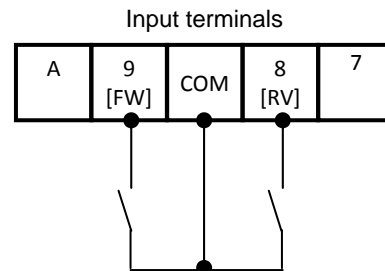

■ Run/stop command

- Run or stop by turning either [FW] terminal or [RV] terminal ON/OFF.

■ Parameter

Parameter	Details	Setting data
[AA111]	Run using FW/RV terminal	00
[CA-09]	The terminal 9 for [FW]	001
[CA-08]	The terminal 8 for [RV]	002

■ Frequency source 3

3.7 Potentiometer frequency command

- Select [AA101] = 01 Ai1 terminal input from parameter setting screen.
- \* Select voltage input (0 to 10V) for Ai1 switch of control circuit board.

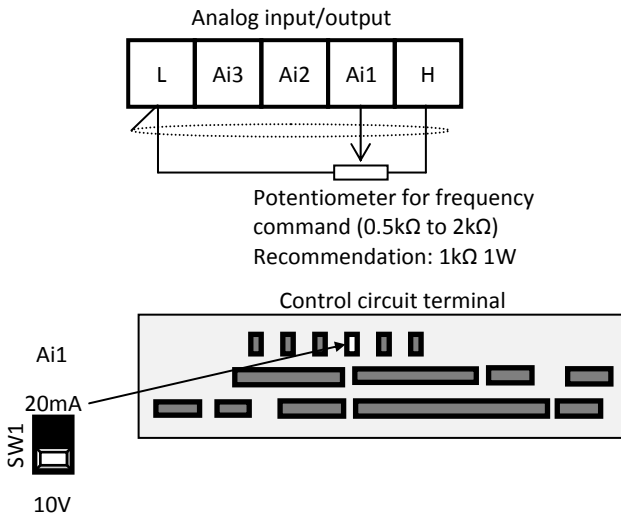

■ Frequency command

- Adjust the position of the knobs on the potentiometer to change the frequency command.

■ Parameter

Parameter	Details	Setting data
[AA101]	Set as frequency command for Ai1 input terminal.	01

■ Run command source 3

3.8 Operate using 3WIRE terminal

- Select [AA111] = 01 to 3WIRE function from parameter setting screen. In this section, 3WIRE functions are assigned into the input terminals.
- \* Terminal 7[CA-07] = 016; terminal 8[CA-08] = 017; terminal 9[CA-09] = 018

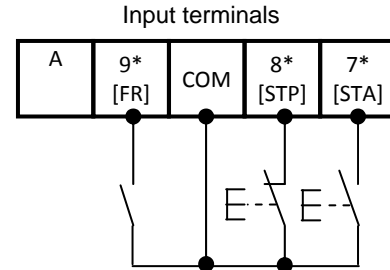

■ Run/stop command

- To run turn ON [STA] terminal, and turn ON [STP] terminal to stop. Select the rotation direction with [FR] terminal.

■ Parameter

Parameter	Details	Setting data
[AA111]	Set the operation command for 3WIRE function.	01
[CA-09]	The terminal 9 is [FR].	018
[CA-08]	The terminal 8 is [STP].	017
[CA-07]	The terminal 7 is [STA].	016

Example for adjusting I/O terminals 1

3.9 Adjust the analog input (Ai1/Ai2)

E.g.) Adjust operation (E.g. for Ai1)

- Set the ratio to input to limit the operating range of the frequency command.  
(When selecting the frequency through terminal input)

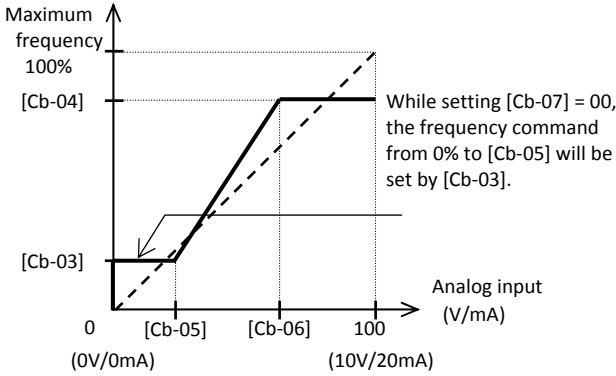

Parameter

Parameter		Details
Ai1	Ai2	
[Cb-03]	[Cb-13]	Set the frequency source ratio to the start ratio of the analog input.
[Cb-04]	[Cb-14]	Set the frequency source ratio to the end ratio of the analog input.
[Cb-05]	[Cb-15]	Set the start ratio of the analog input 0 to 10V/0 to 20mA.
[Cb-06]	[Cb-16]	Set the end ratio of the analog input 0 to 10V/0 to 20mA.

- Ai2 adjustment can be done in similar way to Ai1 by using Ai2 parameters in order to Ai1.

E.g.) Make a fine adjustment (E.g. for Ai1)

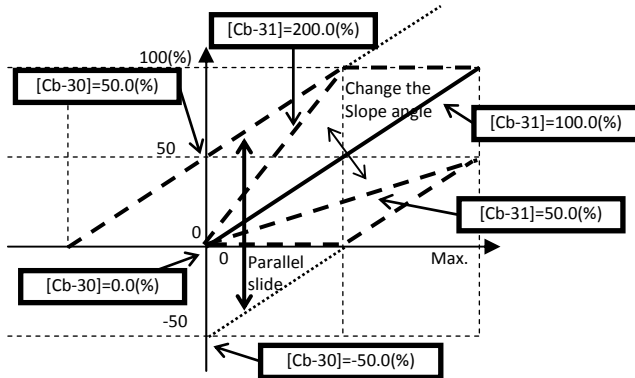

Parameter

Parameter		Details
Ai1	Ai2	
[Cb-30]	[Cb-32]	Adjust the zero-point reference line for voltage input 10V/current input 20mA and the maximum frequency.
[Cb-31]	[Cb-33]	Adjust the slope of the reference line for voltage input 10V/current input 20mA.

\*) Use the switch on control circuit terminal board to change for voltage/current input.

Example for adjusting I/O terminals 2

3.10 Adjust the analog output (Ao1/Ao2/FM)

E.g.) Adjust operation (E.g. for Ao1)

- Set a value equivalent to 0% output first.

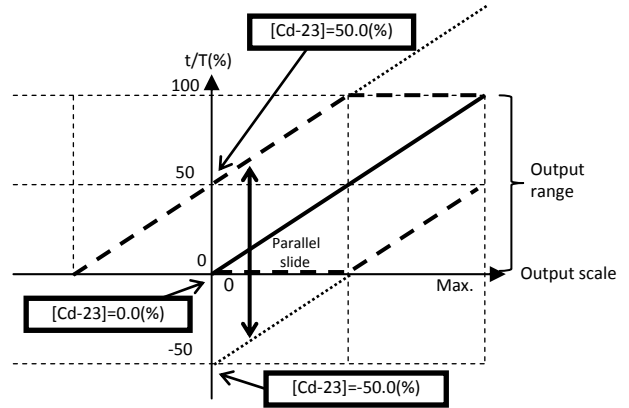

- Then, adjust a value equivalent to 100% output.

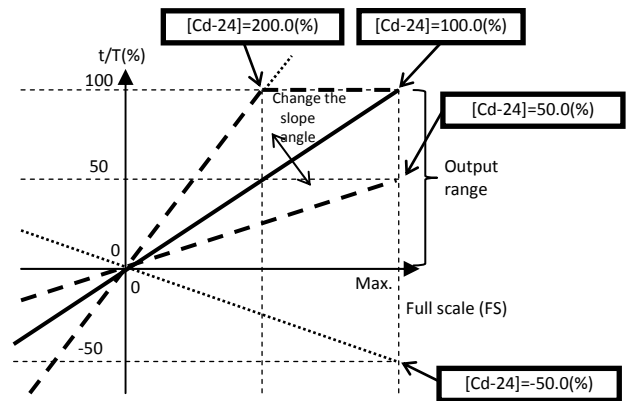

Parameter

Parameter			Details
Ao1	Ao2	FM	
[Cd-23]	[Cd-33]	-	Adjust the zero-point reference line for voltage output 10V/current output 20mA and data at 100%.
[Cd-24]	[Cd-34]	-	Adjust the slope for voltage output 10V/current output 20mA and data at 100%.
-	-	[Cd-13]	Adjust the zero-point reference line for 100% duty cycle output and data at 100%.
-	-	[Cd-14]	Adjust the slope for 100% duty cycle output and data at 100%.

■ Example for adjusting I/O terminals 3

3.11 Adjust the analog input (Ai3)

E.g.) Adjust operation (E.g. for Ai3)

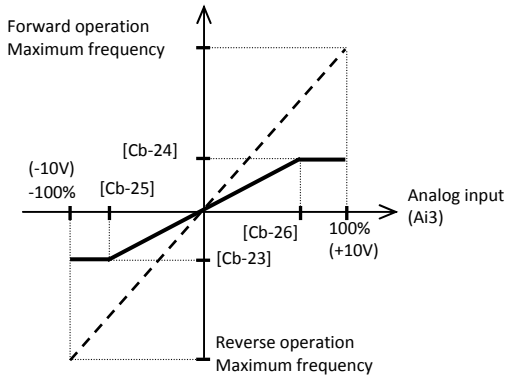

■ Parameter

Parameter	Details
Ai3	
[Cb-23]	Set the frequency source ratio to the start ratio of the analog input.
[Cb-24]	Set the frequency source ratio to the end ratio of the analog input.
[Cb-25]	Set the start ratio of the analog input -10V to 10V.
[Cb-26]	Set the end ratio of the analog input -10V to 10V.

E.g.) Make a fine adjustment

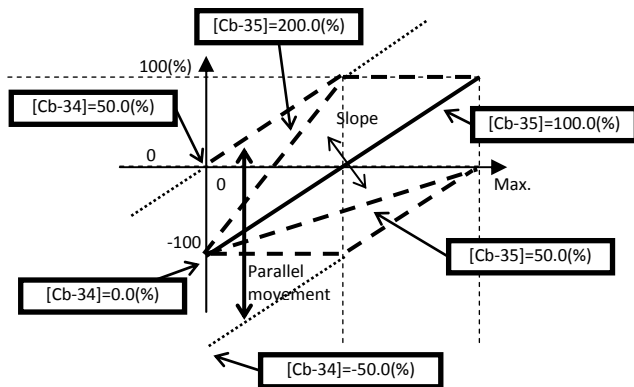

■Parameter

Parameter	Details
Ai3	
[Cb-34]	Adjust -10V on the reference line for -10V/10V and the frequency.
[Cb-35]	Adjust the slope of the reference line.

■ Example for adjusting I/O terminals 4

3.12 Prevent input terminal malfunction

- Set a response time for input terminal to prevent a malfunction due to noise input.

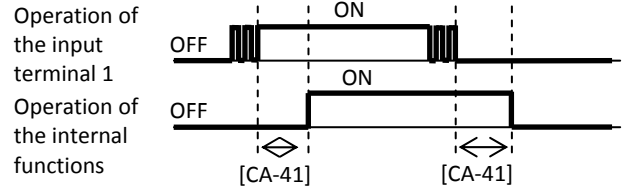

■ Parameter

Input terminal	Response time	Input terminal	Response time
1	[CA-41]	7	[CA-47]
2	[CA-42]	8	[CA-48]
3	[CA-43]	9	[CA-49]
4	[CA-44]	A	[CA-50]
5	[CA-45]	B	[CA-51]
6	[CA-46]		

■ Example of adjusted I/O terminals 5

3.13 Stabilize an output terminal

- Set the delay time to stabilize an output terminal from a sensitive reaction of internal functions.

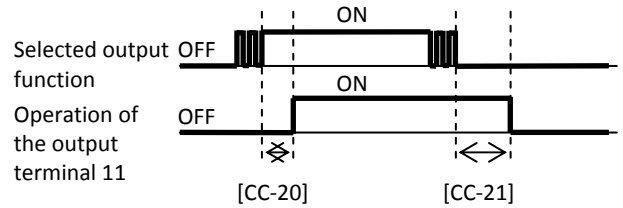

■Parameter

Output terminal	On-delay time	Off-delay time
11	[CC-20]	[CC-21]
12	[CC-22]	[CC-23]
13	[CC-24]	[CC-25]
14	[CC-26]	[CC-27]
15	[CC-28]	[CC-29]
16A-16C	[CC-30]	[CC-31]
AL1-AL0/ AL2-AL0	[CC-32]	[CC-33]



# Chapter 4

## Settings

### 4.1 Keypad overview

#### 4.1.1 How to use the keypad

✧ Image colour may differ from the real product.

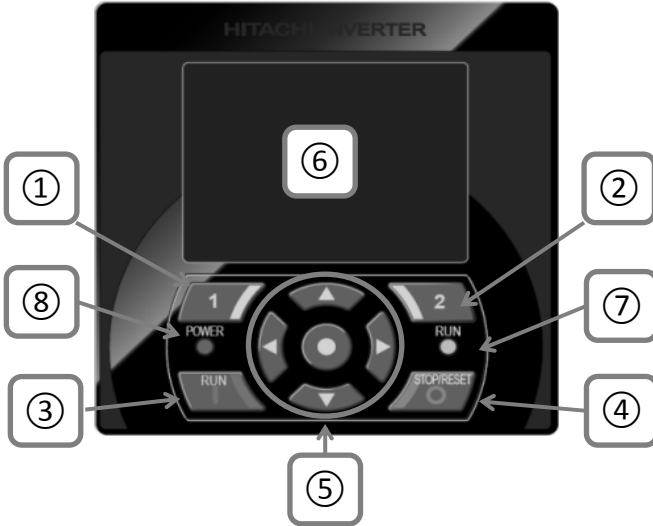

Number	Name	Description
①	F1 key	Transition to home, cancel, etc. Function of the key is indicated at the bottom left of the screen.
②	F2 key	Save data, etc. Function of the key is indicated at the bottom right of the screen.
③	RUN key	Motor motion starts when this key is pressed.
④	STOP/RESET keys	Decelerate to stop or reset the tripping.
⑤	UP/DOWN/LEFT/RIGHT keys & SEL key (centre)	To move between the screen/data use UP/DOWN/LEFT/RIGHT. To select the data, press the SEL key.
⑥	Monitor screen	Display parameters and data.
⑦	RUN LED	Turns ON while RUN command is in execution.
⑧	POWER LED	Turns ON while the keypad is powered-on.

#### 4.1.2 Display mode ⑥

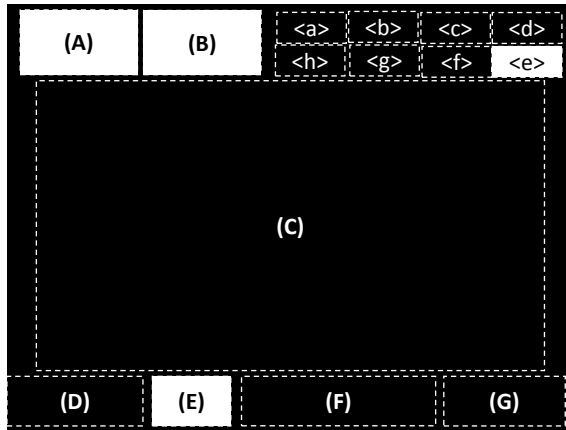

Number	Description
(A)	Operation status.
(B)	Warning status.
(C)	Data/parameters.
(D)	Function assigned to F1 key.
(E)	Function of RUN key.
(F)	Frequency reference, Torque reference, Inverter Name, Clock, etc. Selected by F2 Option
(G)	Function assigned to F2 key.

Number	Name	Description
<a>	Pow	Type of power supply (Input).
<b>	SET	SET terminal for 1st/2nd motor setting.
<c>	Prm	Parameter display mode.
<d>	No.	Screen number.
<e>	STO	Functional Safety. STO
<f>	Cntrl	Control mode.
<g>	EzSQ	EzSQ program.
<h>	Spcl	Special functions.

✧ For more detail, refer to “Chapter 5.2 Confirming the status” or users’ guide.

4.1.3 Monitor mode

✧ For screens not described below, refer to User's Guide. ✧ Pressing F1 key will return to any monitor screen.

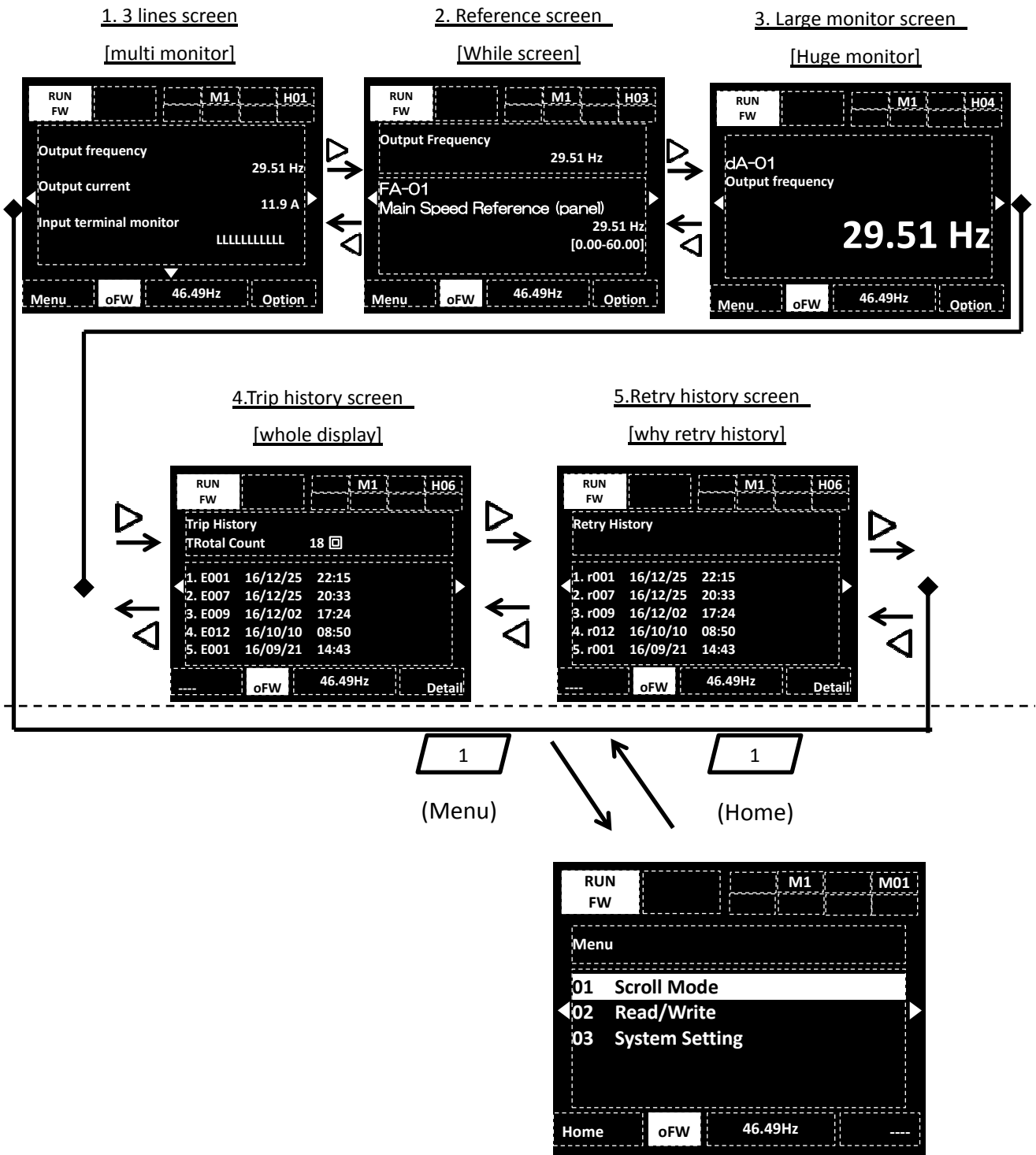

**4.1.3.1. Parameter setting screen**

Change the parameter.

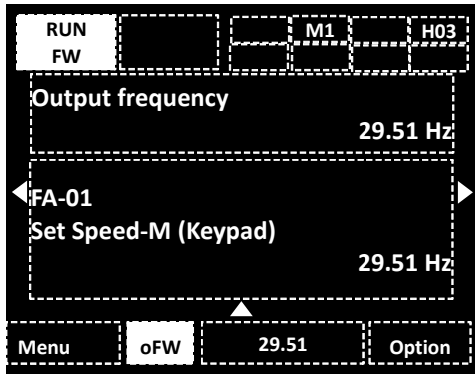

Press the SEL (O) key.



An area in the screen will be highlighted.

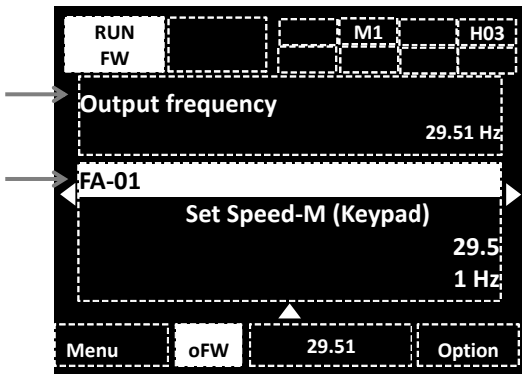

With UP/DOWN (Δ∇) keys select either parameter or monitor area then will be highlighted.



If SEL (O) key is pressed, the parameter code can be changed.

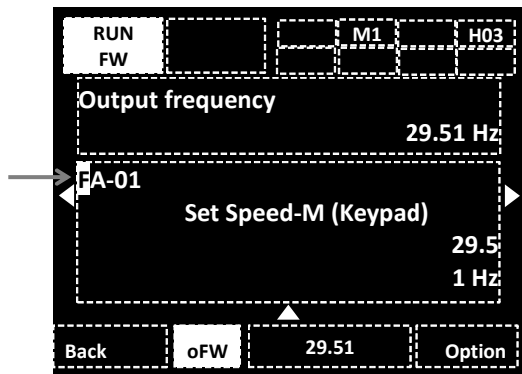

Using UP/DOWN/LEFT/RIGHT (Δ∇◀▶) keys the function code to be monitored can be changed, pressing again the SEL (O) key give access to the function parameter. Press 1 key to return back.

• In the case of a numerical value:

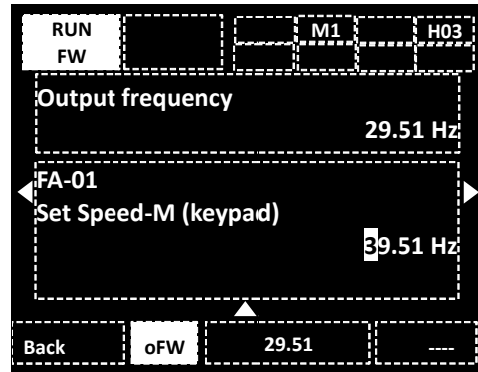

With UP/DOWN/LEFT/RIGHT (Δ∇◀▶) keys change the parameters value,

**And then press the SEL (O) key to save the changes.**

• In the case of a selection menu:

The upper area of the display shows the selected function description.

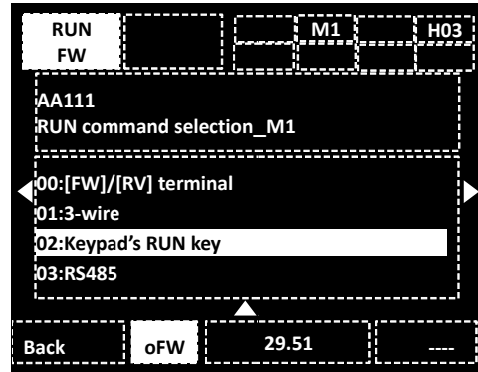

With UP/DOWN (Δ∇) keys you can move between the available choices.

**And then press the SEL (O) key to save the changes.**

**4.1.3.2 3 lines monitor**

To change the monitor details.

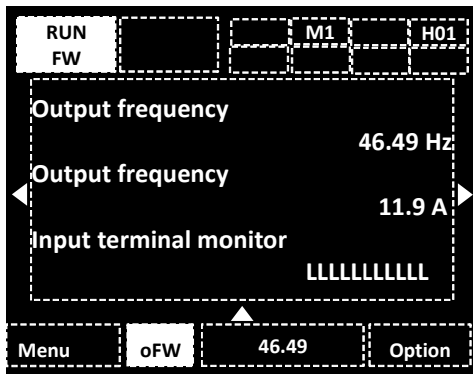

Press the SEL (O) key while on the 3 lines screen, highlighting the first line as result.

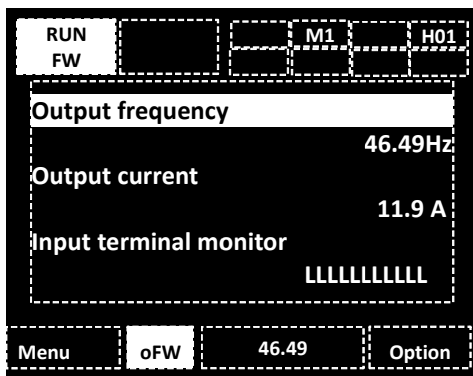

Then with UP/DOWN (Δ∇) is possible to highlight the one desired of the three monitors.

Pressing the SEL (O) key, the code can be accessed.

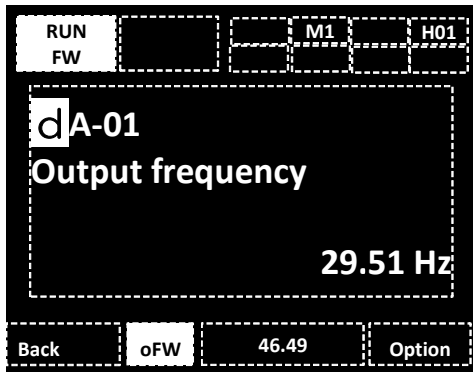

Making use of UP/DOWN/LEFT/RIGHT (Δ∇◀▶) keys, the code of the parameter to be monitored can be changed, and then with the SEL (O) key confirm the change. Press 1 key to return back.

**4.1.3.3 Trip history screen**

On tripping event.

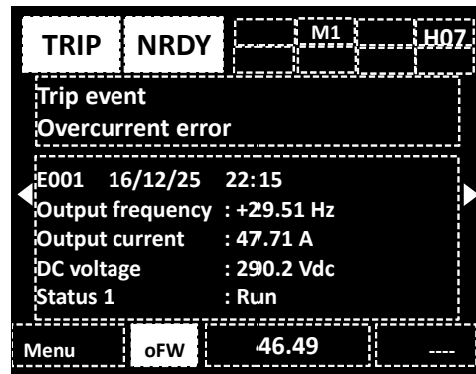

With UP/DOWN (Δ∇) keys, the trip status can be confirmed. Also, the background will become red.

Trip history.

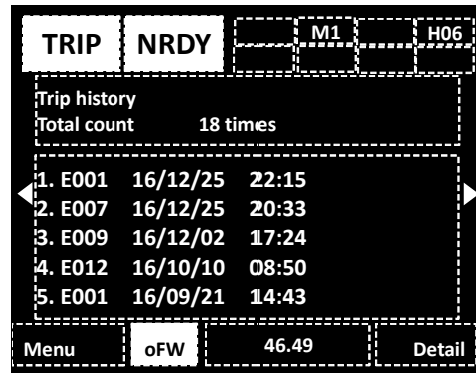

In the Trip history screen press the SEL (O) key, and with UP/DOWN (Δ∇) keys highlight a history, then press SEL (O) key to access the details regarding that trip status.

\*) For more details about the detailed history, please refer to "Chapter 5 Troubleshooting".

\*) Put a battery for using clock function.

**4.1.3.4 Retry History Monitor  
Retry Cause Monitor**

Please refer to user's guide for detail.

4.1.4 Doing a test run...

- This explains the method to how to do a test run using the keypad.

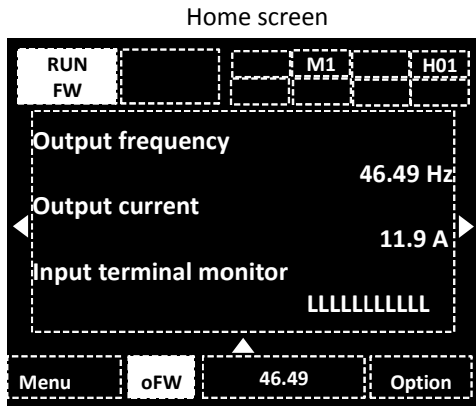

(E)↑ (F)↑

**4.1.4.1 Confirm the operation command.**

- In the position (E) of the upper illustration, when is displayed FW or RV, the RUN key of the keypad is enabled.

⇒Go to [4.1.4.2]

※In the cases that is not displayed, and want to operate from the keypad, or want to change the RUN command reference to FW terminal, is necessary to change the RUN command selection.

⇒Go to [4.1.4.4 Run Command reference change]

**4.1.4.2 Frequency reference status checking.**

- In the upper illustration, in the position (F), when values other than 0.00 are displayed, the frequency reference is already set. ⇒Go to [4.1.4.3]

※In the case that 0.00 is displayed, is necessary to change the value of the frequency reference. In the case that you want to change to an analog input and such, the frequency command selection must be changed.

⇒Go to [4.1.4.5]

**4.1.4.3 Start the output by pressing the RUN key and the motor will accelerate.**

※When the motor does not rotate, please refer to the troubleshooting.

**4.1.4.4 RUN command reference change**

- ① Press the RIGHT(▶) key, after moving to the parameter setting screen and by pressing the SEL(O) key, the parameter section of the parameter setting screen will blink.

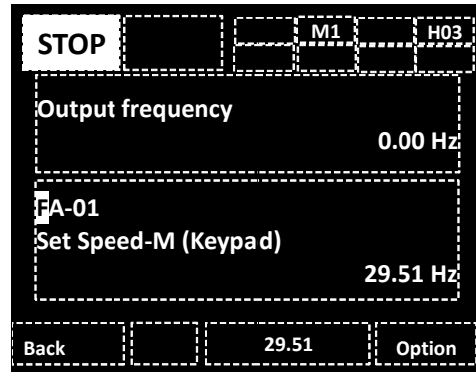

- ② Change the code with UP/DOWN/LEFT/RIGHT(Δ▽◀▶) keys to [AA111].

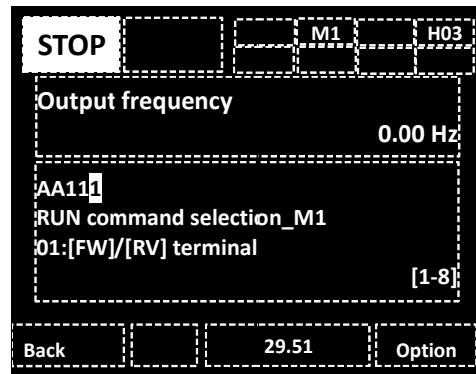

- ③ Press the SEL(O) key and then with UP/DOWN(Δ▽) keys select the RUN operation to be executed between all the choices. In this case [03:Keypad's RUN key] is the one selected.

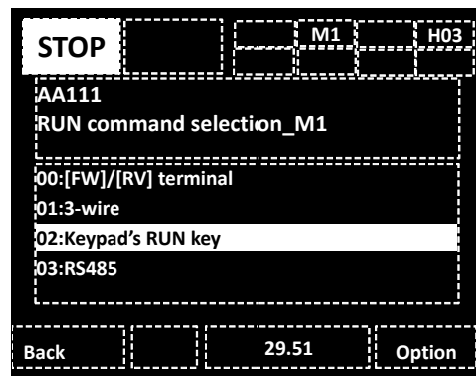

- ④ To save the changes press the SEL (O) key and then in the position (E) FW or RV should be displayed. Press the F1 key, and will go to Home screen.

⇒Go to [4.1.4.2]

**4.1.4.5 Changing frequency reference**

① Press the RIGHT (▶) key and after moving to the parameter setting screen, press the SEL (O) key, the parameter section of the parameter setting screen will blink.

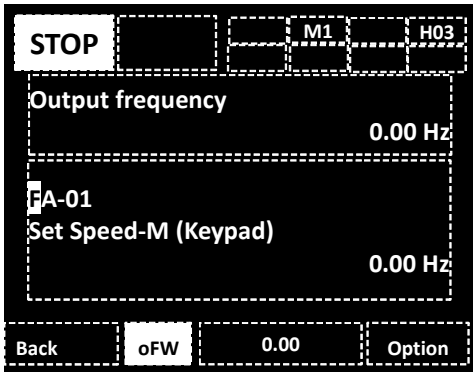

② With UP/DOWN/LEFT/RIGHT(Δ▽◀▶) keys change the code to [FA-01], then [Main speed reference (keypad)] shall be displayed, the frequency setting can be chosen.

⇒Go to ③

If the displayed screen is different, change the frequency reference source. ⇒Go to ⑤

③ Press the SEL(O) key, with UP/DOWN/LEFT/RIGHT(Δ▽◀▶) keys change the frequency value.

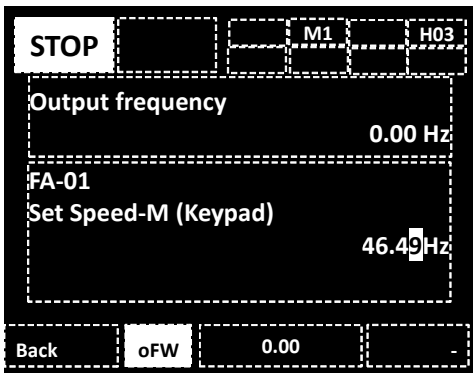

(F)↑

④ To save the changes press the SEL (O) key, and after that in the position (F) should be displayed the set frequency. Press the F1 key, and will go to Home screen. ⇒Go to [4.1.4.3]

⑤ With UP/DOWN/LEFT/RIGHT(Δ▽◀▶) keys change the function code to [AA101].

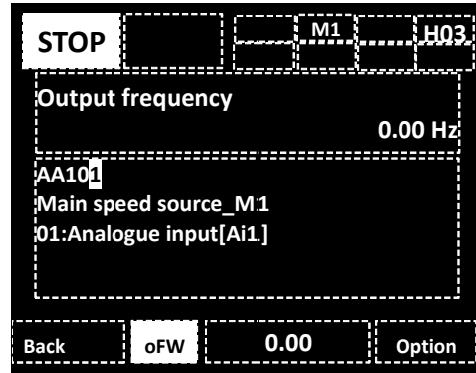

⑥ Press the SEL(O) key and with UP/DOWN(Δ▽) keys, select the frequency reference source to be used. [07:Keypad] is selected in this case.



⑦ To save changes press the SEL (O) key, and then in the position (E), FW or RV should be displayed. Press the F1 key, and will go to Home screen. ⇒Go to [4.1.4.2]

4.1.5 Copying data

Data can be stored in the keypad and then copied to other inverter unit. It is strongly recommended to backup the data just in case.

Refer to user’s guide for a more detailed explanation.

- ① Select R/W from menu

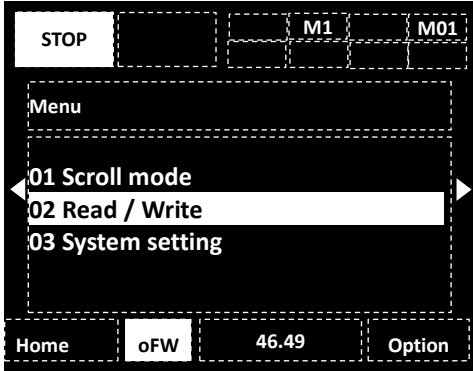

- ② .“Read” function is used for storing the data from the inverter to the keypad.
- ②’ 2-2. “Write” function is used for copying the data stored in the keypad to the inverter (Sequential writing function is used for copying the data one after another)

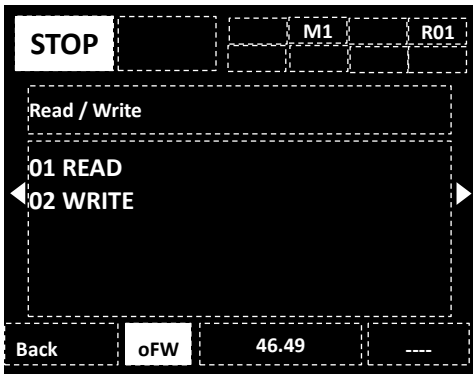

For more information, refer to the user’s guide.

4.1.6 Automatic functions of the keypad

With the system configuration, you can set and adjust keypad related parameters.

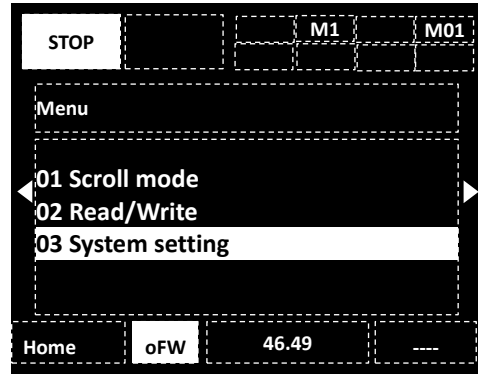

- Available actions in the system configuration

Name	Memo
Language selection	Change the language.
Date function *1)	Time setting, display format, and the settings for the battery warning.
Read lock	Limits the reading property of the data.
R/W write mode	Change the R/W data parameters.
Home automatic transition timer	Sets the time for the automatic home screen return function.
Initial home screen selection	Sets which screen is displayed at the home screen when turns-on.
Brightness	Adjust the brightness of the keypad.
Auto backlight-off function *2)	Set the turn-off time and brightness.
Blinking at trip	Sets the screen blinking when trips.
Background color	Set the background color.
Basic information monitor	Check the software information.
Keypad mode	Use this setting when connecting to older models.
Keypad version	Display the keypad version.
Keypad initialization	Initialize the keypad
Self-diagnostic mode	Will be executed Self-diagnostic mode.

\*1) Battery is required to use date function.

Recommend: Hitachi Maxwell CR2032, 3V

The battery is to be replacing every two years while the inverter is power off.

\*2) The auto backlight-off function will deactivate during in trip status until trip reset. For more information, refer to the user’s guide.

### 4.1.7 To check parameters in scroll mode

In scroll mode, parameter can be change while monitoring. To set parameters by monitoring monitor, please refer to "4.1.3.1 Parameter setting screen

#### 4.1.7.1 try scroll mode

① Press the F1 key on F [[home] screen

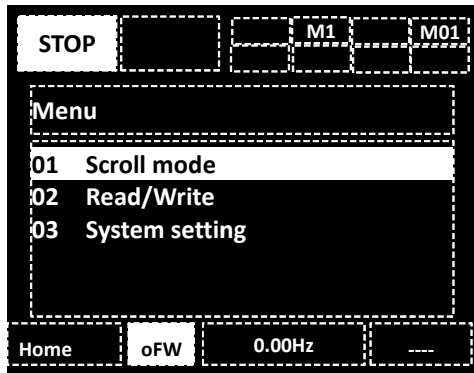
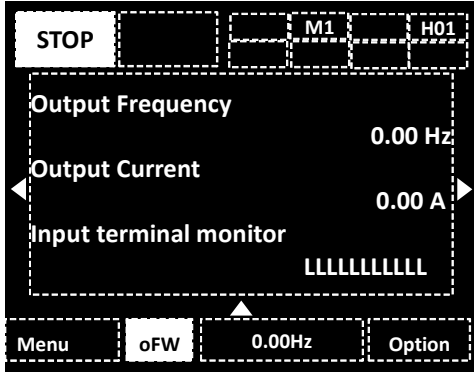

② With UP/DOWN (Δ∇) key select scroll mode to display scroll menu, then, press SEL (0) key to display scroll menu screen.

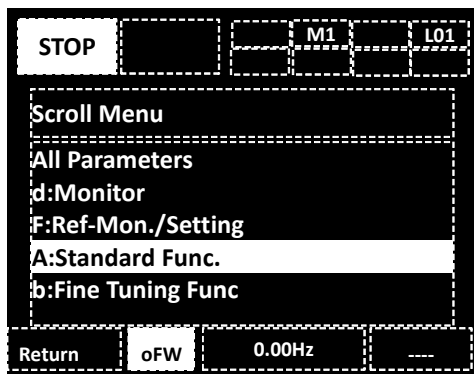

③ Press SEL (0) key follow to UP/DOWN (Δ∇) key select the monitor group, then return to parameter list. For example, selecting "A:Standard Func." then press SEL (0) key.

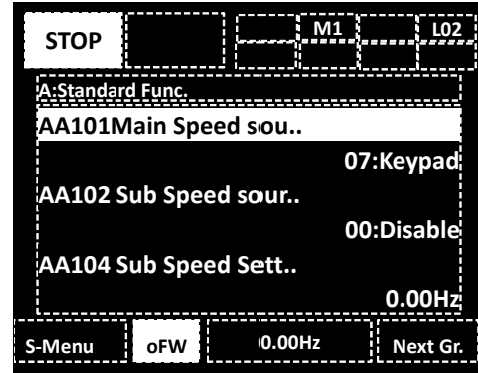

④ Press the SEL (0) key, then, with UP/DOWN (Δ∇) keys select parameters to change.



⑤-1 When the parameter is to be set as alternative, Press UP/DOWN (Δ∇) key to select data and press F2 (Save) key to store then return to parameter list.

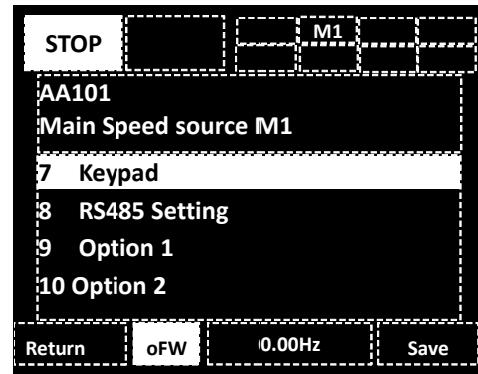

⑤-2 When the parameter is to be set is a numerical value, Press UP/DOWN/LEFT/RIGHT (Δ∇◀▶) key to change data and press F2 (Save) key to store to return to parameter list.

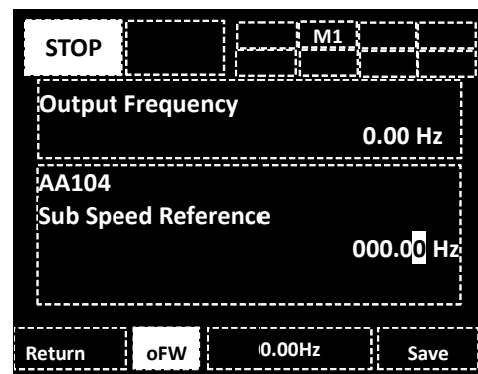

(Tips)

- Press F1 (Return) key to return to parameter list without storing the parameter change.
- Parameter selected for reference screen is show in upper line on ⑤-2.
- When scroll screen is set as initial mode, dA-01, dA-02, dA-03 are displayed as initial setting.



**4.1.7.2 Group Jump Function**

① Press LEFT/RIGHT (◀▶) key to jump to 1<sup>st</sup> parameter of each group.

② When to jump to the detailed subgroup (AA, Ab etc) in parameter group, press F2 key.

A group for example : ...⇒AA⇒Ab⇒AC⇒...⇒AJ⇒AA⇒...

(...⇔All parameters⇔d:Monitor⇔F:Command Monitor/Setting⇔...⇔U:Initial Setting、PDN⇔All Parameters⇔...)

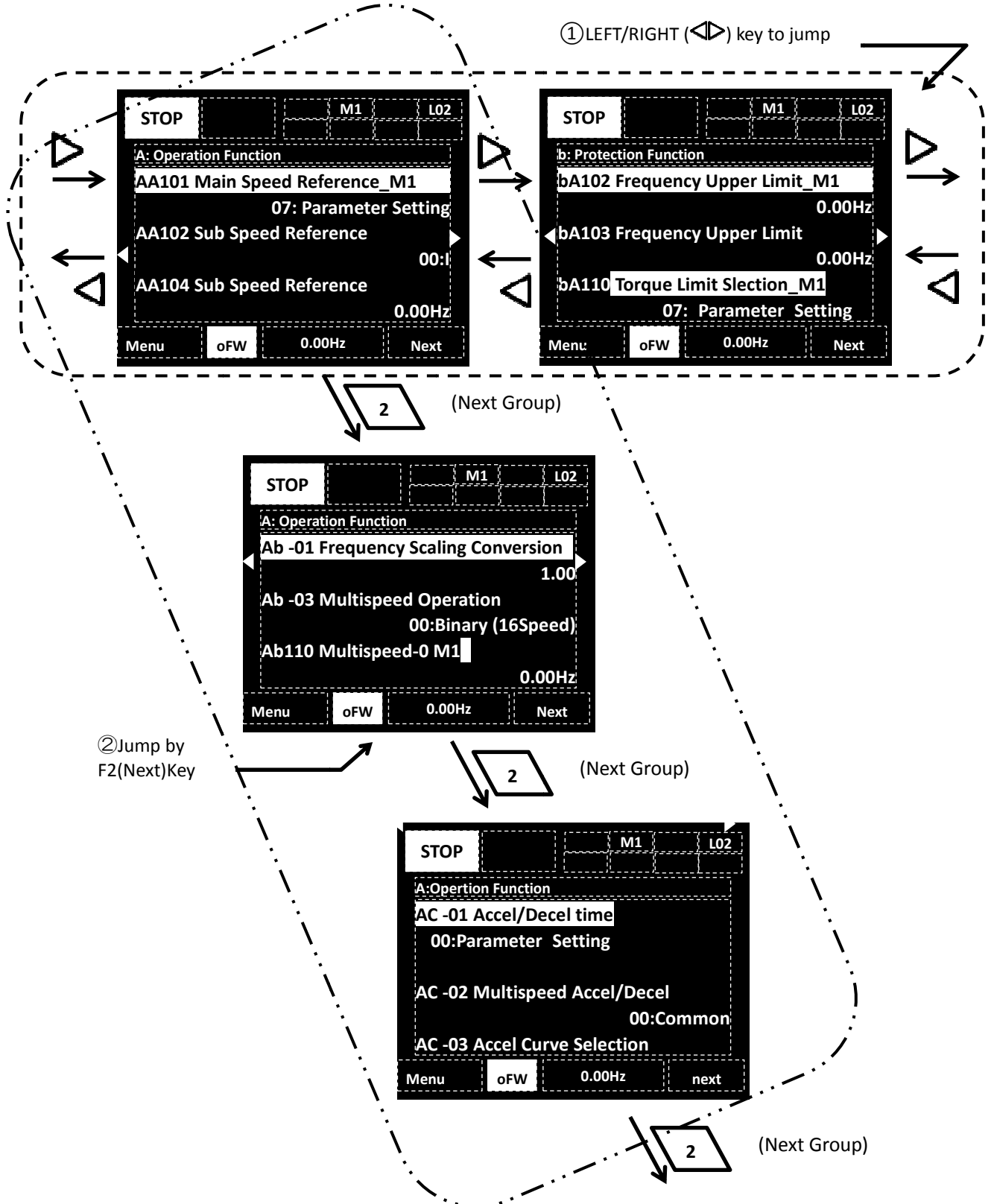

[dA-01]~[dA-41]

[dA-42]~[dA-83][dB-01]~[dB-20]

Monitor naming (Nomenclature)

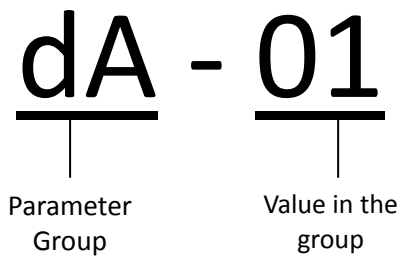

Description of monitor functions

※For more detail, please refer to P1 user's guide.

Monitors for all data

■Monitor mode (d code)

Code/Name	Range (unit)
<b>dA-01</b> Output frequency monitor	0.00~590.00(Hz) <Actual frequency output>
<b>dA-02</b> Output current monitor	0.0~655.35(A)
<b>dA-03</b> Rotation direction monitor	F(forward)/r(reverse)/ d(0Hz output)/o(shut down)
<b>dA-04</b> Frequency reference monitor (After calculation)	0.00~590.00(Hz) <as target value>
<b>dA-06</b> Output frequency scale conversion monitor	0.00~59000.00(Hz)
<b>dA-08</b> Detect speed monitor	-590.00~590.00(Hz) <Encoder feedback required>
<b>dA-12</b> Output frequency monitor (signed)	-590.00~590.00(Hz)
<b>dA-15</b> Torque reference monitor (After calculation)	-500.0~500.0(%) <Torque control mode required>
<b>dA-16</b> Torque limit monitor	-500.0~500.0(%)
<b>dA-17</b> Output Torque monitor	-500.0~500.0(%)
<b>dA-18</b> Output Voltage monitor	0.0~800.0(V)
<b>dA-20</b> Current position monitor	When [AA123]=02 -268435455~+268435455(pulse) When [AA123]=03 -1073741823~+1073741823(pulse)
<b>dA-26</b> Pulse train position deviation monitor	-2147483647~+2147483647(pulse)
<b>dA-28</b> Pulse count monitor	0~2147483647(pulse)
<b>dA-30</b> Input power monitor	0.00~600.00(kW)
<b>dA-32</b> Accumulation input power monitor	0.00~100000.00(kWh)
<b>dA-34</b> Output power monitor	0.00~600.00(kW)
<b>dA-36</b> Accumulated output power monitor	0.00~100000.00 (kWh)
<b>dA-40</b> DC-bus voltage monitor	0.0~1000.0(V)
<b>dA-41</b> BRD load rating monitor	0.00~100.00(%)

Code/Name	Range (unit)
<b>dA-42</b> Electronic thermal load rating monitor (MTR)	0.00~100.00(%)
<b>dA-43</b> Electronic thermal load rating monitor (CTL)	
<b>dA-45</b> Safety STO monitor	00(no input)/01(P-1A)/ 02(P-2A)/03(P-1b)/04(P-2b)/ 05(P-1C)/06(P-2C)/07(STO)
<b>dA-46</b> Safety Option Hardware Monitor	(Refer to FS option guide for detail)
<b>dA-47</b> Safety Option Function Monitor	
<b>dA-50</b> Control terminal status	00(P1-TMA)/01(P1-TMB)/ 02(Others)
<b>dA-51</b> Input terminal monitor	LLLLLLLLL~HHHHHHHHH [L:OFF/H:ON] [Left](B)(A)(9)(8)(7)(6) (5)(4)(3)(2)(1)[Right]
<b>dA-54</b> Output terminal monitor	LLLLLL~HHHHHHH [Left](AL)(16c)(15)(14)(13) (12)(11)[Right]
<b>dA-60</b> Analog input/output status monitor * (1)	AAAAAAA~VVVVVVVV [A:Current/V:Voltage] [Left](EAo2)(EAo1)(Ai6)(Ai5) (Ao2)(Ao1)(Ai2)(Ai1)[Right]
<b>dA-61</b> Analog input [Ai1] monitor	0.00~100.00(%)
<b>dA-62</b> Analog input [Ai2] monitor	
<b>dA-63</b> Analog input [Ai3] monitor	-100.00~100.00(%)
<b>dA-64</b> Analog input [Ai4] monitor	-100.00~100.00(%)
<b>dA-65</b> Analog input [Ai5] monitor	0.00~100.00(%)
<b>dA-66</b> Analog input [Ai6] monitor	
<b>dA-70</b> Pulse train input monitor (internal)	0.00~100.00(%)
<b>dA-81</b> Option slot-1 status	00:(none)/01:(P1-EN)/ 02:(P1-DN)/03:(P1-PB)/ 04:(P1-FB)/05:(P1-RLV)/ 06:(P1-DG)/07:(P1-AIO)/ 08:(P1-RY)/09:(P1-TMP)/ 10:(P1-FS)
<b>dA-82</b> Option slot-2 status	
<b>dA-83</b> Option slot-3 status	

\*(1)dA-60 is available also for the terminals of the option terminal board

## [db-01]~[db-64]

Code/Name	Range (unit)
<b>db-01</b> Program download monitor	00(Program is not installed)/ 01(Program is installed)
<b>db-02</b> Program No. monitor	0000~9999
<b>db-03</b> Program counter (Task-1)	0~1024
<b>db-04</b> Program counter (Task-2)	
<b>db-05</b> Program counter (Task-3)	
<b>db-06</b> Program counter (Task-4)	
<b>db-07</b> Program counter (Task-5)	
<b>db-08</b> User monitor -0	-2147483647 ~+2147483647
<b>db-10</b> User monitor -1	
<b>db-12</b> User monitor -2	
<b>db-14</b> User monitor -3	
<b>db-16</b> User monitor -4	
<b>db-18</b> Analog output monitor YA0	0~10000
<b>db-19</b> Analog output monitor YA1	
<b>db-20</b> Analog output monitor YA2	
<b>db-21</b> Analog output monitor YA3	
<b>db-22</b> Analog output monitor YA4	
<b>db-23</b> Analog output monitor YA5	

Code/Name	Range (unit)
<b>db-30</b> PID1 feedback value 1 monitor	0.00~100.00(%)
<b>db-32</b> PID1 feedback value 2 monitor	
<b>db-34</b> PID1 feedback value 3 monitor	
<b>db-36</b> PID2 feedback value monitor	
<b>db-38</b> PID3 feedback value monitor	
<b>db-40</b> PID4 feedback value monitor	0.00~100.00(%)
<b>db-42</b> PID1 target value monitor	
<b>db-44</b> PID1 feedback value monitor	0.00~100.00(%)
<b>db-50</b> PID1 output monitor	-100.00~+100.00(%)
<b>db-51</b> PID1 deviation monitor	-100.00~+100.00(%)
<b>db-52</b> PID1 deviation 1 monitor	
<b>db-53</b> PID1 deviation 2 monitor	
<b>db-54</b> PID1 deviation 3 monitor	-100.00~+100.00(%)
<b>db-55</b> PID2 Output monitor	
<b>db-56</b> PID2 deviation monitor	-100.00~+100.00(%)
<b>db-57</b> PID3 Output monitor	-100.00~+100.00(%)
<b>db-58</b> PID3 deviation monitor	-100.00~+100.00(%)
<b>db-59</b> PID4 Output monitor	-100.00~+100.00(%)
<b>db-60</b> PID4 deviation monitor	-100.00~+100.00(%)
<b>db-61</b> Current PID P-Gain monitor	0.0~100.0
<b>db-62</b> Current PID I-Gain monitor	0.0~3600.0(s)
<b>db-63</b> Current PID D-Gain monitor	0.0~100.0(s)
<b>db-64</b> PID feedforward monitor	0.00~100.00(%)

## [dC-01]~[dC-50]

Code/Name	Range (unit)
<b>dC-01</b> Inverter load type status	00(Very Low duty)/ 01(Low duty)/ 02(Normal duty)
<b>dC-02</b> Rated current monitor	1)
<b>dC-07</b> Main speed input source monitor	1)
<b>dC-08</b> Sub speed input source monitor	1)
<b>dC-10</b> RUN command input source monitor	1)
<b>dC-15</b> Cooling fin temperature monitor	-20.0~200.0(°C)
<b>dC-16</b> Life assessment monitor	LL~HH [L:Normal/H:Fatigued] [Left](FAN lifespan) (board capacitor life span)[Right]
<b>dC-20</b> Accumulation Start number monitor	1~65535(cycles)
<b>dC-21</b> Accumulation Power-on timer monitor	
<b>dC-22</b> Accumulated time monitor in RUN status monitor	1~1000000(hour)
<b>dC-24</b> Accumulation Power-on time monitor	
<b>dC-26</b> Accumulation cooling-fan running time monitor	
<b>dC-37</b> icon 2 LIM monitor	
<b>dC-38</b> icon 2 ALT monitor	
<b>dC-39</b> icon 2 RETRY detail monitor	
<b>dC-40</b> icon 2 NRDY detail monitor	
<b>dC-45</b> IM/SM monitor	00 (IM selected)/ 01 (SM selected)
<b>dC-50</b> Firmware ver. Monitor	00.000~99.99

1) Refer to users guide for detail

Code/Name	Range (unit)
<b>dE-50</b> warning monitor	Refer to users guide

**[FA-01]~[FA-36]**

## ■ Variable mode monitor (F code)

- If a [FA] parameter that can be modified is selected, it can be modified in the display monitor.

Code/Name	Range (unit)
<b>FA-01</b> Main speed reference monitor	0.00~590.00(Hz)
<b>FA-02</b> Sub-speed reference monitor	
<b>FA-10</b> Acceleration time monitor	0.00~3600.00(s)
<b>FA-12</b> Deceleration time monitor	
<b>FA-15</b> Torque reference monitor	-500.0~500.0(%)
<b>FA-16</b> Torque bias monitor	-500.0~500.0(%)
<b>FA-20</b> Position reference monitor	When [AA123]=02 -268435455~+268435455(pulse) When [AA123]=03 -1073741823~+1073741823(pulse)
<b>FA-30</b> PID1 set value 1 monitor	-100.00~100.00(%)
<b>FA-32</b> PID1 set value 2 monitor	
<b>FA-34</b> PID1 set value 3 monitor	
<b>FA-36</b> PID2 set value monitor	
<b>FA-38</b> PID3 set value monitor	
<b>FA-40</b> PID4 set value monitor	

Parameter naming (Nomenclature)

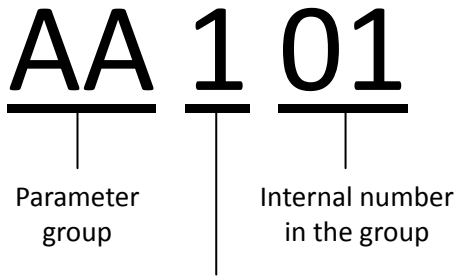

- : Common for 1st and 2nd motor
- 1 : 1st motor enabled if function [SET] is OFF
- 2 : 2nd motor enabled if function [SET] is ON

※By default the motor 1 is enabled in the case that 08:[SET] is not assigned in the Intelligent Input terminals [CA-01]~[CA-11].

[SET] function enable code example.

[SET]OFF	[SET]ON
[**.**] type	[**.**] type
[**1**] type	[**2**] type

(Example)

[SET]OFF	[SET]ON
[AH-01]	[AH-01]
[Ub-01]	[Ub-01]
. . .	. . .
[Hb102]	[Hb202]
[Ab110]	[Ab210]
[bA122]	[bA222]
. . .	. . .

※When using 2nd motor parameter setting by [SET] function of terminal, description as 1st motor setting in the following part is to be replaced with that of 2nd motor setting.

4.5Parameter arrangement

Next is the parameter explanation, such as the parameter group and the internal group number line-up. The [SET] classification numbers “-” and “1” are lined without distinction, except “2” which is lined-up after “-” and “1”.

Example) Regarding the order

[AA101]⇒[AA102]⇒[AA104]⇒[AA105]⇒...

⇒[AA123]⇒[AA201]⇒...⇒[AA223]⇒

[Ab-01]⇒[Ab-03]⇒[Ab110]⇒[Ab-11]⇒...

(Last two digits are order by numerical order)

⇒[Ab-25]⇒[Ab210]⇒

[AC-01]⇒...

(After the middle values of “-” and “1”, using “2” changes the group)

※Related parameters might be described together in relevant parts.

[AA101]~[AA106]

Parameter explanation

Working parameters

- To set parameters, please read an understand the P1 user’s guide first.
- For the motor protection, the following parameters are necessary to be set.
  - [Hb102]~[Hb108](If [IM])
  - [Hd102]~[Hd108](If [SM/PMM])
  - [bc110](Motor overload protection current)

※The initial value format may be different.

Format: P1-(numeral)-(voltage)(keypad)(area)(filter)

(Example) Japan 200V Class P1-00044-LFF

Europe 400V Class P1-00054-HFEF

Voltage rating: The voltage class is L(200V)/H(400V)

Other formats:

Area; None(JPN)/E(EU,ASIA)/U(USA)/C(CHN)

※When option is connected, parameters to display or setting range may be added. Refer to user’s guide for detail.

■Parameter mode (A code)

Frequency reference selection

Code/Name	Range (unit)	Initial value
<b>AA101</b> Main speed input source selection, 1st-motor	01~16 *1)	09(JPN)/ 01(EU)(USA) (ASIA)(CHN)
<b>AA102</b> Sub speed input source selection, 1st-motor	00~16 *1)	00
<b>AA104</b> Sub speed setting, 1st-motor	0.00~590.00(Hz)	0.00
<b>AA105</b> Calculation symbol selection for Speed reference, 1 <sup>st</sup> motor	00(Disable)/ 01(Addition)/ 02(Subtraction)/ 03(Multiplication)	00

\*1)00(Disable)/01(Ai1 terminal)/02(Ai2 terminal)/03(Ai3 terminal)/09(Parameter)/10(By RS485)/11(Option-1)/12(Option-2)/13(Option-3)/14(Pulse train input:main)/16(EzSQ)/17(PID function)

• To change the frequency input reference, use [AA111].

Example: to set by [FA-01] -> [AA101]=07

To set by Analog(voltage) to set -> [AA101]=01(Ai1)

- To change between main and sub speed is possible with the math operator.
- If [AA105]=00, the Intelligent input terminal 032[SchG] can change between the main(OFF) and sub(ON) speed.
- Through the [AA105] selection, the operator for the main and sub speed frequency calculation is set.

Temporary frequency addition

Code/Name	Range (unit)	Initial value
<b>AA106</b> Add frequency setting, 1st-motor	-590.00~+590.00(Hz)	0.00

• When the [ADD] terminal is active the frequency set in [AA106] will be temporarily added to the frequency reference.

[AA111]~[AA115][bb-40]

**RUN command selection**

Code/Name	Range (unit)	Initial value
<b>AA111</b> RUN command input source selection, 1st-motor	00~03	02(JPN)/ 00(EU) (USA) (ASIA) (CHN)

\*1) 00([FW]/[RV] terminal)/01(3-wire)/02(Keypad's RUN key)/03(RS485)

- Select in which way will be operated. In case it does not work, please review it.

**Keypad keys settings**

Code/Name	Range (unit)	Initial value
<b>AA-12</b> RUN key of keypad rotation direction, 1st-motor	00(Forward)/ 01(Reverse)	00
<b>AA-13</b> STOP key enable at RUN command from terminal, 1st-motor	00(Disable)/01(Enable)/ 02(Enable only at trip)	01

- [AA-12] specifies in which direction (forward/reverse) will be the rotation after pressing the RUN key in the operation keypad.
- [AA-13] changes the operation of the STOP key. Independently of the actual setting of the STOP key it performs a stop. The STOP circumstances can be changed only by the setting selected in [AA-13].

**RUN command direction restriction**

Code/Name	Range (unit)	Initial value
<b>AA114</b> RUN direction restriction, 1st-motor	00(No restriction)/ 01(Only forward)/ 02(Only reverse)	00

- It will avoid that the output goes over the imposed limitation in case of a mistaken operation.

**Restart operation after decel/free-run STOP**

Code/Name	Range (unit)	Initial value
<b>AA115</b> STOP mode selection, 1st-motor	00(Deceleration stop)/ 01(Free-run stop)	00
<b>bb-40</b> Restart mode after FRS release	00(Start with 0Hz)/ 01(Start with frequency matching)/ 02(Start with Active frequency matching)/ 03(Detect speed)	00

- For when a stop command is executed, deceleration stop or free-run stop can be selected.
- If input terminal 032[FRS] is active (ON), free-run stop is possible.
- With [bb-40], a restart with the release of the [FRS], or a restart operation that will be executed after the full stop of the free-run can be selected.
- In free-run stop it can be configured to stop by inertia if the [E007] overvoltage error occurs during deceleration (The torque will be lost).

[AA121]~[AA223]

**Control mode selection**

Code/Name	Range (unit)	Initial value
<b>AA121</b> Control mode selection, 1st-motor	00~03, 08, 09, 11 *2)	00

\*2) IM control: 00([V/f] constant torque)/01([V/f] reduced torque)/  
02([V/f] Free V/f)/03([V/f] constant torque with Automatic-trq boost)/  
08(Sensorless vector control)/  
09(0Hz-area sensorless vector control)/  
SM/PMM control: 11(Sensorless vector control (SM/PMM))

- Generally for a light duty control (such as fans or pumps), the [V/f] control with constant torque or the [V/f] control with reduced torque are more closer to the operation characteristics of fans and pumps.
- For heavy duty (Cranes, etc...), sensorless vector control is the typically used. In the case there is an encoder, use the vector control with encoder.
- For a magnet motor select the sensorless vector control (SM/PMM).
- ✘With a standard duty (ND) all the options are available, but for Light and Very Light duty (LD/VLD) the option 09 is not available.

**Vector control with encoder mode**

Code/Name	Range (unit)	Initial value
<b>AA123</b> Vector control mode selection, 1st-motor	00(Speed/Torque control mode)/ 01(Pulse train position control)/ 02(Position control)/ 03(High-resolution position control)	00

- For Vector control with encoder ([A121]=10) select Speed/Torque control (00) or Position control (02).
- For more information, refer to the user's guide.

**2nd motor** When Intelligent Input terminal 024[SET] is enabled.

Code/Name	Range (unit)	Initial value
<b>AA201</b> Main speed input source selection, 2nd-motor	Same as AA101	
<b>AA202</b> Sub speed input source selection, 2nd-motor	Same as AA102	
<b>AA204</b> Sub speed setting, 2nd-motor	Same as AA104	
<b>AA205</b> Calculation symbol selection for speed reference, 2nd-motor	Same as AA105	
<b>AA206</b> Add frequency setting, 2nd-motor	Same as AA106	
<b>AA211</b> RUN-command input source selection, 2nd-motor	Same as AA111	
<b>AA214</b> RUN-direction restriction selection, 1st-motor	Same as AA114	
<b>AA215</b> STOP mode selection, 1st-motor	Same as AA115	
<b>AA221</b> Control mode selection 2nd-motor	Same as AA121	
<b>AA223</b> Vector control mode selection, 2nd-motor	Same as AA123	

[Ab-01]~[Ab-25]

**Scaled Output Frequency gain monitor [dA-06]**

Code/Name	Range (unit)	Initial value
<b>Ab-01</b> Frequency conversion gain	0.00~100.00	1.00

• The visualized “Scaled Output frequency [dA-06]” is equal to the “Output frequency [dA-01]” multiplied by the “Frequency scaling conversion factor[Ab-01]”.

**Multispeed command**

Code/Name	Range (unit)	Initial value
<b>Ab-03</b> Multispeed operation selection	00(16 speeds)/01(8 speeds)	00
<b>Ab110</b> Multispeed-0, 1st-motor	0.00~590.00(Hz)	0.00
<b>Ab-11</b> Multispeed-1, 1st-motor	0.00~590.00(Hz)	0.00
<b>Ab-12</b> Multispeed-2, 1st-motor	0.00~590.00(Hz)	0.00
<b>Ab-13</b> Multispeed-3, 1st-motor	0.00~590.00(Hz)	0.00
<b>Ab-14</b> Multispeed-4, 1st-motor	0.00~590.00(Hz)	0.00
<b>Ab-15</b> Multispeed-5, 1st-motor	0.00~590.00(Hz)	0.00
<b>Ab-16</b> Multispeed-6, 1st-motor	0.00~590.00(Hz)	0.00
<b>Ab-17</b> Multispeed-7, 1st-motor	0.00~590.00(Hz)	0.00
<b>Ab-18</b> Multispeed-8, 1st-motor	0.00~590.00(Hz)	0.00
<b>Ab-19</b> Multispeed-9, 1st-motor	0.00~590.00(Hz)	0.00
<b>Ab-20</b> Multispeed-10, 1st-motor	0.00~590.00(Hz)	0.00
<b>Ab-21</b> Multispeed-11, 1st-motor	0.00~590.00(Hz)	0.00
<b>Ab-22</b> Multispeed-12, 1st-motor	0.00~590.00(Hz)	0.00
<b>Ab-23</b> Multispeed-13, 1st-motor	0.00~590.00(Hz)	0.00
<b>Ab-24</b> Multispeed-14, 1st-motor	0.00~590.00(Hz)	0.00
<b>Ab-25</b> Multispeed-15, 1st-motor	0.00~590.00(Hz)	0.00

• For the 16 speeds selection, set [Ab-03]=03 for assigning the intelligent terminals 003[CF1] to 006[CF4] makes available the use of the speeds 0 to 15.

Multispeed	CF4	CF3	CF2	CF1
Speed 0	OFF	OFF	OFF	OFF
Speed 1	OFF	OFF	OFF	ON
Speed 2	OFF	OFF	ON	OFF
Speed 3	OFF	OFF	ON	ON
Speed 4	OFF	ON	OFF	OFF
Speed 5	OFF	ON	OFF	ON
Speed 6	OFF	ON	ON	OFF
Speed 7	OFF	ON	ON	ON
Speed 8	ON	OFF	OFF	OFF
Speed 9	ON	OFF	OFF	ON
Speed 10	ON	OFF	ON	OFF
Speed 11	ON	OFF	ON	ON
Speed 12	ON	ON	OFF	OFF
Speed 13	ON	ON	OFF	ON
Speed 14	ON	ON	ON	OFF
Speed 15	ON	ON	ON	ON

[Ab210][AC-01]~[AC-02]

• For the 8 speeds selection, set [Ab-03]=01 assigning the intelligent terminals 007[SF1] to 013[SF7] makes available the use of the speeds 0 to 7.

Multispeed	SF7	SF6	SF5	SF4	SF3	SF2	SF1
Speed 0	OFF	OFF	OFF	OFF	OFF	OFF	OFF
Speed 1	-	-	-	-	-	-	ON
Speed 2	-	-	-	-	-	ON	OFF
Speed 3	-	-	-	-	ON	OFF	OFF
Speed 4	-	-	-	ON	OFF	OFF	OFF
Speed 5	-	-	ON	OFF	OFF	OFF	OFF
Speed 6	-	ON	OFF	OFF	OFF	OFF	OFF
Speed 7	ON	OFF	OFF	OFF	OFF	OFF	OFF

**2nd motor** When Intelligent Input terminal 024[SET] is enabled.

Code/Name	Range (unit)	Initial value
<b>Ab210</b> Multispeed-0, 2nd-motor	Same as Ab110	

**Input method for Acc/Decel time**

Code/Name	Range (unit)	Initial value
<b>AC-01</b> Acceleration/Deceleration Time input selection	00(Parameter)/01(Option 1)/02(Option 2)/03(Option 3)/04(Function EzSQ)	00

• [AC-01] changes the reference target for the Acc/Decel command.

**Individual Acc/Decel for Multispeed**

Code/Name	Range (unit)	Initial value
<b>AC-02</b> Acceleration/Deceleration selection	00(Common)/01(Multi)	00

- When [AC-02]=00, the acceleration/deceleration time settings [AC120][AC122] or [AC124][AC126] will be in effect.
- 2-stage acceleration/deceleration functions from [AC115] to [AC117] can be set.
- When [AC-02]=01, the acceleration/deceleration time [AC-30]~[AC-88] for each multispeed control (from speed 1 to 15) are enabled.
- When [AC-02]=01, while in Multispeed-0 command, Acc/Decel setting [AC120] [AC122] or Acc/Decel setting [AC124] [AC126] are enabled.
- During remote control up/down [FUP]/[FDN] (parameters [CA-64] and [CA-66]) and PID soft start (parameter [AH-78]), those parameters can be overwritten.

[AC-03]~[AC117]

Acceleration/deceleration curve selection

Code/Name	Range (unit)	Initial value
<b>AC-03</b> Acceleration curve selection	00(Linear)/ 01(S-curve)/ 02(U-curve)/	00
<b>AC-04</b> Deceleration curve selection	03(Inverted-U-curve)/ 04(EL-S-curve)	00
<b>AC-05</b> Acceleration curve constant setting	1~10	2
<b>AC-06</b> Deceleration curve constant setting		2
<b>AC-08</b> EL-S-curve ratio at start of acceleration 1	0~100	25
<b>AC-09</b> EL-S-curve ratio at end of acceleration 2		25
<b>AC-10</b> EL-S-curve ratio at start of deceleration 1		25
<b>AC-11</b> EL-S-curve ratio at end of deceleration 2		25

- When [AC-03]/[AC-04]=00(Linear), decelerates at regular intervals towards the target value.
- When [AC-03]/[AC-04]=01(S-curve), for a shockless operation proceeds gradually at the beginning and at the end of the acceleration and deceleration.
- When [AC-03]/[AC-04]=02(U-curve), proceeds gradually at the start of the acceleration and deceleration.
- When [AC-03]/[AC-04]=03(Inverted-U-curve), proceeds gradually at the end of the acceleration and deceleration.
- For S-curve, U-curve and Inverted-U-curve, the degree in which the operation accelerates and decelerates can be set with [AC-05]/[AC-06].
- When AC-03]/[AC-04]=04 (EL-S-curve), proceeds gradually at the beginning and the end of the acceleration and deceleration.
- For EL-S-curve shockless operation, the beginning and the end of the acceleration and deceleration [AC-08]~[AC-11] should be adjusted.

Two-stage Acc/Decel change

Code/Name	Range (unit)	Initial value
<b>AC115</b> Select method to switch to Acc2/Decel2 profile, 1st-motor	00([2CH] terminal)/ 01(Set by parameter)/ 02(Switch only when rotation is inverted)	00
<b>AC116</b> Acc1 to Acc2 frequency transition point, 1st-motor	0.00~590.00(Hz)	0.00
<b>AC117</b> Decel1 to Decel2 frequency transition point, 1st-motor		0.00

- In the Acc2/Decel2 time, forward/reverse change can be done when intelligent input terminal 031[2CH] is ON and the set frequency in [AC116]/ [AC117] is reached.
- Sets Acc/Decel time 1[AC120][AC122] and Acc/Decel time 2 [AC124] [AC126].

[AC120]~[AC126]

Acceleration/deceleration time setting

Code/Name	Range (unit)	Unit value
<b>AC120</b> Acceleration time setting 1, 1st-motor	0.00~3600.00(s)	30.00
<b>AC122</b> Deceleration time setting 1, 1st-motor		30.00
<b>AC124</b> Acceleration time setting 2, 1st-motor		15.00
<b>AC126</b> Deceleration time setting 2, 1st-motor		15.00

- Assign the Acc/Decel time that takes from 0Hz to reach the maximum frequency.
- In case that the two-stage Acc/Decel function is not meant to be used, the Acceleration time 1 [AC120] and Deceleration time 1 [AC122] are used.

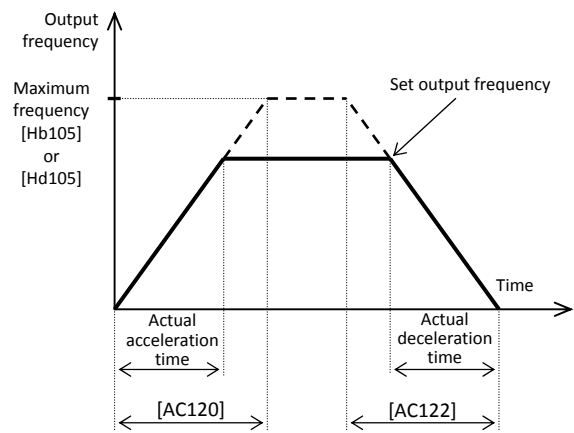

- Example of using the two-stage Acc/Decel function. With[AC115]=00

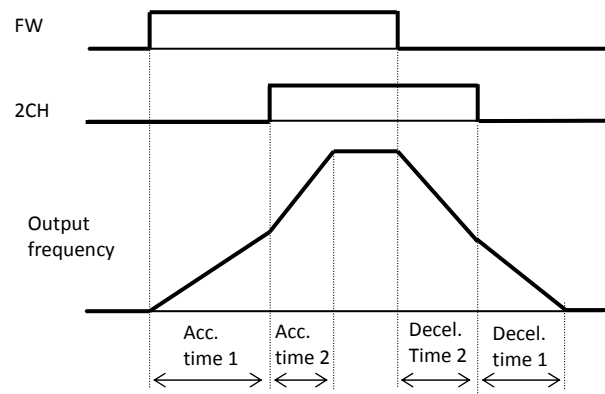

\*) Acc/Decel time is what takes from 0Hz to reach the maximum frequency.



[AC-30]~[AC-88]

Setting for two-stage Acc/Decel time

Code/Name	Range (unit)	Unit value
<b>AC-30</b> Acc. time for Multispeed-1	0.00~ 3600.00(s)	30.00
<b>AC-32</b> Decel. time for Multispeed-1		30.00
<b>AC-34</b> Acc. time for Multispeed-2		30.00
<b>AC-36</b> Decel. time for Multispeed-2		30.00
<b>AC-38</b> Acc. time for Multispeed-3		30.00
<b>AC-40</b> Decel. time for Multispeed-3		30.00
<b>AC-42</b> Acc. time for Multispeed-4		30.00
<b>AC-44</b> Decel. time for Multispeed-4		30.00
<b>AC-46</b> Acc. time for Multispeed-5		30.00
<b>AC-48</b> Decel. time for Multispeed-5		30.00
<b>AC-50</b> Acc. time for Multispeed-6		30.00
<b>AC-52</b> Decel. time for Multispeed-6		30.00
<b>AC-54</b> Acc. time for Multispeed-7		30.00
<b>AC-56</b> Decel. time for Multispeed-7		30.00
<b>AC-58</b> Acc. time for Multispeed-8		30.00
<b>AC-60</b> Decel. time for Multispeed-8		30.00
<b>AC-62</b> Acc. time for Multispeed-9		30.00
<b>AC-64</b> Decel. time for Multispeed-9		30.00
<b>AC-66</b> Acc. time for Multispeed-10		30.00
<b>AC-68</b> Decel. time for Multispeed-10		30.00
<b>AC-70</b> Acc. time for Multispeed-11		30.00
<b>AC-72</b> Decel. time for Multispeed-11		30.00
<b>AC-74</b> Acc. time for Multispeed-12		30.00
<b>AC-76</b> Decel. time for Multispeed-12		30.00
<b>AC-78</b> Acc. time for Multispeed-13		30.00
<b>AC-80</b> Decel. time for Multispeed-13		30.00
<b>AC-82</b> Acc. time for Multispeed-14		30.00
<b>AC-84</b> Decel. time for Multispeed-14		30.00
<b>AC-86</b> Acc. time for Multispeed-15		30.00
<b>AC-88</b> Decel. time for Multispeed-15		30.00

- Individual Acc/Decel times can be set for multispeed functions[Ab-11]~[Ab-25].

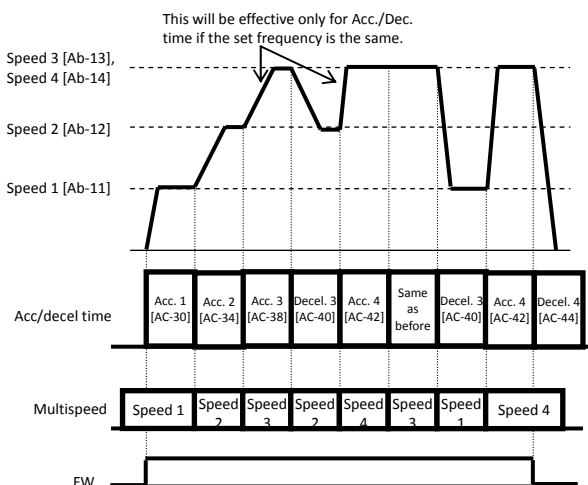

[AC215]~ [Ad-15]

2nd motor When Intelligent Input terminal 024[SET] is enabled.

Code/Name	Range (unit)	Initial value
<b>AC215</b> Select method to switch to Acc2/Decel2 Profile, 2nd-motor	Same as AC115	
<b>AC216</b> Acc1 to Acc2 frequency transition point, 2nd-motor	Same as AC116	
<b>AC217</b> Decel1 to Decel2 frequency transition point, 2nd-motor	Same as AC117	
<b>AC220</b> Acceleration time 1, 2nd-motor	Same as AC120	
<b>AC222</b> Deceleration time 1, 2nd-motor	Same as AC122	
<b>AC224</b> Acceleration time 2, 2nd-motor	Same as AC124	
<b>AC226</b> Deceleration time 2, 2nd-motor	Same as AC126	

Torque control function setting

Code/Name	Range (unit)	Initial value
<b>Ad-01</b> Torque reference input source selection	01~06/09~18 *1)	07
<b>Ad-02</b> Torque reference value setting	-500.0~500.0(%)	0.0
<b>Ad-03</b> Polarity selection for torque reference	00(According to sign)/ 01(Depend on the operation direction)	00
<b>Ad-04</b> Switching time of speed control to torque control	0~1000(ms)	0

- Operations settings of torque control.  
For more information, refer to the User's guide.

Torque bias setting

Code/Name	Range (unit)	Initial value
<b>Ad-11</b> Torque bias input source selection	01~06/09~18 *1)	07
<b>Ad-12</b> Torque bias value setting	-500.0~500.0(%)	0.0
<b>Ad-13</b> Polarity selection for torque bias	00(According to sign)/ 01(Depend on the operation direction)	00
<b>Ad-14</b> Terminal [TBS] active	00(Disable)/ 01(Enable)	00

- For setting the torque bias.  
For more information, refer to the User's guide.

Speed limitation for torque control

Code/Name	Range (unit)	Initial value
<b>Ad-40</b> Input selection for speed limit at torque control	01~13 *1)	07
<b>Ad-41</b> Speed limit at torque control (at Forward rotation)	0.00~ 590.00(Hz)	0.00
<b>Ad-42</b> Speed limit at torque control (at Reverse rotation)		0.00

- In middle of the torque control the speed limit can be set.

For more information, refer to the User's guide.

\*1)00(Disable)/01(Ai1 terminal)/02(Ai2 terminal)/03(Ai3 terminal)/07(Parameter)/08(RS485)/13(Pulse train input:main)/ 14(Program function)/15(PID calc.)

## [AE-01]~[AE-13]

## Position control

Code/Name	Range (unit)	Initial value
<b>AE-01</b> Electronic gear setting point selection	00(Feedback)/01(Reference)	00
<b>AE-02</b> Electronic gear ration numerator	1~10000	1
<b>AE-03</b> Electronic gear ration denominator	1~10000	1
<b>AE-04</b> Positioning complete range setting	0~10000(Pulse)	5
<b>AE-05</b> Positioning complete delay time setting	0.00~10.00(s)	0.00
<b>AE-06</b> Position feedforward gain setting	0~655.35	0.00
<b>AE-07</b> Position loop gain setting	0.00~100.00	0.50
<b>AE-08</b> Position bias value setting	-2048~2048(Pulse)	0

- Feedback signal is needed to perform the position control.  
For more information, refer to the User's guide.

## Home search function setting

Code/Name	Range (unit)	Initial value
<b>AE-10</b> Stop position reference selection for Home search function	00(Parameter)/01(Option 1)/02(Option 2)/03(Option 3)/	09
<b>AE-11</b> Stop position of Home search function	0~4096	0
<b>AE-12</b> Speed reference of Home search function	0.00~120.00(Hz)	0.00
<b>AE-13</b> Direction of Home search function	00(Forward)/01(Reverse)	00

- Adjust the Home search function of the position control.  
For more information, refer to the User's guide.

## [AE-20]~[AE-62]

## Absolute position control

Code/Name	Range (unit)	Initial value
<b>AE-20</b> Position reference 0		0
<b>AE-22</b> Position reference 1		0
<b>AE-24</b> Position reference 2		0
<b>AE-26</b> Position reference 3		0
<b>AE-28</b> Position reference 4		0
<b>AE-30</b> Position reference 5		0
<b>AE-32</b> Position reference 6	When [AA123]≠03 -268435455~ +268435455(pulse)	0
<b>AE-34</b> Position reference 7		0
<b>AE-36</b> Position reference 8	When [AA123]=03 -1073741823~ +107374182(pulse)	0
<b>AE-38</b> Position reference 9		0
<b>AE-40</b> Position reference 10		0
<b>AE-42</b> Position reference 11		0
<b>AE-44</b> Position reference 12		0
<b>AE-46</b> Position reference 13		0
<b>AE-48</b> Position reference 14		0
<b>AE-50</b> Position reference 15		0
<b>AE-52</b> Position control range setting (forward)	When [AA123]≠03 0~+268435455(pulse)/ When [AA123]=03 0~+107374182(pulse)	0
<b>AE-54</b> Position control range setting (reverse)	When [AA123]≠03 -268435455~0(pulse)/ When [AA123]=03 -1073741823~0(pulse)	0
<b>AE-56</b> Position control mode selection	00(Limited)/01(Not limited)	00

- Sets the absolute position function.  
For more information, refer to the User's guide.

## Teach-in function

Code/Name	Range (unit)	Initial value
<b>AE-60</b> Teach-in function target selection	00~15(X00~X15)	00

- Set auto-learning position for the absolute position mode.  
For more information, refer to the User's guide.

## Enable position saving when power is cut off

Code/Name	Range (unit)	Initial value
<b>AE-61</b> Current Position saving at power off	00(Disable)/01(Enable)	00

- Saves the absolute position when the power supply is cut-off.  
For more information, refer to the User's guide.

## Pre-set position

Code/Name	Range (unit)	Initial value
<b>AE-62</b> Preset position data	When [AA123]≠03 -268435455~+268435455(pulse) When [AA123]=03 -1073741823~+107374182(pulse)	0

- In the absolute position mode sets the pre-set position.  
For more information, refer to the User's guide.

[AE-64]~[AE-76]

Positioning function adjustment

Code/Name	Range (unit)	Initial value
<b>AE-64</b> Deceleration stop distance calculation gain	50.00~200.00(%)	100.00
<b>AE-65</b> Deceleration stop distance calculation bias	0.00~655.35(%)	0.00
<b>AE-66</b> Speed Limit in APR control	0.00~100.00(%)	1.00
<b>AE-67</b> APR start speed	0.00~100.00(%)	0.20

- Adjustment of control operation for positioning control. For more information, refer to the user's guide.

Homing (Return to reference position)

Code/Name	Range (unit)	Initial value
<b>AE-70</b> Homing function selection	00(Low-speed)/ 01(High-Speed 1)/ 02(High-Speed 2)	00
<b>AE-71</b> Direction of homing function	00(Forward)/ 01(Reverse)	00
<b>AE-72</b> Low-speed of homing function	0.00~10.00(Hz)	0.00
<b>AE-73</b> High-Speed of homing function	0.00~590.00(Hz)	0.00

- Sets the Zero-return function for absolute position mode. For more information, refer to the user's guide.

[AF101]~[AF109]

DC braking (DB) function

Code/Name	Range (unit)	Initial value
<b>AF101</b> DC braking selection, 1st-motor	00(Disable)/01(Enable)/ 02(Frequency reference)	00
<b>AF102</b> Braking type selection, 1st-motor	00(DC braking)/ 01(Speed servo-lock)/ 02(Position servo-lock)	00
<b>AF103</b> DC braking frequency, 1st-motor	0.00~590.00(Hz)	0.00
<b>AF104</b> DC braking delay time, 1st-motor	0.00~5.00(s)	0.00
<b>AF105</b> DC braking force setting, 1st-motor	0~100(%)	30
<b>AF106</b> DC braking active time at stop, 1st-motor	0.00~60.00(s)	0.00
<b>AF107</b> DC braking operation method selection, 1st-motor	00(Edge)/ 01(Level)	01
<b>AF108</b> DC braking force at start, 1st-motor	0~100(%)	30
<b>AF109</b> DC braking active time at start, 1st-motor	0.00~60.00(s)	0.00

- DB at stop/start [AF101]=01 or DB at frequency reference [AF101]=02 can be selected.
- DC braking can be used if Intelligent input terminal 030[DB] is ON.
- In vector control with encoder, use the [AF102] Servo-lock function.

- Stop DB example (Braking force adjusted by AF105)

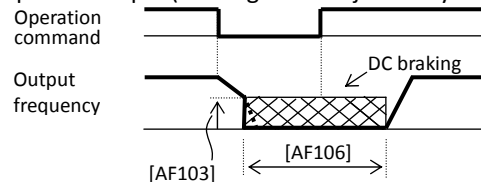

- Start DB example (Braking force adjusted by AF108)

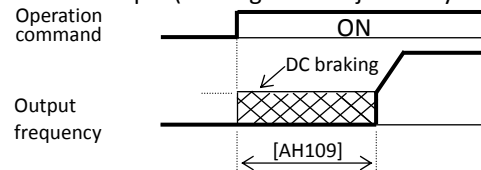

- Frequency reference DB example (Braking force adjusted by AF105)

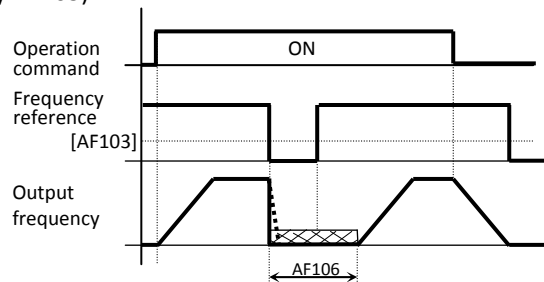

- When the DC braking time is set as 0.00(s), DC braking is not operational.

## [AF120]~[AF144]

## [AF150]~[AF254]

## Brake control function

Code/Name	Range (unit)	Initial value
<b>AF120</b> Contactor control enable, 1st-motor	00(Disable) 01(Enable: primary side) 02(Enable: secondary side)	00
<b>AF121</b> Run delay time, 1st-motor	0.00~2.00(s)	0.20
<b>AF122</b> Contactor off delay time, 1st-motor	0.00~2.00(s)	0.10
<b>AF123</b> Contactor answer back check time, 1st-motor	0.00~5.00(s)	0.10
<b>AF130</b> Brake control enable, 1st-motor	00(Disable)/ 01(Brake control 1: Common)/ 02(Brake control 1: Separate)/ 03(Brake control 2)	00
<b>AF131</b> Brake wait time for release, 1st-motor (Forward)	0.00~5.00(s)	0.00
<b>AF132</b> Brake wait time for Acc., 1st-motor (Forward)	0.00~5.00(s)	0.00
<b>AF133</b> Brake wait time for Stop, 1st-motor (Forward)	0.00~5.00(s)	0.00
<b>AF134</b> Brake wait time for confirmation, 1st-motor (Forward)	0.00~5.00(s)	0.00
<b>AF135</b> Brake release frequency, 1st-motor (Forward)	0.00~590.00(Hz)	0.00
<b>AF136</b> Brake release current, 1st-motor (Forward)	Inverter rated current ×(0.20~2.00)	*1)
<b>AF137</b> Brake frequency, 1st-motor (Forward)	0.00~590.00(Hz)	0.00
<b>AF138</b> Brake wait time for release, 1st-motor (Reverse)	0.00~5.00(s)	0.00
<b>AF139</b> Brake wait time for Acc., 1st-motor (Reverse)	0.00~5.00(s)	0.00
<b>AF140</b> Brake wait time for Stop, 1st-motor (Reverse)	0.00~5.00(s)	0.00
<b>AF141</b> Brake wait time for confirmation, 1st-motor (Reverse)	0.00~5.00(s)	0.00
<b>AF142</b> Brake release frequency, 1st-motor (Reverse)	0.00~590.00(Hz)	0.00
<b>AF143</b> Brake release current, 1st-motor (Reverse)	Inverter rated current ×(0.20~2.00)	*1)
<b>AF144</b> Brake frequency, 1st-motor (Reverse)	0.00~590.00(Hz)	0.00

\*1) Inverter rated current × 1.00.

Code/Name	Range (unit)	Initial value
<b>AF150</b> Brake open delay time, 1st-motor	0.00~2.00(s)	0.20
<b>AF151</b> Brake close delay time, 1st-motor	0.00~2.00(s)	0.20
<b>AF152</b> Brake check time, 1st-motor	0.00~5.00(s)	0.10
<b>AF153</b> Servo lock/ DC injection time at start, 1st-motor	0.00~10.00(s)	0.60
<b>AF154</b> Servo lock/ DC injection time at stop, 1st-motor	0.00~10.00(s)	0.60

• Operations settings of brake control.

For more information, refer to the User's guide.

**2nd motor** When Intelligent Input terminal 024[SET] is enabled.

Code/Name	Range (unit)	Initial value
<b>AF201</b> DC braking enable, 2nd-motor	Same as AF101	
<b>AF202</b> Braking type selection, 2nd-motor	Same as AF102	
<b>AF203</b> DC braking frequency, 1st-motor	Same as AF103	
<b>AF204</b> DC braking delay time, 2nd-motor	Same as AF104	
<b>AF205</b> DC braking force while stopping, 2nd-motor	Same as AF105	
<b>AF206</b> DC braking active time at stop, 2nd-motor	Same as AF106	
<b>AF207</b> DC braking trigger selection, 2nd-motor	Same as AF107	
<b>AF208</b> DC braking force while starting, 2nd-motor	Same as AF108	
<b>AF209</b> DC braking active time at start, 2nd-motor	Same as AF109	
<b>AF220</b> Contactor control enable, 2nd-motor	Same as AF120	
<b>AF221</b> Activation delay time, 2nd-motor	Same as AF121	
<b>AF222</b> Deactivation delay time, 2nd-motor	Same as AF122	
<b>AF223</b> Contactor check time, 2nd-motor	Same as AF123	
<b>AF230</b> Brake control enable, 2nd-motor	Same as AF130	
<b>AF231</b> Brake wait time for release, 2nd-motor (Forward)	Same as AF131	
<b>AF232</b> Brake wait time for Acc., 2nd-motor (Forward)	Same as AF132	
<b>AF233</b> Brake wait time for Stop, 2nd-motor (Forward)	Same as AF133	
<b>AF234</b> Brake wait time for confirmation, 2nd-motor (Forward)	Same as AF134	
<b>AF235</b> Brake release frequency, 2nd-motor (Forward)	Same as AF135	
<b>AF236</b> Brake release current, 2nd-motor (Forward)	Same as AF136	
<b>AF237</b> Brake frequency, 2nd-motor (Forward)	Same as AF137	
<b>AF238</b> Brake wait time for release, 2nd-motor (Reverse)	Same as AF138	
<b>AF239</b> Brake wait time for Acc., 2nd-motor (Reverse)	Same as AF139	
<b>AF240</b> Brake wait time for Stop, 2nd-motor (Reverse)	Same as AF140	
<b>AF241</b> Brake wait time for confirmation, 2nd-motor (Reverse)	Same as AF141	
<b>AF242</b> Brake release frequency, 2nd-motor (Reverse)	Same as AF142	
<b>AF243</b> Brake release current, 2nd-motor (Reverse)	Same as AF143	
<b>AF244</b> Braking frequency, 2nd-motor (Reverse side)	Same as AF144	
<b>AF250</b> Brake open delay time, 2nd-motor	Same as AF150	
<b>AF251</b> Brake close delay time, 2nd-motor	Same as AF151	
<b>AF252</b> Brake check time, 2nd-motor	Same as AF152	
<b>AF253</b> Servo lock/DC injection time at start, 2nd-motor	Same as AF153	
<b>AF254</b> Servo lock/DC injection time at stop, 2nd-motor	Same as AF154	

[AG101]~[AG113]

Resonant frequency avoidance (Jump)

Code/Name	Range (unit)	Initial value
<b>AG101</b> Jump frequency 1, 1st-motor	0.00~590.00(Hz)	0.00
<b>AG102</b> Jump frequency width 1, 1st-motor	0.00~10.00(Hz)	0.00
<b>AG103</b> Jump frequency 2, 1st-motor	0.00~590.00(Hz)	0.00
<b>AG104</b> Jump frequency width 2, 1st-motor	0.00~10.00(Hz)	0.00
<b>AG105</b> Jump frequency 3, 1st-motor	0.00~590.00(Hz)	0.00
<b>AG106</b> Jump frequency width 3, 1st-motor	0.00~10.00(Hz)	0.00

- Prevents the passing of the output frequency in a resonant point. Output frequency changes continuously.

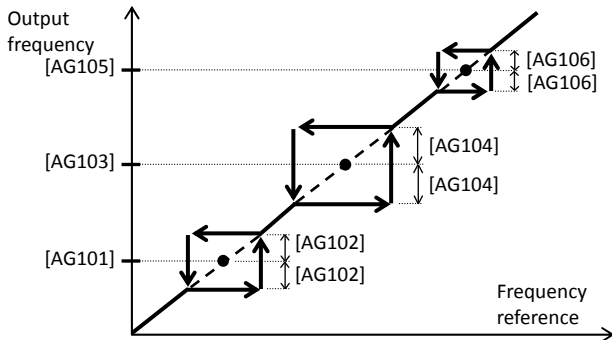

Motor Acc/Decel dwell (Hold)

Code/Name	Range (unit)	Initial value
<b>AG110</b> Acceleration stop frequency setting, 1st-motor	0.00~590.00(Hz)	0.00
<b>AG111</b> Acceleration stop time setting, 1st-motor	0.00~60.00(s)	0.00
<b>AG112</b> Deceleration stop frequency setting, 1st-motor	0.00~590.00(Hz)	0.00
<b>AG113</b> Deceleration stop time setting, 1st-motor	0.00~60.00(s)	0.00

- By using the dwell function when the inertial load is considerable, if the set frequency is reached in the set time the Acc/Decel of the frequency will be stopped.
- If the Intelligent input terminal function 100[HLD] is in ON state, the acceleration and deceleration will be stopped (Hold activation).

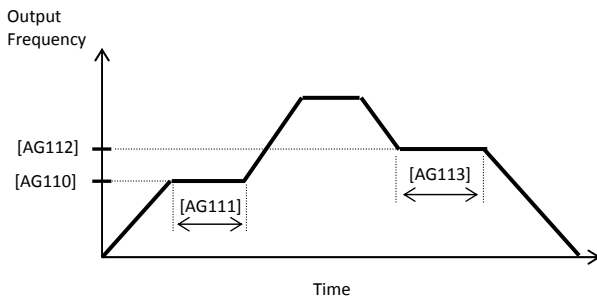

[AG-20]~[AG213]

Jogging function

Code/Name	Range (unit)	Initial value
<b>AG-20</b> Jogging frequency	0.00~10.00(Hz)	0.00
<b>AG-21</b> Jogging stop selection	00(free-running, disabled during operation) 01(decel/stop, disabled during operation) 02(DC braking, disabled during operation) 03(free-running, enabled during operation) 04(decel/stop, enabled during operation) 05(DC braking, enabled during operation)	00

- When Input terminal [JG] is active (ON), if the operation command is given the jogging frequency is outputted. The frequency and stop method can be set when performing jogging motion.

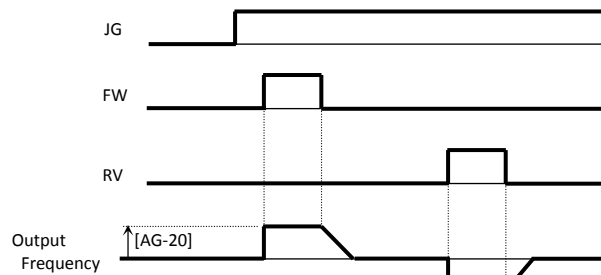

2nd motor When Intelligent Input terminal 024[SET] is enabled.

Code/Name	Range (unit)	Initial value
<b>AG201</b> Jump frequency 1, 2nd-motor	Same as AG101	
<b>AG202</b> Jump frequency width 1, 2nd-motor	Same as AG102	
<b>AG203</b> Jump frequency 2, 2nd-motor	Same as AG103	
<b>AG204</b> Jump frequency width 2, 2nd-motor	Same as AG104	
<b>AG205</b> Jump frequency 3, 2nd-motor	Same as AG105	
<b>AG206</b> Jump frequency width 3, 2nd-motor	Same as AG106	
<b>AG210</b> Acceleration stop frequency setting, 2nd-motor	Same as AG110	
<b>AG211</b> Acceleration stop time setting 2nd-motor	Same as AG111	
<b>AG212</b> Deceleration stop frequency setting, 2nd-motor	Same as AG112	
<b>AG213</b> Deceleration stop time setting,, 2nd-motor	Same as AG113	

[AH-01]~[AH-06]

**PID1 function**

Code/Name	Range (unit)	Initial value
<b>AH-01</b> PID1 enable	00(Disable)/ 01(Enable)/ 02(Enable:inverted output)	00

- Validates the PID1 operation.
- If [AH-01]=01 when the PID output reaches negative value, the PID output is limited to 0.
- If [AH-01]=02 when the PID output reaches negative value, the PID output lets out an inverted output.
- When the PID output is negative, the motor will rotate in the contrary direction.
- If [PID] terminal is ON, the PID control is disabled and the [PID] target value becomes the frequency reference.

Code/Name	Range (unit)	Initial value
<b>AH-02</b> PID1 deviation inverse	00(Disable)/ 01(Enable)	00

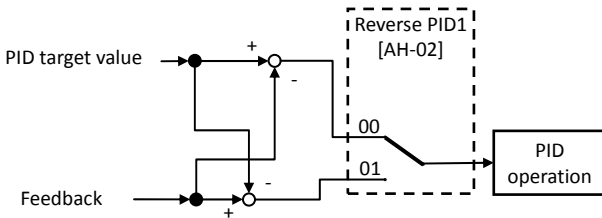

Code/Name	Range (unit)	Initial value
<b>AH-03</b> unit selection for PID1	<unit table> at the end of the document can be consulted	03
<b>AH-04</b> PID1 adjustment (0%)	-10000~10000	0
<b>AH-05</b> PID1 adjustment (100%)	-10000~10000	10000
<b>AH-06</b> PID1 Adjustment (decimal point)	0~4	2

- The unit and display data related to the output of the PID control can be changed.

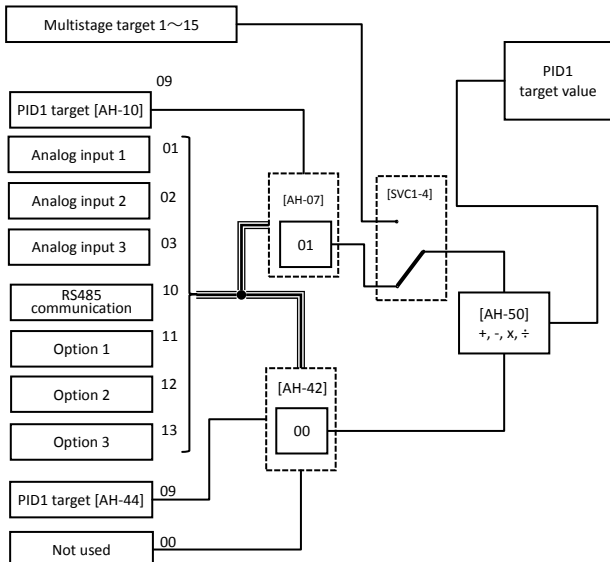

[AH-07]~[AH-50]

Code/Name	Range (unit)	Initial value
<b>AH-07</b> Target value 1 reference selection for PID1	00~06/09~15 *1)	09
<b>AH-10</b> PID1 target value-1	0.00~100.00(%) *1)	0.00
<b>AH-12</b> PID1 Multistage set point 1		0.00
<b>AH-14</b> PID1 Multistage set point 2		0.00
<b>AH-16</b> PID1 Multistage set point 3		0.00
<b>AH-18</b> PID1 Multistage set point 4		0.00
<b>AH-20</b> PID1 Multistage set point 5		0.00
<b>AH-22</b> PID1 Multistage set point 6		0.00
<b>AH-24</b> PID1 Multistage set point 7		0.00
<b>AH-26</b> PID1 Multistage set point 8		0.00
<b>AH-28</b> PID1 Multistage set point 9		0.00
<b>AH-30</b> PID1 Multistage set point 10		0.00
<b>AH-32</b> PID1 Multistage set point 11		0.00
<b>AH-34</b> PID1 Multistage set point 12		0.00
<b>AH-36</b> PID1 Multistage set point 13		0.00
<b>AH-38</b> PID1 Multistage set point 14		0.00
<b>AH-40</b> PID1 Multistage set point 15	0.00	
<b>AH-42</b> Input source selection of Set point 3 for PID1	00~13*2)	00
<b>AH-44</b> PID1 target value-2	0.00~100.00(%)	0.00
<b>AH-46</b> Target value 3 reference selection for PID1	00~13*2)	0.00
<b>AH-48</b> PID1 target value-3	0.00~100.00(%)	0.00
<b>AH-50</b> Math operator selection of PID1 target value 1	01(Addition) 02(Subtraction) 03(Multiplication) 04(Division)	01

\*1) Display range can be set by [AH-04], [AH-05] and [AH-06].

\*2) 00(Disable)/01(Ai1 terminal)/02(Ai2 terminal)/03(Ai3 terminal)/07(Parameter)/08(RS485)/14(Pulse train input:main)/

- For PID1 target value, two targets are selected, target value 1 and target value 2, the result of the operation carried out between these two targets constitutes the PID1 target value.
- If Input terminal function 051[SVCl]~054[SVc4] are used, the PID target value can be changed for the Multistage.

Multistage value	SVc4	SVc3	SVc2	SVc1
Target value 0	OFF	OFF	OFF	OFF
Target value 1	OFF	OFF	OFF	ON
Target value 2	OFF	OFF	ON	OFF
Target value 3	OFF	OFF	ON	ON
Target value 4	OFF	ON	OFF	OFF
Target value 5	OFF	ON	OFF	ON
Target value 6	OFF	ON	ON	OFF
Target value 7	OFF	ON	ON	ON
Target value 8	ON	OFF	OFF	OFF
Target value 9	ON	OFF	OFF	ON
Target value 10	ON	OFF	ON	OFF
Target value 11	ON	OFF	ON	ON
Target value 12	ON	ON	OFF	OFF
Target value 13	ON	ON	OFF	ON
Target value 14	ON	ON	ON	OFF
Target value 15	ON	ON	ON	ON

[AH-51]~[AH-54]

Code/Name	Range (unit)	Initial value
<b>AH-51</b> Input source selection of process data 1 for PID1	00~06/08~13 *1)	01
<b>AH-52</b> Input source selection of process data 2 for PID1		00
<b>AH-53</b> Input source selection of process data 3 for PID1		00
<b>AH-54</b> Calculation symbol selection of Process data for PID1	01(Addition)/ 02(Subtraction)/ 03(Multiplication)/ 04(Division) 05(Square Root FB1) 06(Square Root FB2) 07(Square Root FB1-FB2) 08(Average of three inputs) 09(Minimum of three inputs) 10(Maximum of three inputs)	01

\*1)00(Not used)/01(Ai1 terminal)/02(Ai2 terminal)/03(Ai3 terminal)/04(Ai4 input)/05(Ai5 input)/06(Ai6 input)  
08(RS485)/ 09(Option 1)/10(Option 2)  
11(Option 3)/12(Pulse train input:main)/13(Pulse train input:option)

- For PID1 feedback, two targets are selected, feedback data 1 and feedback data 2, the result of the operation carried out between these two constitutes the PID1 feedback value.

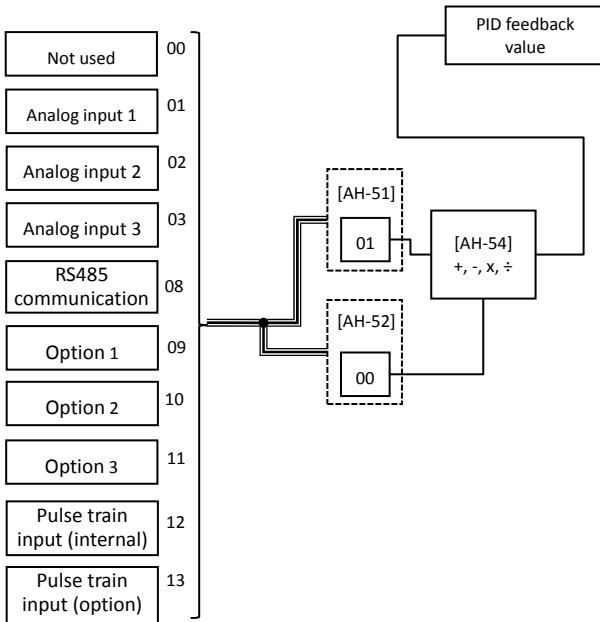

[AH-60]~[AH-70]

Code/Name	Range (unit)	Initial value
<b>AH-60</b> PID1 gain change method selection	00(Constant gain [1])/01([PRO] terminal)	00
<b>AH-61</b> PID1 proportional gain 1	0.0~100.0	1.0
<b>AH-62</b> PID1 integral time constant 1	0.0~3600.0(s)	1.0
<b>AH-63</b> PID1 derivative gain 1	0.0~100.0(s)	0.0
<b>AH-64</b> PID1 proportional gain 2	0.0~100.0	0.0
<b>AH-65</b> PID1 integral time constant 2	0.0~3600.0(s)	0.0
<b>AH-66</b> PID1 derivative gain 2	0.0~100.0(s)	0.0
<b>AH-67</b> PID1 gain change time	0~10000(ms)	100

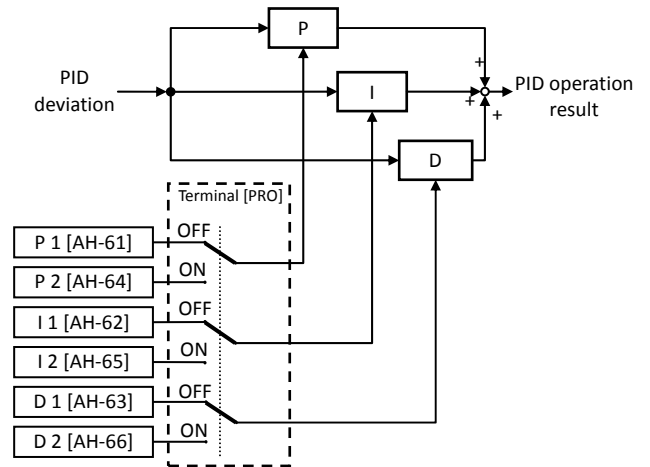

- If [PIDC] terminal is active (ON), the value of the integral constant is purged. If done while operating, the operation can become instable/insecure.
- With [PRO] terminal, the gain can be changed. If the state is OFF, Gain 1 is used, if the state is ON, Gain 2 is used.

Code/Name	Range (unit)	Initial value
<b>AH-70</b> PID1 feedforward selection	00~03 *2)	00

\*2) 00(Not used)/01(Ai1 terminal)/02(Ai2 terminal)/03(Ai3 terminal)

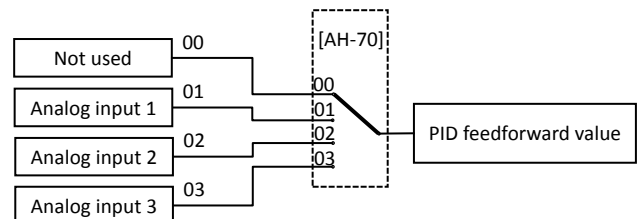

- To perform the PID feedforward control, an input is selected.

[AH-71]~[AH-74]

Code/Name	Range (unit)	Initial value
<b>AH-71</b> PID1 output variable	0.00~100.00(%)	0.00

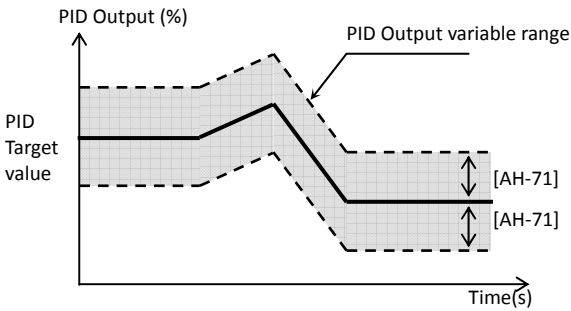

- Limits the output range of the PID. If [AH-71]=0.00 the limit is disabled.

Code/Name	Range (unit)	Initial value
<b>AH-72</b> PID1 deviation over level	0.00~100.00(%)	3.00

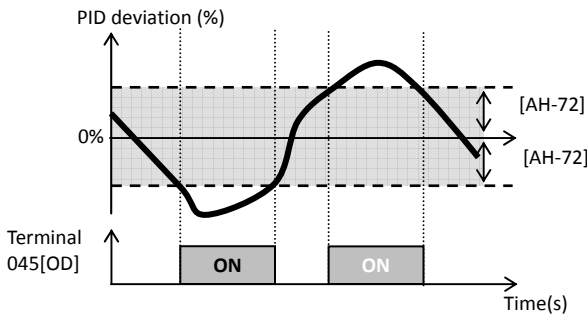

- When the PID deviation pass over the  $\pm$ [AH-72], the output terminal function 045[OD] is activated.

Code/Name	Range (unit)	Initial value
<b>AH-73</b> PID feedback compare signal turn-off level	0.00~100.00(%)	100.00
<b>AH-74</b> PID feedback compare signal turn-on level	0.00~100.00(%)	0.00

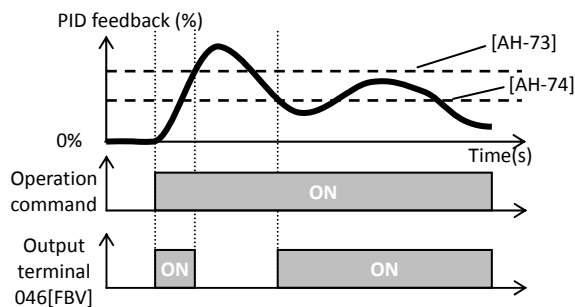

- If the PID feedback cross over the [AH-73] level, the output terminal function 046[FBV] is deactivated (OFF). If it crosses under the [AH-74] level, is activated (ON).

[AH-75]~[AH-92]

Code/Name	Range (unit)	Initial value
<b>AH-75</b> PID soft start function enable	00(Disable)/01(Enable)	00
<b>AH-76</b> PID soft start target level	0.00~100.00(%)	100.00
<b>AH-78</b> Acceleration time setting for PID soft start	0.00~3600.00(s)	30.00
<b>AH-80</b> PID soft start time	0.00~100.00(s)	0.00
<b>AH-81</b> PID soft start error detection enable	00(Disable)/01(Enable: Error)/02(Enable: Warning)	00
<b>AH-76</b> PID soft start target level	0.00~100.00(%)	100.00

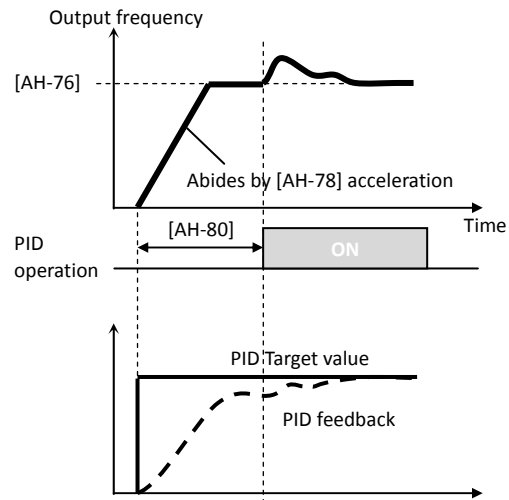

- For a shockless operation, base frequency  $\times$  [AH-76] is made the target value, with the [AH-80] output time.
- In the case of a soft start, the acceleration time can be set with [AH-78].

Code/Name	Range (unit)	Initial value
<b>AH-85</b> PID sleep trigger selection	00(Disable)/01(Low output)/02([SLEP] terminal)	00
<b>AH-86</b> PID sleep start level	0.00~590.00(Hz)	0.00
<b>AH-87</b> PID sleep active time	0.0~100.0(s)	0.0
<b>AH-88</b> Setpoint boost before PID sleep enable	00(Disable)/01(Enable)	00
<b>AH-89</b> Setpoint boost time	0.00~100.00(s)	0.00
<b>AH-90</b> Setpoint boost value	0.00~100.00(%)	0.00
<b>AH-91</b> Minimum RUN time before PID sleep	0.00~100.00(s)	0.00
<b>AH-92</b> Minimum active time of PID sleep	0.00~100.00(s)	0.00

- The PID sleep function temporarily reduces the PID output, achieving an energy saving state.



[AH-93]~[AH-96]

Code/Name	Range (unit)	Initial value
<b>AH-93</b> PID sleep trigger selection	01(Deviation)/ 02(Falling feedback)/ 03([WAKE] terminal)	01
<b>AH-94</b> PID wake-up start level	0.00~100.00(%)	0.00
<b>AH-95</b> PID wake-up start time	0.00~100.00(s)	0.00
<b>AH-96</b> PID wake-up start deviation value	0.00~100.00(%)	0.00

• Operation example of the sleep function.

Example 1) [AH-85]=01(Low output)  
[AH-93]=01(Deviation)

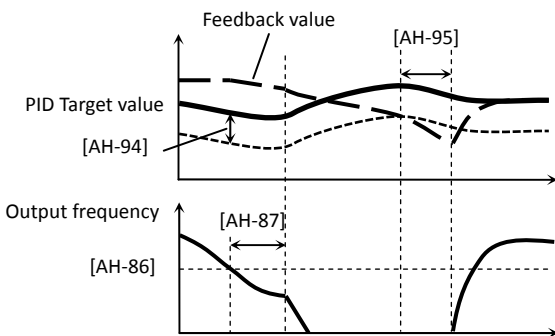

Example 2) [AH-85]=01(Low output)  
[AH-93]=02(Low feedback)

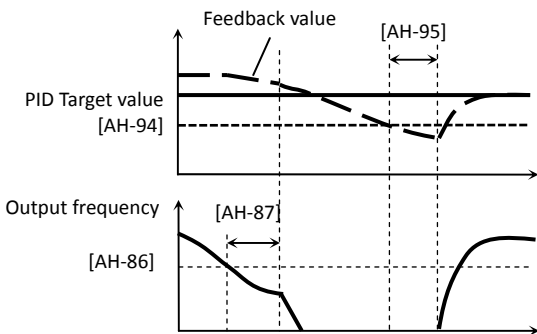

Example 3) [AH-85]=02([SLEP] terminal)  
[AH-93]=03([WAKE] terminal)

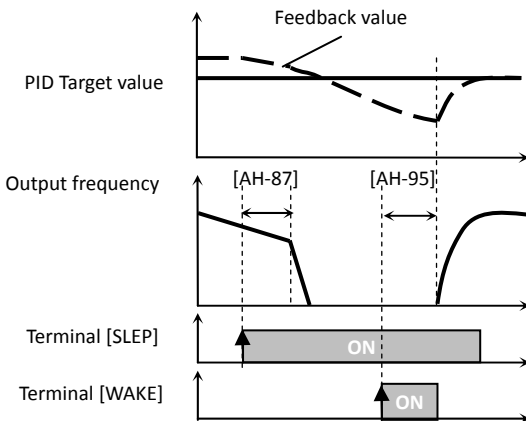

[AJ-01]~[AJ-10]

PID2 function

Code/Name	Range (unit)	Initial value
<b>AJ-01</b> PID2 enable	00(Disable)/01(Enable)/ 02(Enable:inverted output)	00

- Validates the PID2 operation.
- If [AJ-01]=01 when the PID output reaches a negative value, the PID output is limited to 0.
- If [AJ-01]=02 when the PID output reaches a negative value, the PID output lets out an inverted output.
- By activating the [PID2] terminal, the PID2 output becomes 0.

Code/Name	Range (unit)	Initial value
<b>AJ-02</b> PID2 deviation inverse	00(Disable)/ 01(Enable)	00

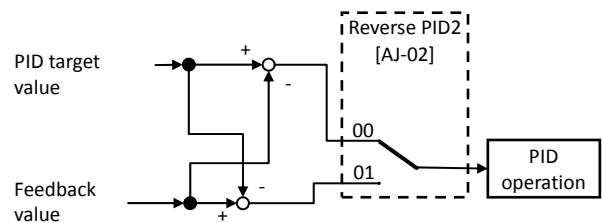

• PID2 deviation can be reversed.

Code/Name	Range (unit)	Initial value
<b>AJ-03</b> PID2 unit selection	<unit table> at the end of the document can be consulted	03
<b>AJ-04</b> PID2 scale adjustment (0%)	-10000~10000	0
<b>AJ-05</b> PID2 scale adjustment (100%)	-10000~10000	10000
<b>AJ-06</b> PID2 scale adjustment (decimal point)	0~4	2

• You can switch the display data and the display unit involved in the output of the PID control by the calculation.

Code/Name	Range (unit)	Initial value
<b>AJ-07</b> Input source selection of set-point for PID2	00~08, 12, 13, 15 *1)	07
<b>AJ-10</b> Set point setting for PID2	-100.00~100.00(%)	0.00

• When PID2 target value input is selected, if the selected is the parameter setting, [AJ-10] gets enabled.

Code/Name	Range (unit)	Initial value
<b>AJ-12</b> Feedback data reference selection for PID2	00~08, 12, 13, 15 *1)	02

• Selects the PID2 feedback reference.

\*1)00(Not used)/01(Ai1 terminal)/02(Ai2 terminal)/03(Ai3 terminal)/04(Ai4 terminal)/05(Ai5 terminal)/06(Ai6 terminal)/07(Parameter)/08(RS485)/12(Pulse train input: main)/13(Pulse train input: option)/15(PID1 output)

[AJ-13]~[AJ-19]

Code/Name	Range (unit)	Initial value
<b>AJ-13</b> PID2 proportional gain	0.0~100.0	1.0
<b>AJ-14</b> PID2 integral time constant	0.0~3600.0(s)	1.0
<b>AJ-15</b> PID2 derivative gain	0.0~100.0(s)	0.0

- Sets the PID2 gain.
- If [PIDC] terminal is active (ON), the value of the integral constant is purged. If done while operating, the operation can become instable/insecure.

Code/Name	Range (unit)	Initial value
<b>AJ-16</b> PID2 output variable	0.00~100.00(%)	0.00

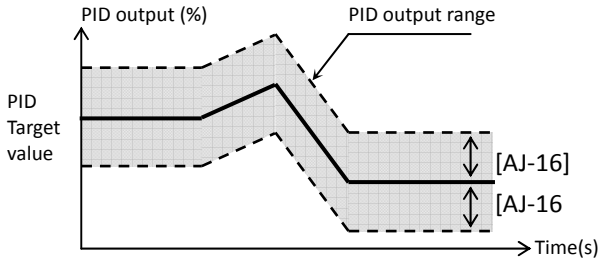

- Limits the output range of the PID. If [AJ-16]=0.00 the limit is disabled.

Code/Name	Range (unit)	Initial value
<b>AJ-17</b> PID2 deviation over level	0.00~100.00(%)	3.00

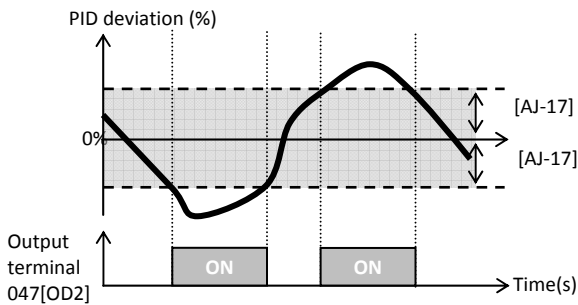

- When the PID deviation pass over  $\pm$ [AJ-17], the output terminal function 047[OD2] is activated.

Code/Name	Range (unit)	Initial value
<b>AJ-18</b> PID2 feedback compare signal turn-off level	0.00~100.00(%)	100.00
<b>AJ-19</b> PID2 feedback compare signal turn-on level	0.00~100.00(%)	0.00

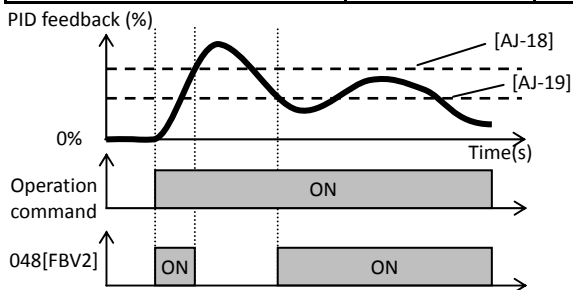

- When the PID feedback cross over the [AJ-18] level, the output terminal function 048[FBV2] is deactivated (OFF). If it crosses under the [AJ-19] level, is activated (ON).

[AJ-21]~[AJ-30]

PID3 function

Code/Name	Range (unit)	Initial value
<b>AJ-21</b> PID3 enable	00(Disable)/01(Enable)/02(Enable:inverted output)	00

- Validates the PID3 operation.
- If [AJ-21]=01 when the PID output reaches a negative value, the PID output is limited to 0.
- If [AJ-21]=02 when the PID output reaches a negative value, the PID output lets out an inverted output.
- By activating the [PID3] terminal, the PID3 output becomes 0.

Code/Name	Range (unit)	Initial value
<b>AJ-22</b> PID3 deviation inverse	00(Disable)/01(Enable)	00

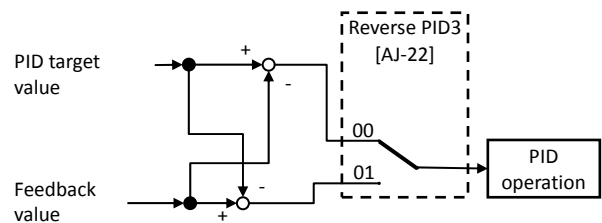

- PID3 deviation can be reversed.

Code/Name	Range (unit)	Initial value
<b>AJ-23</b> PID3 unit selection	<unit table> at the end of the document can be consulted	03
<b>AJ-24</b> PID3 scale adjustment (0%)	-10000~10000	0
<b>AJ-25</b> PID3 scale adjustment (100%)	-10000~10000	10000
<b>AJ-26</b> PID3 scale adjustment (decimal point)	0~4	2

- You can switch the display data and the display unit involved in the output of the PID control by the calculation.

Code/Name	Range (unit)	Initial value
<b>AJ-27</b> Input source selection of set-point for PID3	00~08, 12, 13, 15 *1)	07
<b>AJ-30</b> set point setting for PID3	-100.00~100.00(%)	0.00

- When PID3 target value input is selected, if the selected is the parameter setting, [AJ-30] gets enabled.

Code/Name	Range (unit)	Initial value
<b>AJ-32</b> input source selection of process data for PID3	00~08, 12, 13, 15 *1)	02

- Selects the PID3 feedback reference.

\*1)00(Not used)/01(Ai1 terminal)/02(Ai2 terminal)/03(Ai3 terminal)/04(Ai4 terminal)/05(Ai5 terminal)/06(Ai6 terminal)/07(Parameter)/08(RS485)/ 12(Pulse train input: main)/ 13(Pulse train input: option)/15(PID1 output)

[AJ-33]~[AJ-39]

Code/Name	Range (unit)	Initial value
<b>AJ-33</b> PID3 proportional gain	0.0~100.0	1.0
<b>AJ-34</b> PID3 integral time constant	0.0~3600.0(s)	1.0
<b>AJ-35</b> PID3 derivative gain	0.0~100.0(s)	0.0

- Sets the PID3 gain.
- If [PIDC] terminal is active (ON), the value of the integral constant is purged. If done while operating, the operation can become instable/insecure.

Code/Name	Range (unit)	Initial value
<b>AJ-36</b> PID3 output variable	0.00~100.00(%)	0.00

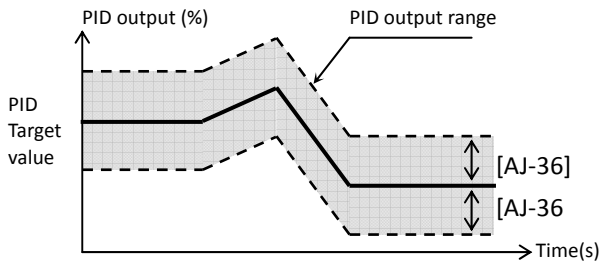

- Limits the output range of the PID. If [AJ-36]=0.00 the limit is disabled.

Code/Name	Range (unit)	Initial value
<b>AJ-37</b> PID3 deviation over level	0.00~100.00(%)	3.00

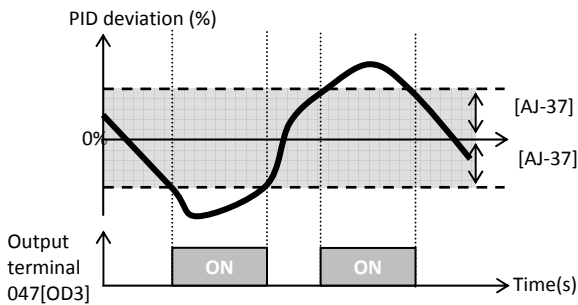

- When the PID deviation pass over  $\pm$ [AJ-37], the output terminal function 089[OD3] is activated.

Code/Name	Range (unit)	Initial value
<b>AJ-38</b> PID3 feedback compare signal turn-off level	0.00~100.00(%)	100.00
<b>AJ-39</b> PID3 feedback compare signal turn-on level	0.00~100.00(%)	0.00

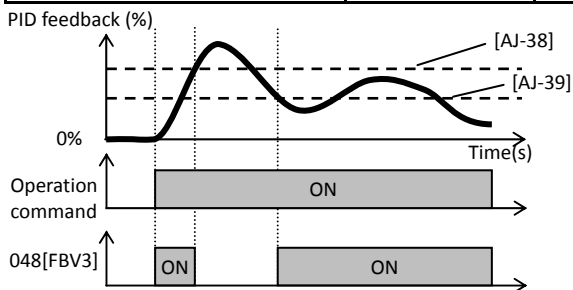

- When the PID feedback cross over the [AJ-18] level, the output terminal function 090[FBV3] is deactivated (OFF). If it crosses under the [AJ-39] level, is activated (ON).

[AJ-41]~[AJ-50]

PID3 function

Code/Name	Range (unit)	Initial value
<b>AJ-41</b> PID4 enable	00(Disable)/01(Enable)/02(Enable:inverted output)	00

- Validates the PID4 operation.
- If [AJ-41]=01 when the PID output reaches a negative value, the PID output is limited to 0.
- If [AJ-41]=02 when the PID output reaches a negative value, the PID output lets out an inverted output.
- By activating the [PID4] terminal, the PID4 output becomes 0.

Code/Name	Range (unit)	Initial value
<b>AJ-42</b> PID4 deviation inverse	00(Disable)/01(Enable)	00

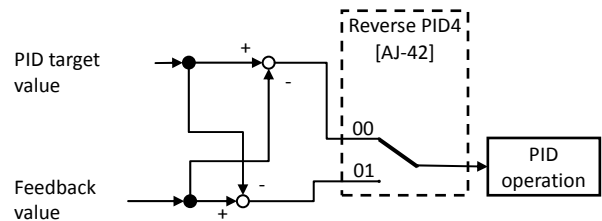

- PID4 deviation can be reversed.

Code/Name	Range (unit)	Initial value
<b>AJ-43</b> PID4 unit selection	<unit table> at the end of the document can be consulted	03
<b>AJ-44</b> PID4 scale adjustment (0%)	-10000~10000	0
<b>AJ-45</b> PID4 scale adjustment (100%)	-10000~10000	10000
<b>AJ-46</b> PID4 scale adjustment (decimal point)	0~4	2

- You can switch the display data and the display unit involved in the output of the PID control by the calculation.

Code/Name	Range (unit)	Initial value
<b>AJ-47</b> Input source selection of process data for PID4	00~08, 12, 13, 15 *1)	07
<b>AJ-50</b> Set point setting for PID4	-100.00~100.00(%)	0.00

- When PID4 target value input is selected, if the selected is the parameter setting, [AJ-50] gets enabled.

Code/Name	Range (unit)	Initial value
<b>AJ-52</b> Feedback data reference selection for PID4	00~08, 12, 13, 15 *1)	02

- Selects the PID4 feedback reference.
- \*1)00(Not used)/01(Ai1 terminal)/02(Ai2 terminal)/03(Ai3 terminal)/04(Ai4 terminal)/05(Ai5 terminal)/06(Ai6 terminal)/07(Parameter)/08(RS485)/ 12(Pulse train input: main)/ 13(Pulse train input: option)/15(PID1 output)

[AJ-53]~[AJ-59]

Code/Name	Range (unit)	Initial value
<b>AJ-53</b> PID4 proportional gain	0.0~100.0	1.0
<b>AJ-54</b> PID4 integral time constant	0.0~3600.0(s)	1.0
<b>AJ-55</b> PID4 derivative gain	0.0~100.0(s)	0.0

- Sets the PID4 gain.
- If [PIDC] terminal is active (ON), the value of the integral constant is purged. If done while operating, the operation can become instable/insecure.

Code/Name	Range (unit)	Initial value
<b>AJ-56</b> PID4 output variable	0.00~100.00(%)	0.00

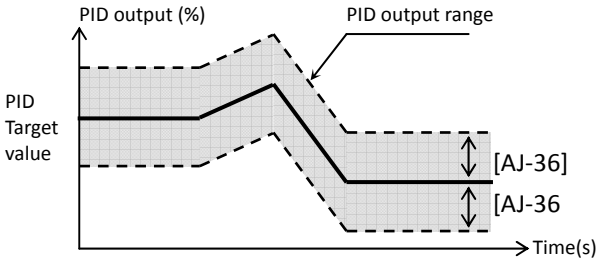

- Limits the output range of the PID. If [AJ-56]=0.00 the limit is disabled.

Code/Name	Range (unit)	Initial value
<b>AJ-57</b> PID4 deviation over level	0.00~100.00(%)	3.00

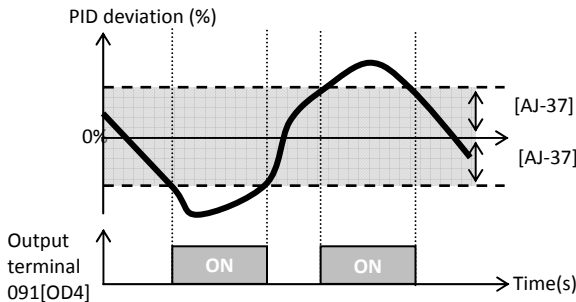

- When the PID deviation pass over  $\pm$ [AJ-57], the output terminal function 091[OD4] is activated.

Code/Name	Range (unit)	Initial value
<b>AJ-58</b> PID4 feedback compare signal turn-off level	0.00~100.00(%)	100.00
<b>AJ-59</b> PID4 feedback compare signal turn-on level	0.00~100.00(%)	0.00

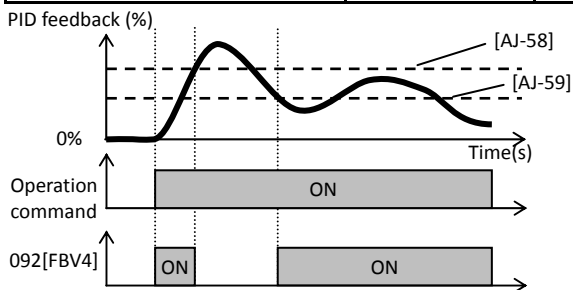

- When the PID feedback cross over the [AJ-58] level, the output terminal function 092[FBV4] is deactivated (OFF). If it crosses under the [AJ-59] level, is activated (ON).

[bA102]~[bA115]

Parameter mode (b code)

Frequency limit

Code/Name	Range (unit)	Initial value
<b>bA102</b> Frequency upper limit, 1st-motor	0.00~590.00(Hz)	0.00
<b>bA103</b> Frequency lower limit, 1st-motor	0.00~590.00(Hz)	0.00

- Sets upper and lower limits of the frequency.

Torque limit

Code/Name	Range (unit)	Initial value
<b>bA110</b> Torque limit selection, 1st-motor	01~03/ 07, 08 *1)	27
<b>bA111</b> Torque limiting parameter mode selection, 1st-motor	00(4 quadrants)/ 01([TRQ] terminal)	00
<b>bA112</b> Torque limit 1 (Forward driving), 1st-motor	0.0~500.0(%)	120.0(%)
<b>bA113</b> Torque limit 2 (Reverse regenerative), 1st-motor	0.0~500.0(%)	120.0(%)
<b>bA114</b> Torque limit 3 (Reverse driving), 1st-motor	0.0~500.0(%)	120.0(%)
<b>bA115</b> Torque limit (4) (forward-regenerating in 4-quadrant mode), 1st-motor	0.0~500.0(%)	120.0(%)
<b>bA116</b> Torque limit LADSTOP selection, 1st-motor	00(Disable)/ 01(Enable)	00

\*1) 01(Ai1 terminal)/02(Ai2 terminal)/03(Ai3 terminal)/07(Parameter)/08(RS485)

- In the case of vector control (With sensor – Sensorless – 0Hz) the torque limit function can limit the motor output torque.

[bA120]~[bA128]

Overcurrent suppression function setting

Code/Name	Range (unit)	Initial value
<b>bA120</b> Overcurrent suppression enable, 1st-motor	00(Disable)/01(Enable)	00
<b>bA121</b> Overcurrent suppression level, 1st-motor	Inverter ND rated current×(0.20~2.00)	*1)

\*1) Inverter ND rated current×1.80

- Overcurrent can be suppressed, but in that case torque drop can occur. Disable it in cases such as cranes.

Overload restriction function settings

Code/Name	Range (unit)	Initial value
<b>bA122</b> Overload restriction 1 enable, 1st-motor	00(Disable)/01(Enable during Acc. and constant speed)/02(Constant speed only)/03(Enable during Acc. and constant speed-Acc. during regeneration)	01
<b>bA123</b> Overload restriction 1 level, 1st-motor	Inverter rated current ×(0.20~2.00)	*2)
<b>bA124</b> Overload restriction 1 deceleration time, 1st-motor	0.10~3600.00(s)	1.00
<b>bA126</b> Overload restriction 2 enable, 1st-motor	00(Disable)/01(Enable during Acc. and constant speed)/02(Constant speed only)/03(Enable during Acc. and constant speed - Increase frequency during regeneration)	00
<b>bA127</b> Overload restriction 2 level, 1st-motor	Inverter rated current ×(0.20~2.00)	*2)
<b>bA128</b> Overload restriction 2 deceleration time, 1st-motor	0.10~3600.00(s)	1.00

\*2) Inverter rated current×1.50

- When the current is increased, the overload restriction function reduces the current automatically by lowering the frequency.

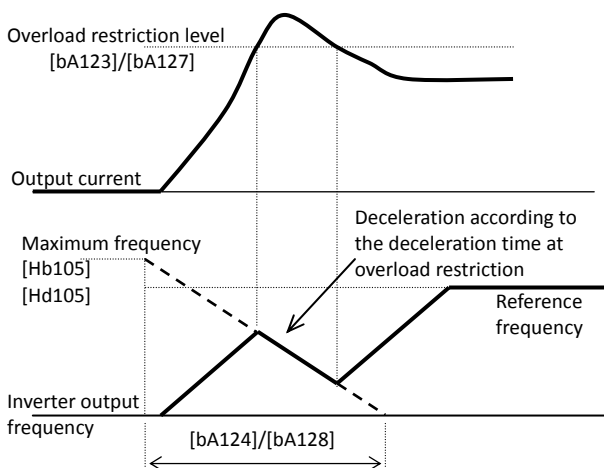

- Using [OLR] function state, the overload restriction 1 (OFF) and overload restriction 2 (ON) can be used.

[bA-30]~[bA145]

Deceleration / stop at power loss (Non-stop)

Code/Name	Range (unit)	Initial value
<b>bA-30</b> Selection of deceleration/stop in the event of a power loss	00(Disable)/01(Decel. stop)/02(Decel. stop: with resume)/03(Decel. stop: return to origin)	00
<b>bA-31</b> DC voltage trigger level during power loss	(200V class) 0.0~400.0(Vdc) (400V class) 0.0~800.0(Vdc)	(200V class) 220.0 (400V class) 440.0
<b>bA-32</b> Overvoltage threshold during power loss	(200V class) 0.0~400.0(Vdc) (400V class) 0.0~800.0(Vdc)	(200V class) 360.0 (400V class) 720.0
<b>bA-34</b> Deceleration time during power loss	0.01~3600.00(s)	1.00
<b>bA-36</b> Initial output frequency decrease during power loss	0.00~10.00(Hz)	0.00
<b>bA-37</b> Proportional gain for operation at power loss	0.00~2.55	0.20
<b>bA-38</b> Integral time for operation at power loss	0.000~65.535(s)	0.100

- If the DC voltage of the main circuit is lower than the level of [bA-31], the inverter decelerates to create a regenerative state.
- When [bA-30]=01, if the DC voltage drops, deceleration starts from the value of the actual frequency command to the [bA-36], according to the deceleration time [bA-34]. Once the DC voltage exceeds the [bA-32], the deceleration is temporally stopped.
- When [bA-30]=02/03, if the DC voltage drops below DC target level setting [bA-32], the output frequency is decreased by PI control to put in regenerative mode and the DC voltage is maintained at [bA-32] target level.

Overvoltage suppression - deceleration

Code/Name	Range (unit)	Initial value
<b>bA140</b> Overvoltage suppression enable, 1st-motor	00(Disable)/01(DC, constant decel.)/02(Enable acceleration)/03(Enable Acc. at constant speed & decel.)	00
<b>bA141</b> Overvoltage suppression level, 1st-motor	(200V class) 330.0~390.0(Vdc) (400V class) 660.0~780.0(Vdc)	(200V class) 380 (400V class) 760
<b>bA142</b> Overvoltage suppression action time, 1st-motor	0.00~3600.00(s)	1.00
<b>bA144</b> Overvoltage suppression proportional gain, 1st-motor	0.00~2.55	0.50
<b>bA145</b> Overvoltage suppression integral time, 1st-motor	0.000~65.535(s)	0.060

- When [bA140]=01, the deceleration time is increased until stop so the DC voltage do not cross over the [bA141] level.
- When [bA140]=02/03, accelerates temporally so the DC voltage do not cross over [bA141] level.

[bA146]~[bA149] [bA-60]~[bA-63]

**Overvoltage suppression - Over-excitation**

Code/Name	Range (unit)	Initial value
<b>bA146</b> Over magnetization function selection (V/f), 1st-motor	00(Disable)/01(Always ON)/02(Only at deceleration)/03(Operation at set level)/04(Only at Decel. and level)	02
<b>bA147</b> Time constant of over-magnetisation output filter (V/f), 1st-motor	0.00~1.00(s)	0.30
<b>bA148</b> Over-magnetisation voltage gain (V/f), 1st-motor	50~400(%)	100
<b>bA149</b> Over-magnetization control level setting (V/f), 1st-motor	(200V Class) 330.0~390.0(Vdc) (400V Class) 660.0~780.0(Vdc)	(200V Class) 380 (400V Class) 760

- This function disables the AVR function output voltage, works while in over-excitation.
- When [AA121]=00~02, 04~06, (V/f) is enabled.
- When [bA146]=03/04, it will be operative if DC voltage exceeds [bA-149] level.

**Dynamic braking (BRD) function**

Code/Name	Range (unit)	Initial value
<b>bA-60</b> Dynamic braking usage ratio	0.0~100.0(%)	10.0
<b>bA-61</b> Dynamic braking control	00(Disable)/01(Only while running)/02(Enable during stop)	00
<b>bA-62</b> Dynamic braking activation level	(200V class) 330.0~390.0(V) (400V class) 660.0~780.0(V)	(200V class) 360.0 (400V class) 720.0
<b>bA-63</b> Dynamic braking resistor value	Inverter minimum resistor value 600(Ω)	Minimum resistance

- This function operates the braking resistor of the built-in braking circuits models. To use the BRD, setting [bA-60] and [bA-61] is required.

[bA-70]~[bA249]

**Cooling-fan operation**

Code/Name	Range (unit)	Initial value
<b>bA-70</b> Cooling fan control selection	00(Always ON)/01(While inverter operates)/02(Depends on temperature)	00
<b>bA-71</b> Cooling fan control selection	00(Disable)/01(Clear)	00

- The Inverter cooling fan can be stopped.
- If you change the cooling-fan, assigning [bA-71]=01 you will be able to clear the accumulated operation time.

**2nd motor** When Intelligent Input terminal 024[SET] is enabled.

Code/Name	Range (unit)	Initial value
<b>bA202</b> Frequency upper limit, 2nd motor	Same as bA102	
<b>bA203</b> Frequency lower limit, 2nd motor	Same as bA103	
<b>bA210</b> Torque limit selection, 2nd motor	Same as bA110	
<b>bA211</b> Torque limit LADSTOP enable, 2nd motor	Same as bA111	
<b>bA212</b> Torque limit (1) (forward-driving in 4-quadrant mode), 2nd motor	Same as bA112	
<b>bA213</b> Torque limit (2) (reverse- regenerating in 4-quadrant mode), 2nd motor	Same as bA113	
<b>bA214</b> Torque limit (3) (reverse-driving in 4-quadrant mode), 2nd motor	Same as bA114	
<b>bA215</b> Torque limit (4) (forward- regenerating in 4-quadrant mode), 2nd motor	Same as bA115	
<b>bA220</b> Overcurrent suppression enable, 2nd motor	Same as bA120	
<b>bA221</b> Overcurrent suppression level, 2nd-motor	Same as bA121	
<b>bA222</b> Overload restriction 1 selection, 2nd-motor	Same as bA122	
<b>bA223</b> Overload restriction 1 level, 2nd-motor	Same as bA123	
<b>bA224</b> Overload restriction 1 active time, 2nd-motor	Same as bA124	
<b>bA226</b> Overload restriction 2 selection, 2nd-motor	Same as bA126	
<b>bA227</b> Overload restriction 2 level, 2nd-motor	Same as bA127	
<b>bA228</b> Overload restriction 2 active time, 2nd-motor	Same as bA128	
<b>bA240</b> Overvoltage suppression enable, 2nd-motor	Same as bA140	
<b>bA241</b> Overvoltage suppression level, 2nd-motor	Same as bA141	
<b>bA242</b> Overvoltage suppression action time, 2nd-motor	Same as bA142	
<b>bA244</b> Overvoltage suppression proportional gain, 2nd-motor	Same as bA144	
<b>bA245</b> Overvoltage suppression integral time, 2nd-motor	Same as bA145	
<b>bA246</b> Over-excitation function selection, 2nd-motor	Same as bA146	
<b>bA247</b> Time constant of over-excitation output filter (V/f), 2nd-motor	Same as bA147	
<b>bA248</b> Over-excitation voltage gain, 2nd-motor	Same as bA148	
<b>bA249</b> Over-excitation control level setting, 2nd-motor	Same as bA149	

[bb101]~[bb42]

[bb45]~[bb59]

**Reduction of electromagnetic sound**

Code/Name	Range (unit)	Initial value
<b>bb101</b> Carrier frequency, 1st-motor	0.5~16.0(kHz)	2.0
<b>bb102</b> Sprinkle carrier pattern selection, 1st-motor	00(Disable)/ 01(Enable: Patern-1)/ 02(Enable: Patern-2)/ 03(Enable: Patern-3)	00
<b>bb103</b> Automatic carrier frequency reduction selection, 1st-motor	00(Disable)/ 01(Enable: Current)/ 02(Enable: Temperature)	00

- To decrease noise, [bb101] should be set small. To lower electromagnetic sound, [bb101] has to be set bigger.
- By setting the duty specification selection [Ub-03], the carrier frequency is internally limited.
- For the sake of the inverter protection, the Automatic carrier reduction [bb103] decreases the carrier in certain cases.

**Reset operation after error event**

Code/Name	Range (unit)	Initial value
<b>bb-10</b> Automatic error reset selection	00(Disable)/ 01(If RUN command is OFF) 02(After set time)/ 04(Emergency force drive)	00
<b>bb-11</b> Automatic error reset wait time	00(Enable)/ 01(Disable)	00
<b>bb-12</b> Automatic reset waiting time	0.0~600.0(s)	2.0
<b>bb-13</b> Automatic error reset number	0~10(count)	3

- Adjustment of the automatic reset that follows an error event. In the case that RUN command was on execution, after the reset, is followed by the setting of [bb-41].

**Retry/trip setting in error event**

Code/Name	Range (unit)	Initial value
<b>bb-20</b> Retry count after power loss event	0~16/255	0
<b>bb-21</b> Retry count after undervoltage event	0~16/255	0
<b>bb-22</b> Retry count after overcurrent event	0~5	0
<b>bb-23</b> Retry count after overvoltage event	0~5	0

- Sets number of retries before tripping.
- If 0 is set, as soon as an error occurs, it will trip.
- If you want to reset the retry count, assign any value other than 0.

Code/Name	Range (unit)	Initial value
<b>bb-24</b> Selection of restart mode at Instantaneous power failure/ under-voltage trip	*3)	00
<b>bb-25</b> Allowable under-voltage power failure time	0.3~25.0(s)	1.0
<b>bb-26</b> Retry wait time before motor restart	0.3~100.0(s)	1.0
<b>bb-27</b> Instantaneous power failure/under-voltage trip alarm enable	00(Disable)/ 01(Enable)/ 02(Disable at Stop/Decel. stop)	00
<b>bb-28</b> Selection of restart mode at over-current	*3)	00
<b>bb-29</b> Wait time of restart at over-current	0.3~100.0(s)	1.0
<b>bb-30</b> Selection of restart mode at over-voltage	*3)	00
<b>bb-31</b> Wait time of restart at over-voltage	0.3~100.0(s)	1.0

\*3) 00(Restart motor with 0Hz)/01(Restart with a matching frequency)/02(Restart with active frequency matching)/03(Detect speed)/04(Decelerate and stop with a matching frequency and then trip)

- Regarding the restart, after the waiting time is completed the selected restart method is carried out.

**Restart mode after FRS/RS**

Code/Name	Range (unit)	Initial value
<b>bb-40</b> Restart mode after FRS release	*4)	00
<b>bb-41</b> Restart mode after RS release		00

\*4) 00(Start with 0Hz)/01(Start with matching frequency)/02(Start with active frequency matching)/03(Detect speed)/

- When using Intelligent input terminals [FRS] and [RS], restart mode can be selected.
- [bb-40] allows you to select the restart operation after a free-run stop.
- [bb-41] allows you to select the restart operation after a trip or reset event.

**Minimum level of frequency matching**

Code/Name	Range (unit)	Initial value
<b>bb-42</b> Restart frequency threshold	0.00~590.00(Hz)	0.00

- The matching frequency function adopts the motor frequency for a shockless start-up.
- If at the restart the frequency is under the [bb-42] frequency, a 0Hz restart will be used instead.

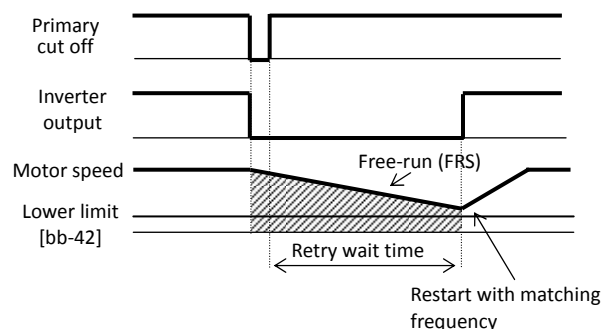

[bb-43]~[bb-62]

Active frequency matching

Code/Name	Range (unit)	Initial value
<b>bb-43</b> Restart level of Active frequency matching	Inverter rated current ×(0.20~2.00)	Inverter rated current×1.00
<b>bb-44</b> Restart constant(speed) of Active Frequency matching	0.10~30.00(s)	0.5
<b>bb-45</b> Restart constant(Voltage) of Active Frequency matching	0.10~30.00(s)	0.5
<b>bb-46</b> OC-supress level of Active frequency matching	Inverter rated current ×(0.20~2.00)	Inverter rated current×1.00
<b>bb-47</b> Restart speed selection of Active frequency matching	00(Frequency set when inverter output shut off)/ 01(Maximum frequency)/ 02(Set frequency)	00

- The reset interval is set with [bb-46].
- Starts scanning from the frequency set in [bb-47].

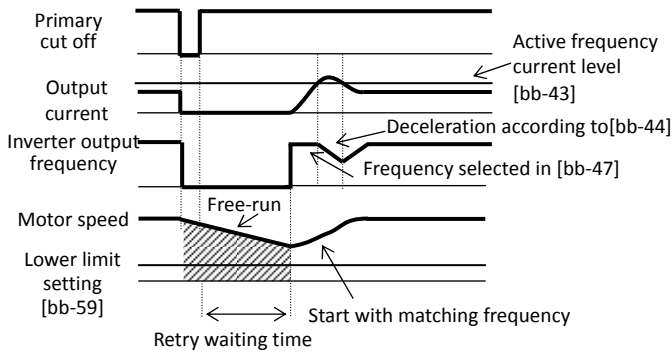

Overcurrent level

Code/Name	Range (unit)	Initial value
<b>bb160</b> Over current detection level, 1st-motor	Inverter rated current × (0.20~2.20)	Inverter rated current×2.20

- The motor protection level for overcurrent can be set.
- In the case of a permanent magnet motor is set lower than the motor demagnetizing level.

Overvoltage warning

Code/Name	Range (unit)	Initial value
<b>bb-61</b> Power supply over voltage selection	00(Warning)/ 01(Error)	00
<b>bb-62</b> Power supply over voltage level setting	(200V Class) 300.0~400.0(V) (400V Class) 600.0~800.0(V)	(200V Class) 390.0 (400V Class) 780.0

- When the input suffers an overvoltage and if the DC voltage is higher than the value in [bb-62], a warning is issued in accordance with [bb-61].

[bb-65]~[bb260]

Phase loss detection

Code/Name	Range (unit)	Initial value
<b>bb-65</b> Input phase loss enable	00(Disable)/01(Enable)	00
<b>bb-66</b> Output phase loss enable	00(Disable)/01(Enable)	00
<b>bb-67</b> Output phase loss detection sensitivity	1~100(%)	10

- Detects the disconnection of the supply RST input line and UVW output line.

Thermistor error detection

Code/Name	Range (unit)	Initial value
<b>bb-70</b> Thermistor error level	0~10000(Ω)	3000
<b>Cb-40</b> Thermistor type selection	00(Disable)/ 01(PTC)/02(NTC)	00

- In [TH] terminal must be attached the kind of thermistor specified in [CA-60].
- If [CA-60]=01 or 02, error level must be set in [bb-70].

Overspeed control

Code/Name	Range (unit)	Initial value
<b>bb-80</b> Overspeed detection level	0.0~150.0(%)	135.0
<b>bb-81</b> Overspeed detection time	0.0~5.0(s)	0.5

- In vector control, when speed arrives to “maximum speed”×[bb-75], and pass over [bb-76], results in error.

Abnormal deviation in speed control

Code/Name	Range (unit)	Initial value
<b>bb-82</b> Speed deviation error mode selection	00(Disable)/ 01(Enable)	00
<b>bb-83</b> Speed deviation error detection level	0.0~100.0(%)	15.0
<b>bb-84</b> Speed deviation error detection time	0.0~5.0(s)	0.5

- In vector control, when speed arrives to “maximum speed”×[bb-83] and pass over [bb-84], results in error.

Abnormal deviation in position control

Code/Name	Range (unit)	Initial value
<b>bb-85</b> Position deviation error mode selection	00(Disable)/ 01(Enable)	00
<b>bb-86</b> Position deviation error detection level	0~65535 (×100pulse)	4096
<b>bb-87</b> Position deviation error detection level	0.0~5.0(s)	0.5

- During position control, if the position deviation exceeds the [bb-86], if exceeds the [bb-87] time, will result in an error.

2nd motor When Intelligent Input terminal 024[SET] is enabled.

Code/Name	Range (unit)	Initial value
<b>bb201</b> Carrier frequency, 2nd-motor	Same as bb101	
<b>bb203</b> Automatic carrier frequency reduction enable, 2nd-motor	Same as bb103	
<b>bb260</b> Overcurrent detection level, 2nd-motor	Same as bb160	



[bC110]~[bC125]

Electronic thermal protection

Code/Name	Range (unit)	Initial value
<b>bC110</b> Electronic thermal level setting, 1st-motor	Motor rated current × (0.20~3.00)	Motor rated current ×1.00
<b>bC111</b> Electronic thermal characteristic selection, 1st-motor	00(Reduced torque (VT))/ 01(Constant torque (CT))/ 02(Free setting)	00(JPN)/ 01(EU)(USA) (ASIA)(CHN)
<b>bC112</b> Electronic thermal Subtraction function enable, 1st-motor	00(Disable)/ 01(Enable)	01
<b>bC113</b> Electronic thermal Subtraction time, 1st-motor	1~1000(s)	600
<b>bC-14</b> Electronic thermal counter memory selection at Power-off	00(Disable)/ 01(Enable)	01
<b>bC120</b> Free electronic thermal frequency-3, 1st-motor	0.00 ~bC122(Hz)	0.00
<b>bC121</b> Free electronic thermal current-1, 1st-motor	Inverter rated current × (0.00~1.00)	0.00
<b>bC122</b> Free electronic thermal frequency-2, 1st-motor	bC120 ~bC124(Hz)	0.00
<b>bC123</b> Free electronic thermal current-2, 1st-motor	Inverter rated current × x(0.00~1.00)	0.00
<b>bC124</b> Free electronic thermal frequency-3, 1st-motor	bC122 ~590.00(Hz)	0.00
<b>bC125</b> Free electronic thermal current-3, 1st-motor	Inverter rated current × x(0.00~1.00)	0.00

- With [bC112], it is possible to subtract the thermal integral value of the motor.

(Example) When [bC111]=00, Inverter rated current:64A, [bC110]=64(A), Base frequency [Hb104]=60Hz, Output frequency=20Hz

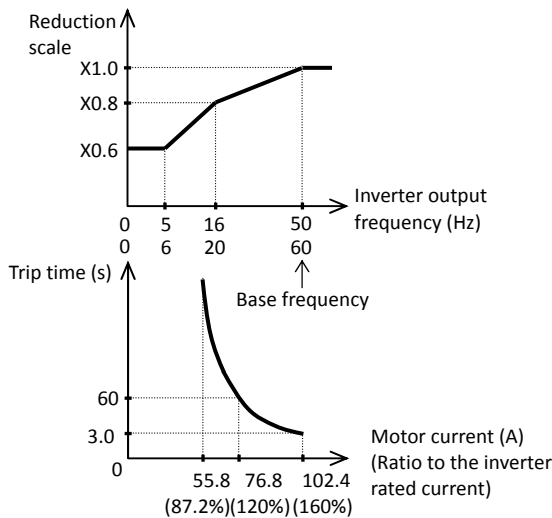

- In case of output frequency = 16Hz (base=50Hz) or 20Hz (base = 60hz), the reduction scale is ×0.8, then the inverter will trip when the output current of 120%(150%×0.8) flows continuously within 60s according to the curve.

[bC210]~[bC225]

(Example) When [bC111]=01, Inverter rated current:64A, [bC110]=64(A), Base frequency[Hb103]=60Hz, Output frequency=2.5Hz

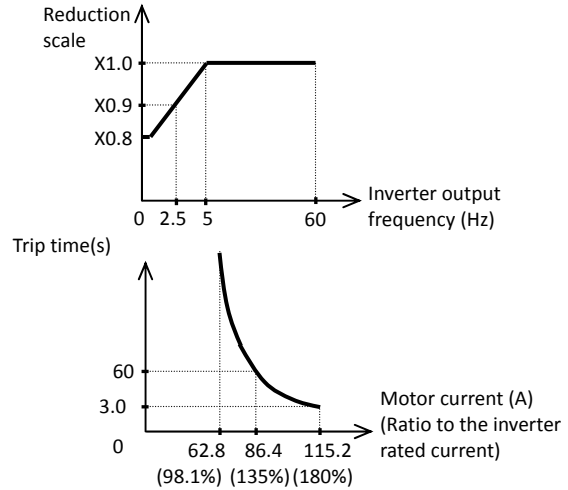

- In case of output frequency = 2.5Hz, the reduction scale is x0.9, then, the inverter will trip when the output current of 135%(=150%×0.9) flows continuously within 60s according to the curve.

(Example) When [bC111]=02, and there is Output frequency [bC122]

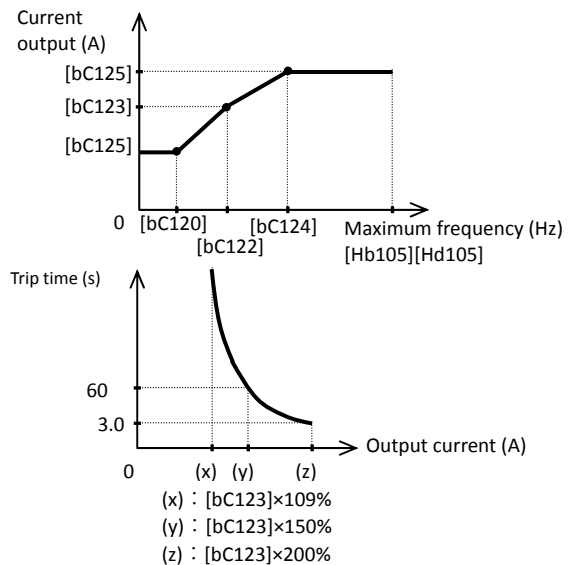

2nd motor When Intelligent Input terminal 024[SET] is enabled.

Code/Name	Range (unit)	Initial value
<b>bC210</b> Electronic thermal level, 2nd-motor	Same as bC110	
<b>bC211</b> Electronic thermal characteristic selection, 2nd-motor	Same as bC111	
<b>bC212</b> Electronic thermal subtraction function selection, 2nd-motor	Same as bC112	
<b>bC213</b> Electronic thermal subtraction time, 2nd-motor	Same as bC113	
<b>bC220</b> Free setting, electronic thermal frequency (1), 2nd-motor	Same as bC120	
<b>bC221</b> Free setting, electronic thermal current (1), 2nd-motor	Same as bC121	
<b>bC222</b> Free setting, electronic thermal frequency (2), 2nd-motor	Same as bC122	
<b>bC223</b> Free setting, electronic thermal current (2), 2nd-motor	Same as bC123	
<b>bC224</b> Free setting, electronic thermal frequency (3), 2nd-motor	Same as bC124	
<b>bC225</b> Free setting, electronic thermal current (3), 2nd-motor	Same as bC125	

[bd-01]~[bd-04][bE-02]~[bE-18]

**Safety terminal**

Code/Name	Range (unit)	Initial value
<b>bd-01</b> STO input display selection	00(Display)/ 01(No display)/ 02(Trip)	00
<b>bd-02</b> STO input change time	0.00~60.00(s)	1.00
<b>bd-03</b> Display selection at STO input change time	00(Display)/ 01(No display)	00
<b>bd-04</b> Action selection after STO input change time	00(Trip)/ 01(Maintain current status)/ 02(Disable)	00

- For more information, refer to the user's guide.

[CA-01]~[CA-31]

Parameter mode (C code)

Input terminal settings

Code/Name	Range (unit)	Initial value	
CA-01 Input terminal [1] function	Reference <Input terminal function list>	028	
CA-02 Input terminal [2] function		015	
CA-03 Input terminal [3] function		029	
CA-04 Input terminal [4] function		032	
CA-05 Input terminal [5] function		031	
CA-06 Input terminal [6] function		103 [PLA] Pulse train input A is restricted to [CA-10],	003
CA-07 Input terminal [7] function			004
CA-08 Input terminal [8] function		104 [PLB] Pulse train input B is restricted to [CA-11],	002
CA-09 Input terminal [9] function			001
CA-10 Input terminal [A] function			033
CA-11 Input terminal [B] function			034

- The functions for the input terminals 1~9,A,B are assigned in [CA-01]~[CA-09],[CA-10],[CA-11].

Input terminal NO/NC settings

Code/Name	Range (unit)	Initial value
CA-21 Input terminal [1] active state	00(Normally Open: NO)/ 01(Normally Closed: NC)	00
CA-22 Input terminal [2] active state		00
CA-23 Input terminal [3] active state		00
CA-24 Input terminal [4] active state		00
CA-25 Input terminal [5] active state		00
CA-26 Input terminal [6] active state		00
CA-27 Input terminal [7] active state		00
CA-28 Input terminal [8] active state		00
CA-29 Input terminal [9] active state		00
CA-30 Input terminal [A] active state		00
CA-31 Input terminal [B] active state		00

- The functions for the Intelligent input terminals 1~9,A,B are assigned in [CA-21]~[CA-29],[CA-30],[CA-31].
- However, in the case of [RS] assignment the NO/NC will not apply, only NO will apply.

[CA-41]~[CA-55]

Output terminal chatter prevention

Code/Name	Range (unit)	Initial value
CA-41 Input terminal [1] response time	0~400(ms)	2
CA-42 Input terminal [2] response time		2
CA-43 Input terminal [3] response time		2
CA-44 Input terminal [4] response time		2
CA-45 Input terminal [5] response time		2
CA-46 Input terminal [6] response time		2
CA-47 Input terminal [7] response time		2
CA-48 Input terminal [8] response time		2
CA-49 Input terminal [9] response time		2
CA-50 Input terminal [A] response time		2
CA-51 Input terminal [B] response time		2

- Sets the time to wait after the input change has ended, and for the input to become stable and responsive.

Time allowed in simultaneous terminal change

Code/Name	Range (unit)	Initial value
CA-55 Multistage input determination time	0~2000(ms)	0

- Sets the dead time for multistage speed and position terminals change.

[Input terminal function list]

Function code	Symbol	Function name	Description
000	no	Not use	-
001	FW	Forward rotation	Activating (ON) only one of them will grant forward or reverse rotation command. ⇒ [AA111]
002	RV	Reverse rotation	
003	CF1	Multi speed selection 1	Changing the states of these terminals, allows to set different motor speeds and change among them. ⇒ [Ab110]~[Ab-25], [Ab210]
004	CF2	Multi speed selection 2	
005	CF3	Multi speed selection 3	
006	CF4	Multi speed selection 4	
007	SF1	Multi speed Bit-7	
008	SF2	Multi speed Bit-2	
009	SF3	Multi speed Bit-3	
010	SF4	Multi speed Bit-4	
011	SF5	Multi speed Bit-5	
012	SF6	Multi speed Bit-6	
013	SF7	Multi speed Bit-6	
014	ADD	Trigger for frequency addition[Ab105]	When is turned ON, adds the specified frequency value. ⇒ [AA106]
015	SCH G	Speed reference change	Main speed(OFF)/Sub-speed (ON), to change between them use ⇒ [AA105].
016	STA	3-wire Start	If [STA] is ON, start the motor. If [STP] is ON stop the motor. Forward operation direction if [FR] is (OFF), reverse operation direction if is (ON). ⇒ [AA111]
017	STP	3-wire Stop	
018	FR	Forward Over Travel	
019	AHD	analog command holding	When the Analog inputs Ai1,2,3 are in use, if AHD terminal is in ON state, holds the Analog terminal value. ⇒ [AA101]
020	FUP	Remote control Speed-UP function	If the frequency can be set ([AHD] ON included), [FUP] ON accelerates, and [FDN] ON decelerates. [UDC] returns to the saved value. ⇒ [CA-62]~[CA-66]
021	FDN	Remote control Speed-DOWN function	
022	UDC	Remote control data clearing	
023	F-OP	Force operation	If ON, switch set parameters. ⇒ [CA-68],[CA-69]
024	SET	2nd-motor control	Change between 1st-motor (OFF) and 2nd-motor (ON). ⇒ By parameter
028	RS	Reset	Reset trip⇒[CA-61],[bb-41]
029	JG	Jogging	Activates Jogging operation. ⇒ [AG-20],[AG-21]
030	DB	External Dynamic brake	Enables the DC braking operation⇒ [AF101]~[AF109]
031	2CH	2-step Acceleration/Deceleration	If ON, changes the Acc/Decel time. ⇒ [AC115]
032	FRS	Free run stop	If ON allows the motor to free run. ⇒ [AA115],[bb-40]
033	EXT	External fault	If ON error E012 occurs. ⇒ Trip E012
034	USP	unattended start protection	ON if at the start-up, the RUN command was issued right at the start up, E013 error. ⇒ Tripping E013
035	CS	Commercial Supply change	When changing to the public electric grid, if it is ON, will cut the output.
036	SFT	Soft-Lock	If ON, disables parameter changes. ⇒ [UA-21]
037	BOK	Answer back from Brake	Here is inputted the brake confirmation signal for the brake control.

[Input terminal function list]

Function code	Symbol	Function name	Description
038	OLR	Overload restriction selection	Switches between Overload limit 1(OFF) and 2(ON). ⇒ [bA122]~[bA128]
039	KHC	Accumulation input power clearance	If ON, clears the Accumulated input power monitor. ⇒ [UA-14]
040	OKHC	Accumulation output power clearance	If ON, clears the Accumulated output power monitor. ⇒ [UA-12]
041	PID	Disable PID1	If ON, disables PID1 and changes the PID target value for the frequency reference. ⇒ [AH-01]
042	PIDC	PID1 integration reset	If ON, clears the integral value of the control. ⇒ [AH-62],[AH-65]
043	PID2	Disable PID2	If ON, disables PID2 and changes the PID target value for the frequency reference. ⇒ [AJ-01]
044	PIDC2	PID2 integration reset	If ON, clears the integral value of the control. ⇒ [AJ-14]
046	PID3	Disable PID3	If ON, disables PID3 and changes the PID target value for the frequency reference. ⇒ [AJ-21]
046	PIDC3	PID3 integration reset	If ON, clears the integral value of the control. ⇒ [AJ-34]
047	PID4	Disable PID4	If ON, disables PID4 and changes the PID target value for the frequency reference. ⇒ [AJ-41]
048	PIDC4	PID4 integration reset	If ON, clears the integral value of the control. ⇒ [AJ-54]
051	SVC1	Multi set-point selection 1	The target value can be selected by changing the pattern of ON/OFF states. ⇒ [AH-06]
052	SVC2	Multi set-point selection 2	
053	SVC3	Multi set-point selection 3	
054	SVC4	Multi set-point selection 4	
055	PRO	PID gain change	Switches between Gain 1(OFF) and Gain 2(ON).
056	PIO	PID output switching 1	Switches PID Output 1 to 4 by (PIO1:PIO2). PID1 Enable(OFF:OFF) PID2 Enable(OFF:ON) PID3 Enable(ON:OFF) PID4 Enable(ON:ON)
057	PIO2	PID output switching 2	
058	SLEP	SLEEP condition activation	In case it is used in Sleep terminal functions, when ON, it activates. ⇒ [AH-85]
059	WAKE	WAKE condition activation	In case it is used in Wake terminal functions, when ON, it activates. ⇒ [AH-93]
060	TL	Torque limit enable	If ON, enables torque limit.
061	TRQ1	Torque limit selection bit 1	The target value can be selected by changing the pattern of ON/OFF states.
062	TRQ2	Torque limit selection bit 2	

**[Input terminal function list]**

Function code	Symbol	Function name	Description
063	PPI	P/PI control mode selection	For drooping control, switches between PI control (OFF) and P control (ON).
064	CAS	Control gain change	Changes between the PI gain 1 (OFF) and 2(ON) of the speed control system.
065	SON	Servo-on	If ON, executes the Servo-Lock operation.
066	FOC	Forcing	If ON, performs a forcible operation, will accelerate the rise of the torque.
067	ATR	Permission of torque control	If ON, enables the torque limit.
068	TBS	Torque Bias enable	If ON, enables the torque bias.
069	ALP	Home search function	If ON, when in position control mode, stops by home search.
071	LAC	Acceleration/Deceleration cancellation	If ON, forces Acc/Decel time to 0.00s.
072	PCLR	Clearance of position deviation	Clears the position deviation of position control mode.
073	STAT	pulse train position command input enable	In the pulse train position control, if is ON, the input is enabled.
074	PUP	Position bias (ADD)	If in position control mode, if [PUP] is ON, adds, if [PDN] is ON, subtracts.
075	PDN	Position bias (SUB)	
076	CP1	Multistage position settings selection 1	The position reference can be selected by changing the pattern of ON/OFF states.
077	CP2	Multistage position settings selection 2	
078	CP3	Multistage position settings selection 3	
079	CP4	Multistage position settings selection 4	
080	ORL	Limit signal of Homing function	Used by the Zero-Return position operations of the position control.
081	ORG	Start signal of Homing function	
082	FOT	Forward Over Travel	Limits forward motion by forward limit torque.
083	ROT	Reserve Over Travel	Limits reverse motion by reverse limit torque.
084	SPD	speed / position switching	Switches position control(OFF) and speed control(ON).
085	PSET	Position data presetting	If ON, sets the actual position as the origin point.
086	MI1	General-purpose input 8	To be set if you want to make use of an input signal for EzSQ function.
087	MI2	General-purpose input 11	
088	MI3	General-purpose input 11	
089	MI4	General-purpose input 11	
090	MI5	General-purpose input 11	
091	MI6	General-purpose input 11	
092	MI7	General-purpose input 11	
093	MI8	General-purpose input 11	
094	MI9	General-purpose input 9	
095	MI10	General-purpose input 10	
096	MI11	General-purpose input 11	
097	PCC	Pulse counter clearing	Clear the count for the pulse counter function.

**[Input terminal function list]**

Function code	Symbol	Function name	Description
098	ECOM	EzCOM activation	If ON, activates EzCOM.
099	PRG	Program RUN	If ON, EzSQ is executed.
100	HLD	Acceleration/Deceleration disable	If ON, temporally stagnates Acc/Decel.
101	REN	RUN enable	If ON, operation is enable. If it is not assigned, it disables operation.
102	DISP	Display lock	If made ON, the keypad screen is lock and the RUN key is disabled.
103	PLA	Pulse count A	For pulse train input use.
104	PLB	Pulse count B	For pulse train input use.
105	EMF	Emergency-Force Drive activation	Forces the set operation in emergency state.
107	COK	Contact check signal	Regarding the braking control, check signal for the contactor.
108	DTR	Data trace start	If ON, starts data trace function.
109	PLZ	Pulse train input Z	
110	TCT	Teach-in signal	If ON, starts function.

[CA-60]~[CA-84]

[CA-90]~[CA-99]

[FUP]/[FDN] operations

Code/Name	Range (unit)	Initial value
<b>CA-60</b> FUP/FDN overwrite target selection	00(Speed reference) 01(PID)	00
<b>CA-61</b> FUP/FDN data save enable	00(No save)/ 01(Save)	00
<b>CA-62</b> UDC terminal mode selection	00(0Hz)/ 01(Save data)	00
<b>CA-64</b> Acceleration time for FUP/FDN function	0.00~3600.00(s)	30.00
<b>CA-66</b> Deceleration time for FUP/FDN function		30.00

- [CA-60] sets as operation target the frequency reference or the PID target value for 020[FUP]/021[FDN].
- [CA-61] sets if the modified values of [FUP] / [FDN] should be saved or not in the storage memory.
- [CA-62] selects the frequency in which will change the frequency reference for when [UDC] terminal is ON.
- If [FUP]/[FDN] is turn ON, in the case the frequency reference is changed you can set the acceleration and deceleration time [CA-64][CA-66].

[F-OP] Speed/Operation change

Code/Name	Range (unit)	Initial value
<b>CA-70</b> Speed command selection when [F-OP] active	01~03, 07, 08, 12, 14, 15 *1)	01
<b>CA-71</b> Operation command reference selection when [F-OP] active	00~03 *2)	01

- If Intelligent input terminal 023[F-OP] is ON the change is carried out.

\*1)01(Ai1 terminal)/02(Ai2 terminal)/03(Ai3 terminal)/ 07(Parameter)/ 08(RS485)/ 12(Pulse train input:main)/14(EzSQ function)/15(PID result)

\*2) 00([FW]/[RV] terminal)/01(3-wire)/02(Keypad's RUN key)/03(RS485)

Reset terminal [RS]

Code/Name	Range (unit)	Initial value
<b>CA-72</b> Reset mode selection	00(Trip release at turn-ON)/ 01(Trip release at turn-OFF)/ 02(Effective only in trip ON condition)/ 03(Effective only in trip OFF condition)	00

- Output is shut off when reset terminal is ON. This terminal is valid only while in trip status.

Main encoder input

Code/Name	Range (unit)	Initial value
<b>CA-81</b> Encoder constant setting	0~65535(Pls)	1024
<b>CA-82</b> Encoder phase selection	00(Phase A precedent)/ 01(Phase B precedent)	00
<b>CA-83</b> Numerator of the motor gear ratio	1~10000	1
<b>CA-84</b> Denominator of the motor gear ratio	1~10000	1

- Sets the main encoder input and the motor gear ratio involved in the encoder feedback.

Pulse train input terminal

Code/Name	Range (unit)	Initial value	
Pulse train input (main)	<b>CA-90</b> Pulse train detection object selection	00(Frequency reference)/ 01(Pulse count)/ 02(Speed feedback : sensor-V/f)	00
	<b>CA-91</b> Mode selection of pulse train input	00(90°-phase-shift)/ 01(Forward/reverse operation and direction of rotation)/ 02(Forward/reverse operation with pulse train)	00
Pulse train frequency (main)	<b>CA-92</b> pulse train frequency Scale	0.05~32.0(kHz)	25.0
	<b>CA-93</b> pulse train frequency filter time constant	0.01~2.00(s)	0.10
	<b>CA-94</b> pulse train frequency Bias value	-100.0~100.0(%)	0.0
	<b>CA-95</b> Pulse train frequency high limit	0.0~100.0(%)	100.0
	<b>CA-96</b> Pulse train frequency detection Low level	0.0~100.0(%)	0.0

- A pulse train is introduced in functions [PLA][PLB] assigned to terminals A,B. If [CA-90]=01, pulses in terminals A & B are counted. Only terminal A in case that is a single phase input.

Pulse train counter

Code/Name	Range (unit)	Initial value
<b>CA-97</b> Comparing match output ON-level for pulse count	0~65535	0
<b>CA-98</b> Comparing match output OFF-level for pulse count	0~65535	0
<b>CA-99</b> Comparing match output Maximum value for pulse count	0~65535	65535

- Set 091[PCMP] to output the compare results of the pulse train counters of functions 103[PLA]/104[PLB].
- Turning 097[PCC] terminal in ON state resets the counter.
- In the following example, when [CA-81]=01, inputting a pulse train in terminal A.

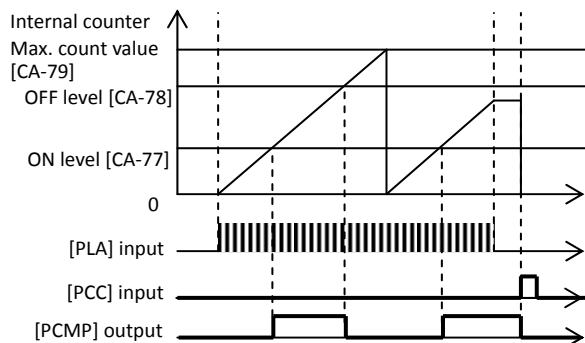

[Cb-01]~ [Cb-35]

[CA-40][Cb-41][CC-01]~[CC-17]

**Analog input acquisition**

	Code/Name	Range (unit)	Initial value
[Ai1] terminal	<b>Cb-01</b> Time constant of filter	1~500(ms)	16
	<b>Cb-03</b> Start value	0.00~100.00(%)	0.00
	<b>Cb-04</b> End value	0.00~100.00(%)	100.00
	<b>Cb-05</b> Start ratio	0.0~[Cb-06](%)	0.0
	<b>Cb-06</b> End ratio	[Cb-05]~100.0(%)	100.0
	<b>Cb-07</b> Start selection	00(Initial value)/ 01(0%)	01
	[Ai2] terminal	<b>Cb-11</b> Time constant of filter	1~500(ms)
<b>Cb-13</b> Start value		0.00~100.00(%)	0.00
<b>Cb-14</b> End value		0.00~100.00(%)	100.00
<b>Cb-15</b> Start ratio		0.0~[Cb-16](%)	0.0
<b>Cb-16</b> End ratio		[Cb-15]~100.0(%)	100.0
<b>Cb-17</b> Start selection		00(Initial value)/ 01(0%)	01
[Ai3] terminal	<b>Cb-21</b> Time constant of filter	1~500(ms)	16
	<b>Cb-22</b> Operation selection	00(Individual)/ 01(Ai1/Ai2 add: with inversion)/ 02(Ai1/Ai2 add: without inversion)	00
	<b>Cb-23</b> Start value	-100.00~100.00(%)	-100.00
	<b>Cb-24</b> End value	-100.00~100.00(%)	100.00
	<b>Cb-25</b> Start ratio	-100.0~[Cb-26]	-100.0
	<b>Cb-26</b> End ratio	[Cb-25]~100.0	100.0

- Regarding the adjustment method of the Analog input, please refer to the chapter 3 example of I/O terminals adjustment.

**Analog input fine tuning**

Code/Name	Range (unit)	Initial value
<b>Cb-30</b> [Ai1] Voltage/Current zero-bias adjustment	-200.00 ~ 200.00(%)	0.00
<b>Cb-31</b> [Ai1] Voltage/Current gain adjustment	-200.00 ~ 200.00(%)	100.00
<b>Cb-32</b> [Ai2] Voltage/Current zero-bias adjustment	-200.00 ~ 200.00(%)	0.00
<b>Cb-33</b> [Ai2] Voltage/Current gain adjustment	-200.00 ~ 200.00(%)	100.00
<b>Cb-34</b> [Ai3] Voltage -10 bias adjustment	-200.00 ~ 200.00(%)	0.00
<b>Cb-35</b> [Ai3] Voltage gain adjustment	-200.00 ~ 200.00(%)	100.00

- Regarding the adjustment method of the Analog input, please refer to the chapter 3 example of I/O terminals adjustment.
- The thermistor adjustment, when recognizes an increase in the adjustment value, reduces the resistor value.

**Thermistor error detection**

Code/Name	Range (unit)	Initial value
<b>CA-40</b> Thermistor type selection	00(Disable)/ 01(PTC)/02(NTC)	00
<b>Cb-41</b> Thermistor gain adjustment	0.0~1000.0	100.0

- Set [CA-40] according to the connected thermistor in TH input terminal.
- When [CA-40]=01 or 02, with [bb-70] the error level is set. Refer to [bb-70].
- [Cb-41] thermistor gain adjustment, when the adjustment value is raised the resistance value is lowered.

**Output terminal settings**

Code/Name	Range (unit)	Initial value
<b>CC-01</b> Output terminal [11] function	Reference <Intelligent output terminal function list>	002
<b>CC-02</b> Output terminal [12] function		001
<b>CC-03</b> Output terminal [13] function		035
<b>CC-04</b> Output terminal [14] function		019
<b>CC-05</b> Output terminal [15] function		030
<b>CC-06</b> Output terminal [16] function		018
<b>CC-07</b> Output terminal [AL] function		017

- The functions for the output terminals 11~15,16A,AL are assigned in [CC-01]~[CC-05],[CC-06],[CC-07].

**Output terminal NO/NC settings**

Code/Name	Range (unit)	Initial value
<b>CC-11</b> Output terminal [11] active state	00(Normally open: NO)/ 01(Normally closed: NC)	00
<b>CC-12</b> Output terminal [12] active state		00
<b>CC-13</b> Output terminal [13] active state		00
<b>CC-14</b> Output terminal [14] active state		00
<b>CC-15</b> Output terminal [15] active state		00
<b>CC-16</b> Output terminal [16] active state		00
<b>CC-17</b> Output terminal [AL] active state		01

- The functions for the Intelligent output terminals 11~15,16,AL are assigned in [CC-11]~[CC-15], [CC-16], [CC-17].

## [CC-20]~[CC-33]

## Output terminal response

Code/Name	Range (unit)	Initial value
<b>CC-20</b> Output terminal [11] on-delay time	0.00~100.00(s)	0.00
<b>CC-21</b> Output terminal [11] off-delay time	0.00~100.00(s)	0.00
<b>CC-22</b> Output terminal [12] on-delay time	0.00~100.00(s)	0.00
<b>CC-23</b> Output terminal [12] off-delay time	0.00~100.00(s)	0.00
<b>CC-24</b> Output terminal [13] on-delay time	0.00~100.00(s)	0.00
<b>CC-25</b> Output terminal [13] off-delay time	0.00~100.00(s)	0.00
<b>CC-26</b> Output terminal [14] on-delay time	0.00~100.00(s)	0.00
<b>CC-27</b> Output terminal [14] off-delay time	0.00~100.00(s)	0.00
<b>CC-28</b> Output terminal [15] on-delay time	0.00~100.00(s)	0.00
<b>CC-29</b> Output terminal [15] off-delay time	0.00~100.00(s)	0.00
<b>CC-30</b> Output terminal [16] on-delay time	0.00~100.00(s)	0.00
<b>CC-31</b> Output terminal [16] off-delay time	0.00~100.00(s)	0.00
<b>CC-32</b> Output terminal [AL] on-delay time	0.00~100.00(s)	0.00
<b>CC-33</b> Output terminal [AL] off-delay time	0.00~100.00(s)	0.00

- Sets the delay time since the output terminal changes, until it actually become responsive.

## [Intelligent output terminal function list]

Function code	Symbol	Function name	Description
000	no	Not use	
001	RUN	Running	While output is active
002	FA1	Constant-speed reached	When constant speed reached, ON
003	FA2	Set speed overreached	ON at reaching the specified frequency or more
004	FA3	Set frequency reached	ON only at reaching the specified frequency
005	FA4	Set speed overreached 2	ON at reaching the specified frequency 2 or more
006	FA5	Set speed reached	ON only at reaching the specified frequency 2
007	IRDY	inverter ready	ON when inverter is ready
008	FWR	Forward rotation	ON while in forward drive
009	RVR	Reverse rotation	ON while in reverse drive
010	FREF	Speed referenc = Keypad is selected	ON if the frequency reference is from keypad
011	REF	Run command = Keypad is selected	ON if the motion operation is from operation keypad
012	SETM	2nd control is selcted	ON if 2nd-motor selected
016	OPO	Option output	Controlled by the Option
017	AL	Alarm	ON when trip happens
018	MJA	Major failure	ON if major failure trips
019	OTQ	Over-torque	ON if torque is exceeded
020	IP	Instantaneous power failure	ON if control power drops
021	UV	Undervoltage	ON if main voltage drops
022	TRQ	Torque limited	ON if torque limit operates
023	IPS	IP-Non stop function is active	ON if set in power loss
024	RNT	Accumulated operation time over	ON if set time is exceeded
025	ONT	Accumulated power-on time over	ON if set time is exceeded
026	THM	Electronic thermal alarm signal(MTR)	ON if motor thermal integral value exceeds set value
027	THC	Electronic thermal alarm signal(CTL)	ON if inverter thermal integral value exceeds set value
029	WAC	Capacitor life warning	ON by life warning
030	WAF	Cooling-fan speed drop	ON by life warning
031	FR	Starting contact signal	On while in operation
032	OHF	Heat sink overheat warning	ON when the heatsink is overheated.
033	LOC	Low-current indication signal	ON if output current is less than the specified value
034	LOC2	Low-current indication signal 2	ON if output current is less than the specified value
035	OL	Overload notice advance signal (1)	ON if output current exceeds specified value
036	OL2	Overload notice advance signal (2)	ON if output current exceeds specified value
037	BRK	Brake release	ON when brake releases
038	BER	Brake error	ON if abnormality in sequence happens
039	CON	Contact control	ON if contactor releases



[Output terminal function list]

Function code	Symbol	Function name	Description
040	ZS	Zero speed detection	ON if output frequency is less than set value
041	DSE	Speed deviation over	ON if speed deviation exceeds the set value
042	PDD	Position deviation over	ON if position deviation exceeds the set value
043	POK	Positioning completed	ON if positioning is completed
044	PCMP	Pulse count compare match output	ON when set value and pulse train comparator matches.
045	OD	Deviation over for PID control	ON if PID control deviation exceeds the set value
046	FBV	PID1 feedback comparison	ON if PID feedback is within range
047	OD2	OD:Deviation over for PID2 control	ON if PID control deviation exceeds the set value
048	FBV2	PID2 feedback comparison	ON if PID feedback is within range
049	NDC	Communication line disconnection	ON if communication is lost with operation keypad
050	Ai1Dc	Analog [Ai1] disconnection detection	ON if Analog input 1 is less than the set value
051	Ai2Dc	Analog [Ai2] disconnection detection	ON if Analog input 2 is less than the set value
052	Ai3Dc	Analog [Ai3] disconnection detection	ON if Analog input 3 is less than the set value
053	Ai4Dc	Analog [Ai4] disconnection detection	ON if Analog input 4 is less than the set value
054	Ai5Dc	Analog [Ai5] disconnection detection	ON if Analog input 5 is less than the set value
055	Ai6Dc	Analog [Ai6] disconnection detection	ON if Analog input 6 is less than the set value
056	WCAi1	Window comparator Ai2	ON if Analog input 1 is within range
057	WCAi2	Window comparator Ai2	ON if Analog input 2 is within range
058	WCAi3	Window comparator Ai3	ON if Analog input 3 is within range
059	WCAi4	Window comparator Ai4	ON if Analog input 4 is within range
060	WCAi5	Window comparator Ai5	ON if Analog input 5 is within range
061	WCAi6	Window comparator Ai6	ON if Analog input 6 is within range
062	LOG1	Logical operation result 1	Determined by the calculation results of two output terminals
063	LOG2	Logical operation result 2	
064	LOG3	Logical operation result 3	
065	LOG4	Logical operation result 4	
066	LOG5	Logical operation result 5	
067	LOG6	Logical operation result 6	
068	LOG7	Logical operation result 7	

[Output terminal function list]

Function code	Symbol	Function name	Description
069	MO1	General-purpose output 1	Set if case of use of EzSQ
070	MO2	General-purpose output 2	
071	MO3	General-purpose output 3	
072	MO4	General-purpose output 4	
073	MO5	General-purpose output 5	
074	MO6	General-purpose output 6	
075	MO7	General-purpose output 7	
076	EMFC	Bypass mode indicator	ON while in force operation
077	EMBP	Speed deviation over	ON while in bypass operation
078	WFT	Trace function waiting for trigger	ON while in waiting status
079	TRA	Trace function data logging	ON while in stand-by
080	LBK	Low-battery of keypad	ON while in low battery or when no contain battery on keypad
081	OV5	Over-Voltage power Supply	ON when become overvoltage in stop status
084	AC0	Alarm code bit-0	ON if detects low battery Alarm information is delivered as bit. Use the user's guide for more information.
085	AC1	Alarm code bit-1	
086	AC2	Alarm code bit-2	
087	AC3	Alarm code bit-3	
089	OD3	Deviation over for PID control	ON when PID deviation exceeds the value [AJ-37]
090	FBV3	PID3 feedback comparison	ON when PID feedback is between [AJ-38]/[AJ-39]
091	OD4	Deviation over for PID4 control	ON when PID deviation exceeds the value [AJ-57]
092	FBV4	PID4 feedback comparison	ON when PID feedback is between [AJ-58]/[AJ-59]
093	SSE	PID soft start error	ON when PID soft start became in warning status

## [CC-40]~[CC-60]

## [Cd-01]~[Cd-35]

## Combinational output terminal

Code/Name	Range (unit)	Initial value
<b>CC-40</b> Logical calculation target 1 selection of LOG1	<Intelligent output terminal function list> reference	00
<b>CC-41</b> Logical calculation target 2 selection of LOG1	<Intelligent output terminal function list> reference	00
<b>CC-42</b> Logical calculation Symbol selection of LOG1	00(AND)/01(OR)/02(XOR)	00
<b>CC-43</b> Logical calculation target 1 selection of LOG2	<Intelligent output terminal function list> reference	00
<b>CC-44</b> Logical calculation target 2 selection of LOG2	<Intelligent output terminal function list> reference	00
<b>CC-45</b> Logical calculation Symbol selection of LOG2	00(AND)/01(OR)/02(XOR)	00
<b>CC-46</b> Logical calculation target 1 selection of LOG3	<Intelligent output terminal function list> reference	00
<b>CC-47</b> Logical calculation target 2 selection of LOG3	<Intelligent output terminal function list> reference	00
<b>CC-48</b> Logical calculation Symbol selection of LOG3	00(AND)/01(OR)/02(XOR)	00
<b>CC-49</b> Logical calculation target 1 selection of LOG4	<Intelligent output terminal function list> reference	00
<b>CC-50</b> Logical calculation target 2 selection of LOG4	<Intelligent output terminal function list> reference	00
<b>CC-51</b> Logical calculation Symbol selection of LOG4	00(AND)/01(OR)/02(XOR)	00
<b>CC-52</b> Logical calculation target 1 selection of LOG5	<Intelligent output terminal function list> reference	00
<b>CC-53</b> Logical calculation target 2 selection of LOG5	<Intelligent output terminal function list> reference	00
<b>CC-54</b> Logical calculation Symbol selection of LOG5	00(AND)/01(OR)/02(XOR)	00
<b>CC-55</b> Logical calculation target 1 selection of LOG6	<Intelligent output terminal function list> reference	00
<b>CC-56</b> Logical calculation target 2 selection of LOG6	<Intelligent output terminal function list> reference	00
<b>CC-57</b> Logical calculation Symbol selection of LOG6	00(AND)/01(OR)/02(XOR)	00
<b>CC-58</b> Logical calculation target 1 selection of LOG7	<Intelligent output terminal function list> reference	00
<b>CC-59</b> Logical calculation target 2 selection of LOG7	<Intelligent output terminal function list> reference	00
<b>CC-60</b> Logical calculation Symbol selection of LOG7	00(AND)/01(OR)/02(XOR)	00

Logical output signal

## Analog output terminal adjustment

Code/Name	Range (unit)	Initial value
<b>Cd-01</b> [FM] monitor output wave form selection	00(PWM)/01(Frequency)	00
<b>Cd-02</b> [FM] monitor base frequency (at PWM output)	0~3600(Hz)	2880
<b>Cd-03</b> [FM] Monitor output selection	Set monitor code	dA-01
<b>Cd-04</b> [Ao1] Monitor output selection		dA-01
<b>Cd-05</b> [Ao2] Monitor output selection		dA-01
<b>Cd-10</b> Analog monitor adjust mode enable	00(Disable)/01(Enable)	00
<b>Cd-11</b> Filter time constant of [FM] monitor	1~500(ms)	10
<b>Cd-12</b> [FM] monitor output data type selection	00(Absolute value)/01(Signed value)	00
<b>Cd-13</b> [FM] monitor bias adjustment	-100.0~100.0(%)	0.0
<b>Cd-14</b> [FM] gain adjustment	-1000.0~1000.0(%)	100.0
<b>Cd-15</b> Output level setting at [FM] adjustment mode	0.0~300.0(%)	100.0
<b>Cd-21</b> Filter time constant of [Ao1] monitor	1~500(ms)	10
<b>Cd-22</b> [Ao1] data type selection	00(Absolute value)/01(Signed value)	00
<b>Cd-23</b> [Ao1] bias adjustment	-100.0~100.0(%)	100.0
<b>Cd-24</b> [Ao1] gain adjustment	-1000.0~1000.0(%)	100.0
<b>Cd-25</b> Output level setting at [Ao1] adjustment mode	0.0~300.0(%)	100.0
<b>Cd-31</b> Filter time constant of [Ao2] monitor	1~500(ms)	10
<b>Cd-32</b> [Ao2] data type selection	00(Absolute value)/01(Signed value)	00
<b>Cd-33</b> [Ao2] bias adjustment	-100.0~100.0(%)	0.0
<b>Cd-34</b> [Ao2] gain adjustment	-1000.0~1000.0(%)	100.0
<b>Cd-35</b> Output level setting at [Ao2] adjustment mode	-100.0~100.0(%)	100.0

- Regarding the adjustment method of the Analogue output, please refer to the chapter 3 example of I/O terminals adjustment.

- The logical operation function is used to output the combinational result of two selected output terminals.

[CE101]~[CE107]

Low-current detection signal

Code/Name	Range (unit)	Initial value
<b>CE101</b> Low-current indication signal mode selection, 1st-motor	00(During Acc/Decel and constant-speed operation) 01(only during constant-speed operation)	01
<b>CE102</b> Low-current detection level 1, 1st-motor	Inverter rated current×(0.00~2.00)	Inverter rated current ×1.00
<b>CE103</b> Low-current detection level 2, 1st-motor	Inverter rated current×(0.00~2.00)	Inverter rated current ×1.00

- In the case of low-current, outputs a signal.

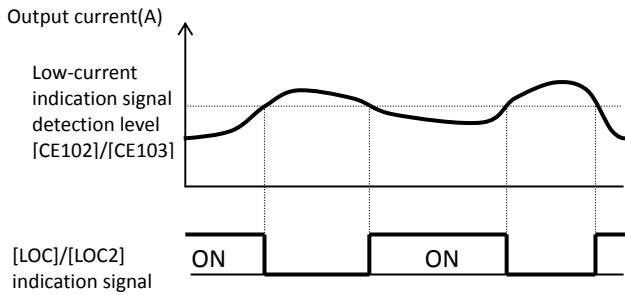

Overload detection signal

Code/Name	Range (unit)	Initial value
<b>CE105</b> Overload warning signal mode selection, 1st-motor	00(During Acc/Decel and constant speed)/ 01(During constant speed only)	01
<b>CE106</b> Overload warning level 1, 1st-motor	Inverter rated current×(0.00~2.00)	Inverter rated current ×1.00
<b>CE107</b> Overload warning level 2, 1st-motor	Inverter rated current×(0.00~2.00)	Inverter rated current ×1.00

- In the case of overload, outputs a signal.

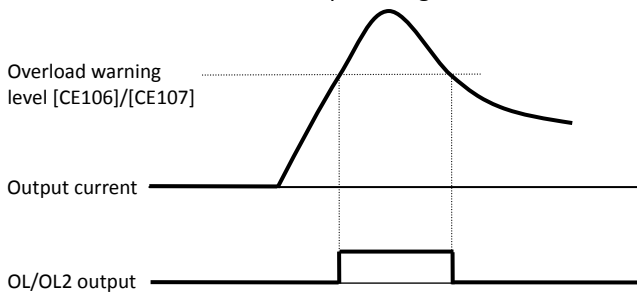

[CE-10]~[CE-31]

Frequency arrival signal

Code/Name	Range (unit)	Initial value
<b>CE-10</b> Arrival frequency for acceleration 1	0.00~ 590.00(Hz)	0.00
<b>CE-11</b> Frequency arrival for deceleration 1		0.00
<b>CE-12</b> Arrival frequency for acceleration 2		0.00
<b>CE-13</b> Frequency arrival for deceleration 2		0.00

- Sets the operation of the arrival signal.

(Example) In FA2/FA4 case:

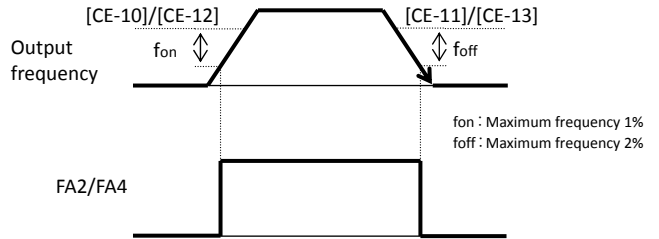

(Example) In FA3/FA5 case:

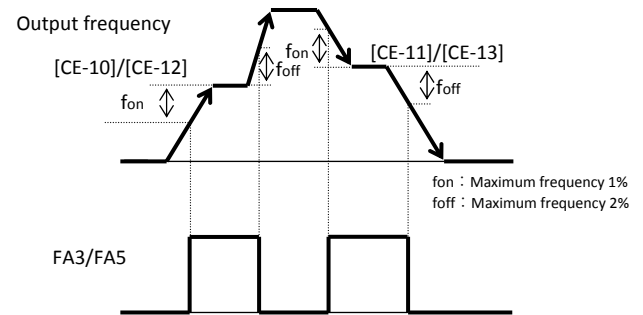

Over-torque signal

Code/Name	Range (unit)	Initial value
<b>CE120</b> Over-torque level (Forward during), 1st-motor	0.0~300.0(%)	100.0
<b>CE121</b> Over-torque level (Reverse driving), 1st-motor		100.0
<b>CE122</b> Over-torque level (Forward regenerative), 1st-motor		100.0
<b>CE123</b> Over-torque level (Forward driving), 1st-motor		100.0

- Sets the level to output the 019[OTQ] signal, when using vector control and the torque goes over the limit.

Electronic thermal warning

Code/Name	Range (unit)	Initial value
<b>CE-30</b> Electronic thermal level (motor)	0.00~	80.00
<b>CE-31</b> Electronic thermal level (inverter)	100.00(%)	80.00

- Sets the level to output the motor electronic thermal warning 026[THM].
- Sets the level to output the inverter electronic thermal warning 027[THC].

[CE-33]~[CE-55]

[CF201]~[CF223]

0Hz speed detection signal

Code/Name	Range (unit)	Initial value
<b>CE-33</b> Zero speed detection level	0.00~100.00(Hz)	0.00

- Sets the level in which the Inverter outputs the 0Hz detection signal 040[ZS]

Cooling fan overheat warning signal

Code/Name	Range (unit)	Initial value
<b>CE-34</b> Cooling fan overheat warning level	0~200(°C)	120

- Sets the level in which outputs the Heat sink overheat warning 032[OHF].

Signals for RUN/ON beyond time

Code/Name	Range (unit)	Initial value
<b>CE-36</b> Accum. RUN(RNT) / Accum.Power-ON(ONT) time setting	0~100000(hour)	0

- Sets the level in which the Inverter outputs the RUN beyond time 024[RNT] and the Power-on beyond time 025[ONT].

Window comparator (detection of terminal disconnection)

	Code/Name	Range (unit)	Initial value
Window comparator	<b>CE-40</b> [Ai1] Upper limit	0~100(%)	100
	<b>CE-41</b> [Ai1] Lower limit	0~100(%)	0
	<b>CE-42</b> [Ai1] Hysteresis width	0~10(%)	0
	<b>CE-43</b> [Ai2] Upper limit	0~100(%)	100
	<b>CE-44</b> [Ai2] Lower limit	0~100(%)	0
	<b>CE-45</b> [Ai2] Hysteresis width	0~10(%)	0
	<b>CE-46</b> [Ai3] Upper limit	-100~100(%)	100
	<b>CE-47</b> [Ai3] Lower limit	-100~100(%)	-100
Disconnection detection	<b>CE-48</b> [Ai3] Hysteresis width	0~10(%)	0
	<b>CE-50</b> [Ai1] Operation level	0~100(%)	0
	<b>CE-51</b> [Ai1] Level enable	00(Disable)/ 01(Inside range)/ 02(Out of range)	00
	<b>CE-52</b> [Ai2] Operation level	0~100(%)	0
	<b>CE-53</b> [Ai2] Level enable	00(Disable)/ 01(Inside range)/ 02(Out of range)	00
	<b>CE-54</b> [Ai3] Operation level	-100~100(%)	0
	<b>CE-55</b> [Ai3] Level enable	00(Disable)/ 01(Inside range)/ 02(Out of range)	00

- Outputs a signal whenever the Analog input value is within or out of range.
- As for disconnection detection, if is within or out of range, a value can be set for the operation.

If [CE-51][CE-53][CE-55]=02

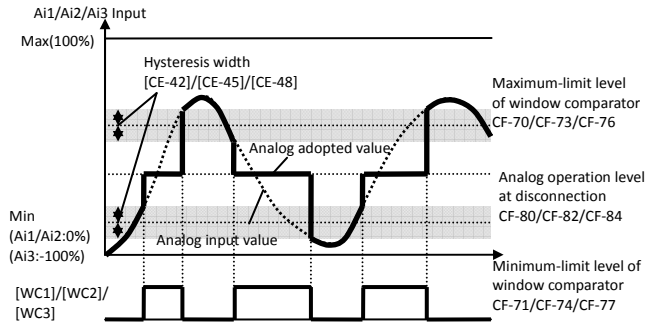

2nd motor When Intelligent Input terminal 024[SET] is enabled.

Code/Name	Range (unit)	Initial value
<b>CE201</b> Low-current indication signal output mode selection, 2nd-motor	Same as CE101	
<b>CE202</b> Low-current detection level 1, 2nd-motor	Same as CE102	
<b>CE203</b> Low-current detection level 2, 2nd-motor	Same as CE103	
<b>CE205</b> Overload warning signal output mode selection, 2nd-motor	Same as CE105	
<b>CE206</b> Overload warning level 1, 2nd-motor	Same as CE106	
<b>CE207</b> Overload warning level 2, 2nd-motor	Same as CE107	
<b>CE220</b> Over-torque level (Reverse regenerative), 2nd-motor	Same as CE120	
<b>CE221</b> Over-torque level (Reverse driving), 2nd-motor	Same as CE121	
<b>CE222</b> Over-torque level (Forward regenerative), 2nd-motor	Same as CE122	
<b>CE223</b> Over-torque level (Forward driving), 2nd-motor	Same as CE123	

## [CF-01]~[CF-10]

## Modbus communication

Code/Name	Range (unit)	Initial value
<b>CF-01</b> RS485 communication baud rate selection	03(2400bps)/ 04(4800bps)/ 05(9600bps)/ 06(19.2kbps)/ 07(38.4kbps)/ 08(57.6kbps)/ 09(76.8kbps)/ 10(115.2kbps)	05
<b>CF-02</b> RS485 communication Node allocation	1~247	1
<b>CF-03</b> RS485 communication parity selection	00(Absent)/ 01(Even parity)/ 02(Odd parity)	00
<b>CF-04</b> RS485 communication stop-bit selection	01(1bit)/02(2bit)	01
<b>CF-05</b> RS485 communication erroort selection	00(Error)/ 01(Tripping after deceleration and stopping the motor)/ 02(Ignore errors)/ 03(Stopping the motor after free-run)/ 04(Deceleration and stopping the motor)	02
<b>CF-06</b> RS485 communication trip limit time setting (timeout)	0.00~100.00(s)	0.00
<b>CF-07</b> RS485 communication wait time	0~1000(ms)	0
<b>CF-08</b> RS485 communication mode selection	01(Modbus-RTU)/ 02(EzCOM)/ 03(EzCOM control)	01

- Sets the Modbus communication function for its use.
- When using communication function between inverter EzCOM, set a value except 01 for [CF-08].

## [CF-20]~[CF-50]

## EzCOM peer to peer communication

Code/Name	Range (unit)	Initial value
<b>CF-20</b> EzCOM Start node No.	01~08	01
<b>CF-21</b> EzCOM End node No.	01~08	01
<b>CF-22</b> EzCOM Start selection	00(Terminal ECOM)/ 01(Always)	00
<b>CF-23</b> EzCOM data size	01~05	05
<b>CF-24</b> EzCOM destination address 1	1~247	1
<b>CF-25</b> EzCOM destination register 1	0000~FFFF	0000
<b>CF-26</b> EzCOM source register 1	0000~FFFF	0000
<b>CF-27</b> EzCOM destination address 2	1~247	2
<b>CF-28</b> EzCOM destination register 2	0000~FFFF	0000
<b>CF-29</b> EzCOM source register 2	0000~FFFF	0000
<b>CF-30</b> EzCOM destination address 3	1~247	3
<b>CF-31</b> EzCOM destination register 3	0000~FFFF	0000
<b>CF-32</b> EzCOM source register 3	0000~FFFF	0000
<b>CF-33</b> EzCOM destination address 4	1~247	4
<b>CF-34</b> EzCOM destination register 4	0000~FFFF	0000
<b>CF-35</b> EzCOM source register 4	0000~FFFF	0000
<b>CF-36</b> EzCOM destination address 5	1~247	5
<b>CF-37</b> EzCOM destination register 5	0000~FFFF	0000
<b>CF-38</b> EzCOM source register 5	0000~FFFF	0000

- Set for the use of EzCOM function.
- For more information, refer to the User's guide.

## USB node code

Code/Name	Range (unit)	Initial value
<b>CF-50</b> USB communication node selection	1~247	1

- Sets the USB code in the case of multiple inverter connections with ProDriveNext(PC software), as is also required in the ProDriveNext side.

[HA-01]~[HA135]

Parameter mode (H code)

Auto-tuning

Code/Name	Range (unit)	Initial value
<b>HA-01</b> Auto-tuning selection	00(Disable)/ 01(No-rotation)/ 02(Rotation)/	00
<b>HA-02</b> RUN command selection at Auto-tuning	00(RUN-key)/ 01(By [AA111]/ and [AA211])	00
<b>HA-03</b> Online auto-tuning selection	00(Disable)/ 01(Enable)	00

- After setting the motor basic parameters, by the auto-tuning operation you can get the constant of the motor.
- For no-rotation auto-tuning, the following variables are acquired, IM:[Hb110]~[Hb114], SM(PMM):[Hd110]~[Hd114].
- For rotation auto-tuning, the following variables are acquired, IM:[Hb110]~[Hb118]. Keep the operation conditions, as the motor can rotate.
- Auto-tuning start is done by the RUN-key ([HA-02] Initial value)
- If [HA-04] is changed, the display unit will change also.

Motor stabilization (Hunting)

Code/Name	Range (unit)	Initial value
<b>HA110</b> Stabilization constant, 1st-motor	0~1000(%)	100

- For hunting in driving pumps or fans, lower the value of the stabilization constant for adjustment.
- In the case that the duty is relatively light, and occurs hunting, increase the stabilization constant.

Control mode response adjustment

Code/Name	Range (unit)	Initial value
<b>HA115</b> Speed response, 1st motor	0~1000(%)	100

- You can adjust the speed response in the operation control of the inverter.
- ⇒[AA121] control mode

[HA140]~[HA154]

Control response gain

Code/Name	Range (unit)	Initial value
<b>HA120</b> ASR gain switching mode selection, 1st-motor	00([CAS] terminal)/ 01(Change set)	00
<b>HA121</b> Gain switching time, 1st-motor	0~10000(ms)	100
<b>HA122</b> ASR gain mapping intermediate speed 1, 1st-motor	0.00~590.00(Hz)	0.00
<b>HA123</b> ASR gain mapping intermediate speed 2, 1st-motor	0.00~590.00(Hz)	0.00
<b>HA124</b> ASR gain mapping Maximum speed, 1st-motor	0.00~590.00(Hz)	0.00
<b>HA125</b> ASR gain mapping P-gain 1, 1st-motor	0.0~1000.0(%)	0.0
<b>HA126</b> ASR gain mapping I-gain 1, 1st-motor	0.0~1000.0(%)	0.0
<b>HA127</b> ASR gain mapping P-gain 1 at P-control, 1st-motor	0.00~10.00	1.00
<b>HA128</b> ASR gain mapping P-gain 2, 1st-motor	0.0~1000.0(%)	100.0
<b>HA129</b> ASR gain mapping I-gain 2, 1st-motor	0.0~1000.0(%)	100.0
<b>HA130</b> ASR gain mapping P-gain 2 at P-control, 1st-motor	0.00~10.00	1.00
<b>HA131</b> ASR gain mapping P-gain 3, 1st-motor	0.0~1000.0(%)	100.0
<b>HA132</b> ASR gain mapping I-gain 3, 1st-motor	0.0~1000.0(%)	100.0
<b>HA133</b> ASR gain mapping P-gain 4, 1st-motor	0.0~1000.0(%)	100.0
<b>HA134</b> ASR gain mapping I-gain 4, 1st-motor	0.0~1000.0(%)	100.0

- Current response of the motor control can be changed.
- In case of [CAS] terminal switching, [HA140]=00

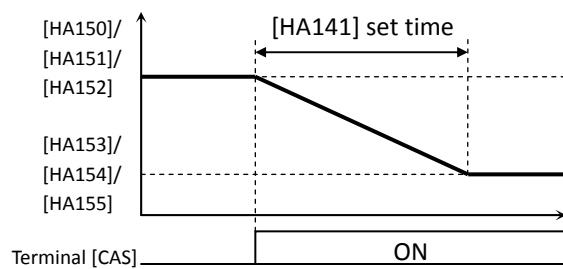

- In case of Control Gain Mapping, [HA140]=01

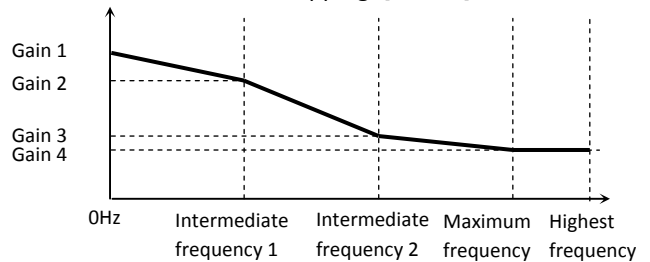

[HA230]~[HA254]

2nd motor When Intelligent Input terminal 024[SET] is enabled.

Code/Name	Range (unit)	Initial value
<b>HA210</b> Stabilization constant, 2nd-motor	0~1000(%)	100
<b>HA215</b> Speed response, 2nd motor	Same as HA115	
<b>HA220</b> ASR gain switching mode selection, 2nd-motor	Same as HA120	
<b>HA221</b> Gain switching time, 2nd-motor	Same as HA121	
<b>HA222</b> ASR gain mapping intermediate speed 1, 2nd-motor	Same as HA122	
<b>HA223</b> ASR gain mapping intermediate speed 2, 2nd-motor	Same as HA123	
<b>HA224</b> ASR gain mapping Maximum speed, 2nd-motor	Same as HA124	
<b>HA225</b> ASR gain mapping P-gain 1, 2nd-motor	Same as HA125	
<b>HA226</b> ASR gain mapping I-gain 1, 2nd-motor	Same as HA126	
<b>HA227</b> ASR gain mapping P-gain 1 at P-control, 2nd-motor	Same as HA127	
<b>HA228</b> ASR gain mapping P-gain 2, 2nd-motor	Same as HA128	
<b>HA229</b> ASR gain mapping I-gain 2, 2nd-motor	Same as HA129	
<b>HA230</b> ASR gain mapping P-gain 2 at P-control, 2nd-motor	Same as HA130	
<b>HA231</b> ASR gain mapping P-gain 3, 2nd-motor	Same as HA131	
<b>HA232</b> ASR gain mapping I-gain 3, 2nd-motor	Same as HA132	
<b>HA233</b> ASR gain mapping P-gain 4, 2nd-motor	Same as HA133	
<b>HA234</b> ASR gain mapping I-gain 4, 2nd-motor	Same as HA134	

[Hb102]~[Hb108]

Basic parameters for Induction motor

Code/Name	Range (unit)	Initial value
<b>Hb102</b> Async. Motor capacity setting, 1st-motor	0.01 ~ 630.00 (kW)	Motor capacity setting
<b>Hb103</b> Async. Motor poles setting, 1st-motor	2~48 (Pole)	4
<b>Hb104</b> Async. Motor Base frequency setting, 1st-motor	10.00 ~ 590.00 (Hz)	60.00(JPN)(USA)/50.00(EU)(ASIA)(CHN)
<b>Hb105</b> Async. Motor Maximum frequency setting, 1st-motor	10.00 ~ 590.00 (Hz)	60.00(JPN)(USA)/50.00(EU)(ASIA)(CHN)
<b>Hb106</b> Async. Motor rated voltage, 1st-motor	1~1000 (V)	(200V Class) 200(JPN) 230(EU)(USA)(ASIA)(CHN) (400V Class) 400(JPN)(EU)(ASIA)(CHN) 460(USA)
<b>Hb108</b> Async. Motor rated current, 1st-motor	0.01~10000.00 (A)	Motor capacity setting

- If the motor capacity [Hb102] and number of poles [Hb103] are changed, the motor characteristics are set according to the internal Hitachi table values.
- The output is decided by setting the frequency and voltage. Below there is an example of V / f control.

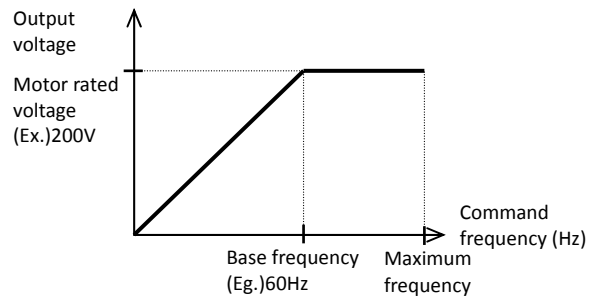

- By setting the motor rated current, a reference current for the motor protection is set.

※Initial value depends on the inverter.

Motor typical data	Code	Range of values (Unit)
Capacity	[Hb102]	0.01~160.00 (kW)
Number of poles	[Hb103]	2~48 (poles)
Frequency	[Hb104]	10.00~590.00 (Hz)
	[Hb105]	10.00~590.00 (Hz)
Voltage	[Hb106]	1~1000 (V)
Current	[Hb108]	0.01~10000.00 (A)

[Hb110]~[Hb131]

Induction motor constants

	Code/Name	Range (unit)	Initial value
Induction Motor (IM)	<b>Hb110</b> Async. Motor constant R1, 1st-motor	0.000001~1000.000000 (Ω)	Motor capacity setting
	<b>Hb112</b> Async. Motor constant R2, 1st-motor	0.000001~1000.000000 (Ω)	Motor capacity setting
	<b>Hb111</b> Async. Motor constant L, 1st-motor	0.000001~1000.000000 (mH)	Motor capacity setting
	<b>Hb116</b> Async. Motor constant I <sub>0</sub> , 1st-motor	0.01~1000.00 (A)	Motor capacity setting
	<b>Hb118</b> Async. Motor constant J, 1st-motor	0.00001~10000.000000 (kgm <sup>2</sup> )	Motor capacity setting

- If the motor capacity[Hb102] and number of poles [Hb103] are changed, the motor characteristics are set according to the internal Hitachi table values.
- For no-rotation auto-tuning, the following variables are acquired:[Hb110]~[Hb114].
- For rotation auto-tuning, the following variables are acquired:[Hb110]~[Hb118]
- It is possible to input the data obtained from the motor manufacturer. However, it must also include the data of the wiring and the like.

Minimum frequency setting

Code/Name	Range (unit)	Initial value
<b>Hb130</b> Minimum frequency, 1st-motor	0.00~10.00(Hz)	0.50
<b>Hb131</b> Reduced voltage start time, 1st-motor	0~2000(ms)	36

- If the torque at the time of start-up is not enough, you can change the settings to raise the lowest frequency.
- Raise the minimum frequency, if the trip occurs, set a longer time of reduced voltage start selection.

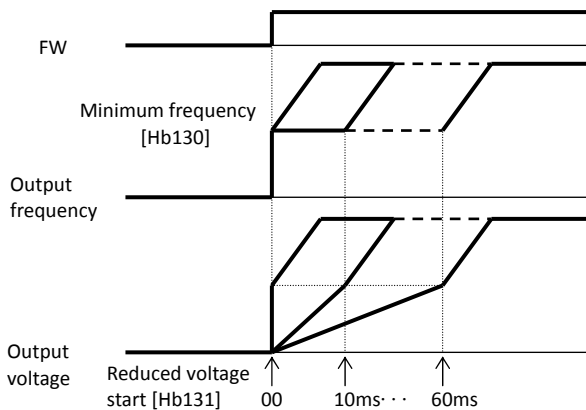

[Hb140]~[Hb146]

Manual torque boost adjustment

Code/Name	Range (unit)	Initial value
<b>Hb140</b> Manual torque boost operational mode selection, 1st-motor	00(Disabled)/01(Enabled)/02(Only forward)/03(Only reverse)	01
<b>Hb141</b> Manual torque boost value, 1st-motor	0.0~20.0(%)	1.0
<b>Hb142</b> Manual torque boost Peak speed, 1st-motor	0.0~50.0(%)	5.0

- In the manual boost operation mode only forward or reverse boost can be selected.
- Example [Hb140]=02

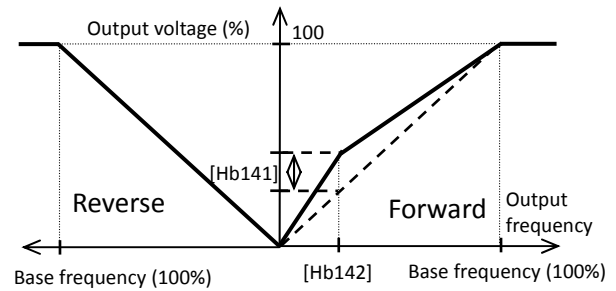

Eco Drive function

Code/Name	Range (unit)	Initial value
<b>Hb145</b> Eco drive enable, 1st-motor	00(Disable)/01(Enable)	00
<b>Hb146</b> Eco drive response adjustment, 1st-motor	0~100(%)	50

- In V/f control, if the energy saving operations is enabled, enters an energy saving control.



[Hb150]~[Hb180]

Free V/f setting

Code/Name	Range (unit)	Initial value
<b>Hb150</b> Free-V/f frequency 1,	0.00~ [Hb152](Hz)	0.00
<b>Hb151</b> Free V/f voltage 1	0.0~1000.0(V)	0.0
<b>Hb152</b> Free V/f frequency 2	[Hb150] ~ [Hb154](Hz)	0.00
<b>Hb153</b> Free V/f voltage 2	0.0~1000.0(V)	0.0
<b>Hb154</b> Free V/f frequency 3	[Hb152] ~ [Hb156](Hz)	0.00
<b>Hb155</b> Free V/f voltage 3	0.0~1000.0(V)	0.0
<b>Hb156</b> Free V/f frequency 4	[Hb154] ~ [Hb158](Hz)	0.00
<b>Hb157</b> Free V/f voltage 4	0.0~1000.0(V)	0.0
<b>Hb158</b> Free V/f frequency 5	[Hb156] ~ [Hb160](Hz)	0.00
<b>Hb159</b> Free V/f voltage 5	0.0~1000.0(V)	0.0
<b>Hb160</b> Free V/f frequency 6	[Hb158] ~ [Hb162](Hz)	0.00
<b>Hb161</b> Free V/f voltage 6	0.0~1000.0(V)	0.0
<b>Hb162</b> Free V/f frequency 7	[Hb160] ~ [Hb164](Hz)	0.00
<b>Hb163</b> Free V/f voltage 7	0.0~1000.0(V)	0.0

- Frequency 1(f1)~frequency (f7) and the corresponding voltage 1(V1)~voltage 7(V7) are set below the base frequency and rated voltage. In the case of a high-frequency motor, set the base/highest frequency the first.

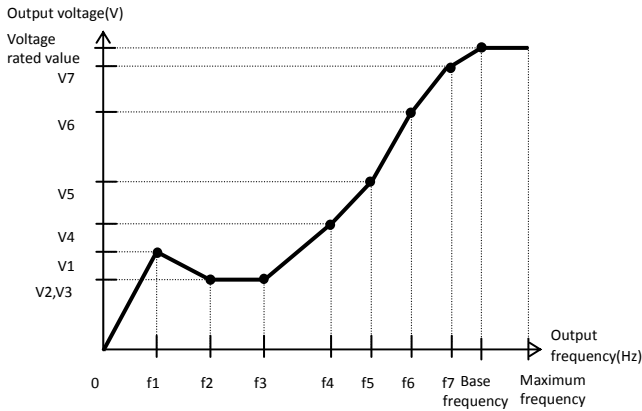

V/f feedback control adjustment

Code/Name	Range (unit)	Initial value
<b>Hb170</b> Slip Compensation P-gain with encoder	0~1000(%)	100
<b>Hb171</b> Slip Compensation I-gain with encoder	0~1000(%)	100

- When [AA121] is set as feedback control, slip compensation is possible.

Output adjustment gain

Code/Name	Range (unit)	Initial value
<b>Hb180</b> Output voltage gain	0~255(%)	100

- When the motor is hunting, you might want to improve the adjustment of the voltage gain.

[Hb202]~[Hb280]

2nd motor When Intelligent Input terminal 024[SET] is enabled.

Code/Name	Range (unit)	Initial value
Induction Motor (IM)	<b>Hb202</b> Capacity selection, 2nd-motor	Same as Hb102
	<b>Hb203</b> Number of poles, 2nd-motor	Same as Hb103
	<b>Hb204</b> Base frequency, 2nd-motor	Same as Hb104
	<b>Hb205</b> Maximum frequency, 2nd-motor	Same as Hb105
	<b>Hb206</b> Rated voltage, 2nd-motor	Same as Hb106
	<b>Hb208</b> Rated current, 2nd-motor	Same as Hb108
	<b>Hb210</b> Constant R1, 2nd-motor	Same as Hb110
	<b>Hb212</b> Constant R2, 2nd-motor	Same as Hb112
	<b>Hb214</b> Constant L, 2nd-motor	Same as Hb114
	<b>Hb216</b> Constant Io, 2nd-motor	Same as Hb116
<b>Hb218</b> Constant J, 2nd-motor	Same as Hb118	

2nd motor When Intelligent Input terminal 024[SET] is enabled.

Code/Name	Range (unit)	Initial value
<b>Hb230</b> Minimum frequency, 2nd-motor	Same as Hb130	
<b>Hb231</b> Reduced voltage start time, 2nd-motor	Same as Hb131	
<b>Hb240</b> Manual torque boost operation mode selection, 2nd-motor	Same as Hb140	
<b>Hb241</b> Manual torque boost value, 2nd-motor	Same as Hb141	
<b>Hb242</b> Manual torque boost peak, 2nd-motor	Same as Hb142	
<b>Hb245</b> Energy saving operation selection, 2nd-motor	Same as Hb145	
<b>Hb246</b> Energy saving mode adjustment, 2nd-motor	Same as Hb146	
<b>Hb250</b> Free V/f frequency (1), 2nd-motor	Same as Hb150	
<b>Hb251</b> Free V/f voltage (1), 2nd-motor	Same as Hb151	
<b>Hb252</b> Free V/f frequency (2), 2nd-motor	Same as Hb152	
<b>Hb253</b> Free V/f voltage (2), 2nd-motor	Same as Hb153	
<b>Hb254</b> Free V/f frequency (3), 2nd-motor	Same as Hb154	
<b>Hb255</b> Free V/f voltage (3), 2nd-motor	Same as Hb155	
<b>Hb256</b> Free V/f frequency (4), 2nd-motor	Same as Hb156	
<b>Hb257</b> Free V/f voltage (4), 2nd-motor	Same as Hb157	
<b>Hb258</b> Free V/f frequency (5), 2nd-motor	Same as Hb158	
<b>Hb259</b> Free V/f voltage (5), 2nd-motor	Same as Hb159	
<b>Hb260</b> Free V/f frequency (6), 2nd-motor	Same as Hb160	
<b>Hb261</b> Free V/f voltage (6), 2nd-motor	Same as Hb161	
<b>Hb262</b> Free V/f frequency (7), 2nd-motor	Same as Hb162	
<b>Hb263</b> Free-setting V/f voltage (7), 2nd-motor	Same as Hb163	
<b>Hb270</b> Slip Compensation P-gain with encoder, 2nd-motor	Same as Hb170	
<b>Hb271</b> Slip Compensation I-gain with encoder, 2nd-motor	Same as Hb171	
<b>Hb280</b> Output voltage gain, 2nd-motor	Same as Hb180	

**[HC101]~[HC121]****Automatic torque boost adjustment**

Code/Name	Range (unit)	Initial value
<b>HC101</b> Automatic torque boost voltage compensation gain, 1st-motor	0~255(%)	100
<b>HC102</b> Automatic torque boost slip compensation gain, 1st-motor	0~255(%)	100

- If is chosen the automatic torque boost control function in [AA121], adjustments can be made. For more information, refer to the user's guide.

**Sensorless vector control start**

Code/Name	Range (unit)	Initial value
<b>HC110</b> Zero speed area limit, 1st-motor	0~100(%)	80
<b>HC111</b> Boost value at start, 1st-motor (IM-SLV,IM-CLV)	0~50(%)	10
<b>HC112</b> Boost value at start, 1st-motor (IM-0Hz-SLV)	0~50(%)	10

- When [AA121] is Sensorless vector control or 0Hz-Area sensor less vector control, start boost is possible.

**Secondary resistor compensation function**

Code/Name	Range (unit)	Initial value
<b>HC113</b> Secondary resistance correction, 1st-motor	00(Disable)/01(Enable)	00

- This control method, in vector control (with encoder/sensorless/0Hz), gets the temperature of the motor, and reduces the speed variation due to temperature change.
- If you want to use this function, use a thermistor PB-41E from Shibaura Electronics(Ltd.) with [Cb-40]=02(NTC).

**Reverse run protection function**

Code/Name	Range (unit)	Initial value
<b>HC114</b> Reverse run protection enable, 1st-motor	00(Disable)/01(Enable)	00

- This function is to prevent reverse output in a low frequency range for vector control such as (SLV/0Hz SLV/CLV)

**Motor control adjustment gain**

Code/Name	Range (unit)	Initial value
<b>HC120</b> Time constant of torque current reference filter, 1st-motor	0~100(ms)	2
<b>HC121</b> Feedforward gain compensation adjustment for speed, 1st-motor	0~1000(%)	0

- [HC120] can put into effect a filter for torque command of sensorless vector control, 0Hz sensorless vector control and vector control with encoder.
- [HC121] adjust the compensation of the feedforward for torque command of sensorless vector control, 0Hz sensorless vector control and vector control with encoder.

**[HC201]~[HC220]**

2nd motor When Intelligent Input terminal 024[SET] is enabled.

Code/Name	Range (unit)	Initial value
<b>HC201</b> Automatic torque boost voltage compensation gain, 2nd-motor	Same as HC101	
<b>HC202</b> Automatic torque boost slip compensation gain, 2nd-motor	Same as HC102	
<b>HC210</b> Zero speed area limit, 2nd-motor	Same as HC110	
<b>HC211</b> Boost value at start, 2nd-motor (IM-SLV,IM-CLV)	Same as HC111	
<b>HC212</b> Boost value at start, 2nd-motor (IM-0Hz-SLV)	Same as HC112	
<b>HC213</b> Secondary resistor compensation enable, 2nd-motor	Same as HC113	
<b>HC214</b> Counter direction run protection selection, 2nd-motor	Same as HC114	
<b>HC220</b> Torque current reference filter time constant, 2nd-motor	Same as HC120	
<b>HC221</b> Speed feedforward compensation gain, 2nd-motor	Same as HC121	

[Hd102]~[Hd118]

(SM/PMM) basic parameters

	Code/Name	Range (unit)	Initial value
Permanent Magnet Sync. Motor(SM/PMM)	<b>Hd102</b> Sync. Motor capacity setting, 1st-motor	0.01~160.00 (kW)	Factory setting
	<b>Hd103</b> Sync. Motor capacity setting, 1st-motor	2~48(Pole)	4
	<b>Hd104</b> Sync. Base frequency setting, 1st-motor	10.00~590.00 (Hz)	60.00(JPN)(USA)/ 50.00(EU)(ASIA)(CHN)
	<b>Hd105</b> Sync. Maximum frequency setting, 1st-motor	10.00~590.00 (Hz)	60.00(JPN)(USA)/ 50.00(EU)(ASIA)(CHN)
	<b>Hd106</b> Sync. Motor rated voltage, 1st-motor	1~1000 (V)	(200V Class) 200(JPN) 230(EU)(USA)(ASIA)(CHN) (400V Class) 400(JPN)(EU)(ASIA)(CHN) 460(USA)
	<b>Hd108</b> Sync. Motor rated current, 1st-motor	0.01~10000.00 (A)	Factory setting

	Code/Name	Range (unit)	Initial value
Permanent Magnet Synchronous Motor (SM/PMM)	<b>Hd110</b> Sync. Motor Constant R, 1st-motor	0.000001~1000.000000 (Ω)	Factory setting
	<b>Hd112</b> Sync. Motor Constant Ld, 1st-motor	0.000001~1000.000000 (mH)	Factory setting
	<b>Hd114</b> Sync. Motor Constant Lq, 1st-motor	0.000001~1000.000000 (mH)	Factory setting
	<b>Hd116</b> Sync. Motor Constant Ke, 1st-motor	0.1~100000.0 (mVs/rad)	Factory setting
	<b>Hd118</b> Sync. Motor Constant J, 1st-motor	0.00001~10000.00000 (kgm2)	Factory setting

- Motor capacity and number of poles will be set by Hitachi characteristics table
- For SM/PMM, frequency, voltage, and the motor characteristics are necessary.
- If the maximum current is decided, sets with a margin the overcurrent detection level [bb160].

Motor typical data	Code	Range of values (unit)
Capacity	[Hd102]	0.01~160.00 (kW)
Number of poles	[Hd103]	2~48 (Poles)
Frequency	[Hd104]	10.00~590.00 (Hz)
	[Hd105]	10.00~590.00 (Hz)
Voltage	[Hd106]	1~1000 (V)
Current	[Hd108]	0.01~10000.00 (A)

※Initial value depends on the inverter.

- If motor capacity [Hd102], number of poles [Hd103] are changed, the motor characteristics are set according to the internal Hitachi table values.
- By auto-tuning at stop, values of [Hd110]~[Hd114] can be acquired.

[Hd130]~[Hd218]

Minimum frequency settings

Code/Name	Range (unit)	Initial value
<b>Hd130</b> Minimum Frequency for Sync.M, 1st-motor	0~50(%)	8
<b>Hd131</b> No-Load current for Sync.M, 1st-motor	0~100(%)	10

- By base frequency[Hd104]×[Hd130], change from Sync. to sensorless is possible.
- By [Hd131], the sensorless vector control no-load current is set.

Magnetic pole position estimation SM(PMM)

Code/Name	Range (unit)	Initial value
<b>Hd132</b> Starting Method for Sync.M, 1st-motor	00(Synchronous)/01(Initial position estimate)	00
<b>Hd133</b> IMPE OV wait number for Sync.M, 1st-motor	0~255	10
<b>Hd134</b> IMPE detect wait number for Sync.M, 1st-motor	0~255	10
<b>Hd135</b> IMPE detect number for Sync.M, 1st-motor	0~255	30
<b>Hd136</b> IMPE voltage gain for Sync.M, 1st-motor	0~200(%)	100
<b>Hd137</b> IMPE Mg-pole position offset, 1st-motor	0~359(°)	0

- By setting [Hd132] to initial position estimate, it will estimate the pole position, for next runs will use the saved position, unless it gets disconnected
- Offset [Hd137] is added at the first start when doing reverse motion.

IVMS setting

Code/	Range(unit)	Initial Value
<b>Hd-41</b> Carrier frequency at IVMS	0.5~16.0(kHz)	2.0
<b>Hd-42</b> Filter gain of current detection at IVMS	0~1000	100
<b>Hd-43</b> VMS P-Gain for speed control, SM(PMM)-IVMS	00,01,02,03	00
<b>Hd-44</b> Open phase switching threshold compensation	00(disable)/01(enable)	00
<b>Hd-45</b> P gain for speed control SM(PMM)-IVMS	0~1000	100
<b>Hd-46</b> I gain for speed control SM(PMM)-IVMS	0~10000	100
<b>Hd-47</b> IVMS Wait time for open phase switching	0~1000	100
<b>Hd-48</b> Limitation of decision about the drive direction, SM(PMM)-IVMS	00(disable)/01(enable)	00
<b>Hd-49</b> open phase voltage detection timing adjustment, SM(PMM)-IVMS	0~1000	10
<b>Hd-50</b> Minimum pulse width adjustment, SM(PMM)-IVMS	0~1000	100
<b>Hd-51</b> IVM threshold current limit	0~255	100
<b>Hd-52</b> IVMS threshold gain	0~255	100

- Above parameters are for adjustment in SM(PMM) driving with IVMS

[Hd202]~[Hd241]

2nd motor When Intelligent Input terminal 024[SET] is enabled.

Code/Name		Range (unit)	Initial value
Perm. Magnet Sync. Motor (SM/PMM)	<b>Hd202</b> Sync. Motor capacity setting, 2nd-motor	Same as Hd102	
	<b>Hd203</b> Sync. Motor poles setting, 2nd-motor	Same as Hd103	
	<b>Hd204</b> Sync. Base frequency setting, 2nd-motor	Same as Hd104	
	<b>Hd205</b> Sync. Maximum frequency setting, 2nd-motor	Same as Hd105	
	<b>Hd206</b> Sync. Motor rated voltage, 2nd-motor	Same as Hd106	
	<b>Hd208</b> Sync. Motor rated current, 2nd-motor	Same as Hd108	
	<b>Hd210</b> Sync. Motor constant R, 2nd-motor	Same as Hd110	
	<b>Hd212</b> Sync. Motor constant Ld, 2nd-motor	Same as Hd112	
	<b>Hd214</b> Sync. Motor constant Lq, 2nd-motor	Same as Hd114	
	<b>Hd216</b> Sync. Motor constant Ke, 2nd-motor	Same as Hd116	
<b>Hd218</b> Sync. Motor constant J, 2nd-motor	Same as Hd118		

2nd motor When Intelligent Input terminal 024[SET] is enabled.

Code/Name	Range (unit)	Initial value
<b>Hd230</b> Minimum Frequency for Sync.M, 2nd-motor	Same as Hd130	
<b>Hd231</b> No-Load current for Sync.M, 2nd-motor	Same as Hd131	
<b>Hd232</b> Starting Method for Sync.M, 2nd-motor	Same as Hd132	
<b>Hd233</b> IMPE OV wait number for Sync.M, 2nd-motor	Same as Hd133	
<b>Hd234</b> IMPE detect wait number for Sync.M, 2nd-motor	Same as Hd134	
<b>Hd235</b> IMPE detect number for Sync.M, 2nd-motor	Same as Hd135	
<b>Hd236</b> IMPE voltage gain for Sync.M, 2nd-motor	Same as Hd136	
<b>Hd237</b> IMPE Mg-pole position offset, 2nd-motor	Same as Hd137	

[oA-10]~[oA-32][ob-01]~[ob-04]

Parameter mode (o code)

- o parameters are displayed by the [UA-11] = 01. This configuration is not necessary except when option is used.
- For more information, refer to the User's guide of the corresponding option.

Optional board error operation

Code/Name		Range (unit)	Initial value
Slot 1	<b>oA-10</b> Operation selection on option card error (SLOT-1)	00(Error)/ 01(Continue operation)	00
	<b>oA-11</b> Communication Watch Dog Timer (SLOT-1)	0.00~100.00(s)	0.00
	<b>oA-12</b> Action selection at communication error (SLOT-1)	00(Error)/ 01(Tripping after decelerating and stopping the motor)/ 02(Ignore error)/ 03(Free-run stop)/ 04(Decelerating and stopping)	00
	<b>oA-13</b> RUN command selection at start up (SLOT-1)	00(Disable)/ 01(Enable)	0.00
Slot 2	<b>oA-20</b> Operation selection on option card error (SLOT-2)	00(Error)/ 01(Continue operation)	00
	<b>oA-21</b> Communication Watch Dog Timer (SLOT-2)	0.00~100.00(s)	0.00
	<b>oA-22</b> Action selection at communication error (SLOT-2)	00(Error)/ 01(Tripping after decelerating and stopping the motor)/ 02(Ignore error)/ 03(Free-run stop)/ 04(Decelerating and stopping)	00
	<b>oA-23</b> RUN command selection at start up (SLOT-2)	00(Disable)/ 01(Enable)	0.00
Slot 3	<b>oA-30</b> Operation selection on option card error (SLOT-3)	00(Error)/ 01(Continue operation)	00
	<b>oA-31</b> Communication Watch Dog Timer (SLOT-3)	0.00~100.00(s)	0.00
	<b>oA-32</b> Action selection at communication error (SLOT-3)	00(Error)/ 01(Tripping after decelerating and stopping the motor)/ 02(Ignore error)/ 03(Free-run stop)/ 04(Decelerating and stopping)	00
	<b>oA-33</b> RUN command selection at start up (SLOT-3)	00(Disable)/ 01(Enable)	0.00

- For more information, refer to the User's guide.

P1-FB Optional board encoder input setting

Code/Name	Range (unit)	Initial value
<b>ob-01</b> Encoder constant setting	0~65535(Pulse)	1024
<b>ob-02</b> Encoder position selection	00(A Phase, Cos lead)/ 01(B Phase, Sin lead)	0
<b>ob-03</b> Motor gear ratio Numerator	1~10000	1
<b>ob-04</b> Motor gear ratio Denominator	1~10000	1

- Sets the encoder to be input into the optional board, and sets the motor gear ratio involved in the feedback of the encoder

[ob-10]~[ob-16] [oE-01]~[oE-27]

**P1-FB Pulse train input terminal setting**

Code/Name		Range (unit)	Initial value
Pulse train input (option)	<b>ob-10</b> Pulse train detection object selection (option)	00(Frequency reference)/ 01(Pulse count)/ 02(Speed feedback: sensor-V/f)	00
	<b>ob-11</b> Mode selection of pulse input (option)	00(90°-phase-shift)/ 01(Forward/reverse operation and direction of rotation)/ 02(Forward/reverse operation with pulse train)	00
Pulse train frequency (option)	<b>ob-12</b> Pulse train frequency scale (option)	0.05~200.0(kHz)	50.0
	<b>ob-13</b> Pulse train filter time constant (option)	0.01~2.00(s)	0.10
	<b>ob-14</b> Pulse train bias value (option)	-100.0~100.0(%)	0.0
	<b>ob-15</b> Pulse train detection high limit (option)	0.0~100.0(%)	100.0
	<b>ob-16</b> Pulse train detection low limit (option)	0.0~100.0(%)	0.0

- Set when using the option feedback.
- For more information, refer to the user's guide of the corresponding option.

**P1-FS Optional safety operation setting**

Code/Name	Range(unit)	Initial value
<b>oC-01</b> Safety option input display selection	00(Warning: with display)/ 01(Warning: without display)	00
<b>oC-10</b> SS1-A deceleration time setting	0.00~3600.00(s)	30.00
<b>oC-12</b> SLS-A deceleration time setting	0.00~3600.00(s)	30.00
<b>oC-14</b> SLS-A Speed upper limit: (Forward)	0.00~590.00(Hz)	0.00
<b>oC-15</b> SLS-A Speed upper limit: (Reverse)	0.00~590.00(Hz)	0.00
<b>oC-16</b> SDI-A deceleration time setting	0.00~3600.00(s)	30.00
<b>oC-18</b> SDI-A limited direction	00(Limit) 01(Invert)	00
<b>oC-20</b> SS1-B deceleration time setting	0.00~3600.00(s)	30.00
<b>oC-22</b> SLS-B deceleration time setting	0.00~3600.00(s)	30.00
<b>oC-24</b> SLS-B Speed upper limit(Forward)	0.00~590.00(Hz)	0.00
<b>oC-25</b> SLS-B Speed upper limit(Reverse)	0.00~590.00(Hz)	0.00
<b>oC-26</b> SDI-B deceleration time	0.00~3600.00(s)	30.00
<b>oC-28</b> SDI-B deceleration time setting	00(Limit) 01(Invert)	00

- For more detail refer to optional board instruction.

**P1-AG Optional analog input setting**

Code/Name		Range (unit)	Initial value
[Ai4] terminal	<b>oE-01</b> Filter time constant of [Ai4]	1~500(ms)	8
	<b>oE-03</b> Start value of [Ai4]	0.00~100.00(%)	0.00
	<b>oE-04</b> End value of [Ai4]	0.00~100.00(%)	100.00
	<b>oE-05</b> Start rate of [Ai4]	0.0~[oE-06](%)	0.0
	<b>oE-06</b> End rate of [Ai4]	[oE-05]~100.0(%)	100.0
	<b>oE-07</b> Start point selection of [Ai4]	[oE-05]~100.0(%)	100.0
	[Ai5] terminal	<b>oE-11</b> Filter time constant of [Ai5]	1~500(ms)
<b>oE-13</b> Start value of [Ai5]		0.00~100.00(%)	0.00
<b>oE-14</b> End value of [Ai5]		0.00~100.00(%)	100.00
<b>oE-15</b> Start rate of [Ai5]		0.0~[oE-16](%)	0.0
<b>oE-16</b> End rate of [Ai5]		[oE-15]~100.0(%)	100.0
<b>oE-17</b> Start point selection of [Ai5]	00(Start value)/ 01(0%)	01	
[Ai6] terminal	<b>oE-21</b> Filter time constant of [Ai6]	1~500(ms)	8
	<b>oE-23</b> Start value of [Ai6]	0.00~100.00(%)	0.00
	<b>oE-24</b> End value of [Ai6]	0.00~100.00(%)	100.00
	<b>oE-25</b> Start rate of [Ai6]	0.0~[oE-26](%)	0.0
	<b>oE-26</b> End rate of [Ai6]	[oE-25]~100.0(%)	100.0

- Regarding the adjustment method of the analog input, please refer to the chapter 3 example of I/O terminals adjustment.

[oE-28]~[oE-49]

**P1-AG Optional analog input adjustment**

Code/Name	Range (unit)	Initial value
<b>oE-28</b> [Ai4] Voltage/Current zero-bias adjustment	-200.00~200.00(%)	0.00
<b>oE-29</b> [Ai4] Voltage/Current gain adjustment	-200.00~200.00(%)	100.00
<b>oE-30</b> [Ai5] Voltage/Current zero-bias adjustment	-200.00~200.00(%)	0.00
<b>oE-31</b> [Ai5] Voltage/Current gain adjustment	-200.00~200.00(%)	100.00
<b>oE-32</b> [Ai6] Voltage zero-bias adjustment	-200.00~200.00(%)	0.00
<b>oE-33</b> [Ai6] Voltage gain adjustment	-200.00~200.00(%)	100.00

- Regarding the adjustment method of the analog input, please refer to the chapter 3 example of I/O terminals adjustment.

## [oE-35]~[oE-49]

## P1-AG Window comparators output condition

	Code/Name	Range (unit)	Initial value
Window Comparator	<b>oE-35</b> Window comparator for [Ai4] higher level	-100~100(%)	100
	<b>oE-36</b> Window comparator for [Ai4] lower level	-100~100(%)	-100
	<b>oE-37</b> Window comparator for [Ai4] hysteresis width	0~10(%)	0
	<b>oE-38</b> Window comparator for [Ai5] higher level	0~100(%)	100
	<b>oE-39</b> Window comparator for [Ai5] lower level	0~100(%)	0
	<b>oE-40</b> Window comparator for [Ai5] hysteresis width	0~10(%)	0
	<b>oE-41</b> Window comparator for [Ai6] higher level	0~100(%)	100
	<b>oE-42</b> Window comparator for [Ai6] lower level	0~100(%)	0
	<b>oE-43</b> Window comparator for [Ai6] hysteresis width	0~10(%)	0
Disconnection detection	<b>oE-44</b> Operation level at [AI4] disconnection	-100~100(%)	0
	<b>oE-45</b> Operation level selection at [AI4] disconnection	00(Disable)/ 01(Out of range)/ 02(Inside range)	00
	<b>oE-46</b> Operation level at [AI5] disconnection	0~100(%)	0
	<b>oE-47</b> Operation level selection at [AI5] disconnection	00(Disable)/ 01(Out of range)/ 02(Inside range)	00
	<b>oE-48</b> Operation level at [AI5] disconnection	0~100(%)	0
	<b>oE-49</b> Operation level selection at [AI5] disconnection	00(Disable)/ 01(Out of range)/ 02(Inside range)	00

- Outputs a signal whenever the analog input value is within or out of range.
- As for disconnection detection, if it is in the case of within or out of the range, a value can be set for the operation command.

## [oE-50]~[oE-70]

## P1-AG Optional analog output adjustment

	Code/Name	Range (unit)	Initial value
	<b>oE-50</b> [Ao3] monitor output selection]	Set monitor code	dA-01
	<b>oE-51</b> [Ao4] monitor output selection		dA-01
	<b>oE-52</b> [Ao5] monitor output selection		dA-01
	<b>oE-56</b> Filter time constant of [Ao3] monitor[Ao3] Data type selection	1~500(ms)	10
	<b>oE-57</b> [Ao3] Data type selection	00(Absolute value)/ 01(Signed value)	00
	<b>oE-58</b> [Ao3] monitor bias adjustment	-100.0~100.0(%)	100.0
	<b>oE-59</b> [Ao3] monitor gain adjustment	-1000.0~1000.0(%)	100.0
	<b>oE-60</b> Output level setting at [Ao3] monitor adjust mode	0.0~300.0(%)	100.0
	<b>oE-61</b> Filter time constant of [Ao4] monitor	1~500(ms)	10
	<b>oE-62</b> [Ao4] Data type selection	00(Absolute value)/ 01(Signed value)	00
	<b>oE-63</b> [Ao4] monitor bias adjustment	-100.0~100.0(%)	100.0
	<b>oE-64</b> [Ao4] monitor gain adjustment	-1000.0~1000.0(%)	100.0
	<b>oE-65</b> Output level setting at [Ao4] monitor adjust mode	0.0~300.0(%)	100.0
	<b>oE-66</b> Filter time constant of [Ao5] monitor	1~500(ms)	10
	<b>oE-67</b> [Ao5] Data type selection	00(Absolute value)/ 01(Signed value)	00
	<b>oE-68</b> [Ao5] monitor bias adjustment	-100.0~100.0(%)	100.0
	<b>oE-69</b> [Ao5] monitor gain adjustment	-1000.0~1000.0(%)	100.0
	<b>oE-70</b> Output level setting at [Ao5] monitor adjust mode	0.0~300.0(%)	100.0

- Regarding the adjustment method of the analog output, please refer to the chapter 3 example of I/O terminals adjustment.

[oH-01]~[oH-11]

**P1-EN Optional Ethernet setting**

Code/Name	Range (unit)	Initial value
<b>oH-01</b> IP-address selection	00(Group 1)/ 01(Group 2)	00
<b>oH-02</b> Communication speed (port-1)	00(Auto-negotiation)/ 01(100M:full duplex)/ 02(100M:half duplex)/	00
<b>oH-03</b> Communication speed (port-2)	03(10M:full duplex)/ 04(10M:half duplex)	00
<b>oH-04</b> Ethernet communication timeout	1~65535(ms)	0000
<b>oH-05</b> Modbus TCP Port No.(IPv4)	502, 1024~65535	502
<b>oH-06</b> Modbus TCP Port No.(IPv6)	502, 1024~65535	502

• For more information, refer to the user's guide.

**P1-PB Optional PROFIBUS setting**

Code/Name	Range (unit)	Initial value
<b>oH-20</b> Profibus Node address	0~125	0
<b>oH-21</b> Profibus clear mode selection	00(Clear)/ 01(Keep last value)	00
<b>oH-22</b> Profibus Map selection	00(PPO)/ 01(Conventional)/ 02(Flexible Mode)	00
<b>oH-23</b> setting enable from profibus master	00(enable)/01(disable)	00
<b>oH-24</b> Telegram group selection	00(Gr.A)/01(Gr.B)/ 02(Gr.C)	00

• Refer to optional instruction for more detail.

[oJ-01]~[oJ-40]

**Optional Interface**

Group A option I/F flexible command

Code/Name	Range (unit)	Initial value
<b>oJ-01</b> Register writing 1 Gr.A	0000~FFFF	0000
<b>oJ-02</b> Register writing 2 Gr.A	0000~FFFF	0000
<b>oJ-03</b> Register writing 3 Gr.A	0000~FFFF	0000
<b>oJ-04</b> Register writing 4 Gr.A	0000~FFFF	0000
<b>oJ-05</b> Register writing 5 Gr.A	0000~FFFF	0000
<b>oJ-06</b> Register writing 6 Gr.A	0000~FFFF	0000
<b>oJ-07</b> Register writing 7 Gr.A	0000~FFFF	0000
<b>oJ-08</b> Register writing 8 Gr.A	0000~FFFF	0000
<b>oJ-09</b> Register writing 9 Gr.A	0000~FFFF	0000
<b>oJ-10</b> Register writing 10 Gr.A	0000~FFFF	0000
<b>oJ-11</b> Register reading 1 Gr.A	0000~FFFF	0000
<b>oJ-12</b> Register reading 2 Gr.A	0000~FFFF	0000
<b>oJ-13</b> Register reading 3 Gr.A	0000~FFFF	0000
<b>oJ-14</b> Register reading 4 Gr.A	0000~FFFF	0000
<b>oJ-15</b> Register reading 5 Gr.A	0000~FFFF	0000
<b>oJ-16</b> Register reading 6 Gr.A	0000~FFFF	0000
<b>oJ-17</b> Register reading 7 Gr.A	0000~FFFF	0000
<b>oJ-18</b> Register reading 8 Gr.A	0000~FFFF	0000
<b>oJ-19</b> Register reading 9 Gr.A	0000~FFFF	0000
<b>oJ-20</b> Register reading 10 Gr.A	0000~FFFF	0000

Group B option I/F flexible command

Code/Name	Range (unit)	Initial value
<b>oJ-21</b> Register writing 1 Gr.B	0000~FFFF	0000
<b>oJ-22</b> Register writing 2 Gr.B	0000~FFFF	0000
<b>oJ-23</b> Register writing 3 Gr.B	0000~FFFF	0000
<b>oJ-24</b> Register writing 4 Gr.B	0000~FFFF	0000
<b>oJ-25</b> Register writing 5 Gr.B	0000~FFFF	0000
<b>oJ-26</b> Register writing 6 Gr.B	0000~FFFF	0000
<b>oJ-27</b> Register writing 7 Gr.B	0000~FFFF	0000
<b>oJ-28</b> Register writing 8 Gr.B	0000~FFFF	0000
<b>oJ-29</b> Register writing 9 Gr.B	0000~FFFF	0000
<b>oJ-30</b> Register writing 10 Gr.B	0000~FFFF	0000
<b>oJ-31</b> Register reading 1 Gr.B	0000~FFFF	0000
<b>oJ-32</b> Register reading 2 Gr.B	0000~FFFF	0000
<b>oJ-33</b> Register reading 3 Gr.B	0000~FFFF	0000
<b>oJ-34</b> Register reading 4 Gr.B	0000~FFFF	0000
<b>oJ-35</b> Register reading 5 Gr.B	0000~FFFF	0000
<b>oJ-36</b> Register reading 6 Gr.B	0000~FFFF	0000
<b>oJ-37</b> Register reading 7 Gr.B	0000~FFFF	0000
<b>oJ-38</b> Register reading 8 Gr.B	0000~FFFF	0000
<b>oJ-39</b> Register reading 9 Gr.B	0000~FFFF	0000
<b>oJ-40</b> Register reading 10 Gr.B	0000~FFFF	0000

## [oJ-41]~[oH-60]

## [oL-01]~[oL-36]

Group C option I/F flexible command

Code/Name	Range (unit)	Initial value
<b>oJ-41</b> Register writing 1 Gr. C	0000~FFFF	0000
<b>oJ-42</b> Register writing 2 Gr. C	0000~FFFF	0000
<b>oJ-43</b> Register writing 3 Gr. C	0000~FFFF	0000
<b>oJ-44</b> Register writing 4 Gr. C	0000~FFFF	0000
<b>oJ-45</b> Register writing 5 Gr. C	0000~FFFF	0000
<b>oJ-46</b> Register writing 6 Gr. C	0000~FFFF	0000
<b>oJ-47</b> Register writing 7 Gr. C	0000~FFFF	0000
<b>oJ-48</b> Register writing 8 Gr. C	0000~FFFF	0000
<b>oJ-49</b> Register writing 9 Gr. C	0000~FFFF	0000
<b>oJ-50</b> Register writing 10 Gr. C	0000~FFFF	0000
<b>oJ-51</b> Register reading 1 Gr. C	0000~FFFF	0000
<b>oJ-52</b> Register reading 2 Gr. C	0000~FFFF	0000
<b>oJ-53</b> Register reading 3 Gr. C	0000~FFFF	0000
<b>oJ-54</b> Register reading 4 Gr. C	0000~FFFF	0000
<b>oJ-55</b> Register reading 5 Gr. C	0000~FFFF	0000
<b>oJ-56</b> Register reading 6 Gr. C	0000~FFFF	0000
<b>oJ-57</b> Register reading 7 Gr. C	0000~FFFF	0000
<b>oJ-58</b> Register reading 8 Gr. C	0000~FFFF	0000
<b>oJ-59</b> Register reading 9 Gr. C	0000~FFFF	0000
<b>oJ-60</b> Register reading 10 Gr. C	0000~FFFF	0000

- For more information, refer to the user's guide of the corresponding option.

Code/Name	Range (unit)	Initial value
<b>oL-01</b> IPv4 IP-address (1) Gr.1	0~255	0
<b>oL-02</b> IPv4 IP-address (2) Gr.1	0~255	0
<b>oL-03</b> IPv4 IP-address (3) Gr.1	0~255	0
<b>oL-04</b> IPv4 IP-address (4) Gr.1	0~255	0
<b>oL-05</b> IPv4 sub-net mask (1) Gr.1	0~255	0
<b>oL-06</b> IPv4 sub-net mask (2) Gr.1	0~255	0
<b>oL-07</b> IPv4 sub-net mask (3) Gr.1	0~255	0
<b>oL-08</b> IPv4 sub-net mask (4) Gr.1	0~255	0
<b>oL-09</b> IPv4 default gateway (1) Gr.1	0~255	0
<b>oL-10</b> IPv4 default gateway (2) Gr.1	0~255	0
<b>oL-11</b> IPv4 default gateway (3) Gr.1	0~255	0
<b>oL-12</b> IPv4 default gateway (4) Gr.1	0~255	0
<b>oL-20</b> IPv6 IP-address (1) Gr.1	0000~FFFF	0000
<b>oL-21</b> IPv6 IP-address (2) Gr.1	0000~FFFF	0000
<b>oL-22</b> IPv6 IP-address (3) Gr.1	0000~FFFF	0000
<b>oL-23</b> IPv6 IP-address (4) Gr.1	0000~FFFF	0000
<b>oL-24</b> IPv6 IP-address (5) Gr.1	0000~FFFF	0000
<b>oL-25</b> IPv6 IP-address (6) Gr.1	0000~FFFF	0000
<b>oL-26</b> IPv6 IP-address (7) Gr.1	0000~FFFF	0000
<b>oL-27</b> IPv6 IP-address (8) Gr.1	0000~FFFF	0000
<b>oL-28</b> IPv6 Sub-net prefix Gr.1	0~127	0
<b>oL-29</b> IPv6 default gateway (1) Gr.1	0000~FFFF	0000
<b>oL-30</b> IPv6 default gateway (2) Gr.1	0000~FFFF	0000
<b>oL-31</b> IPv6 default gateway (3) Gr.1	0000~FFFF	0000
<b>oL-32</b> IPv6 default gateway (4) Gr.1	0000~FFFF	0000
<b>oL-33</b> IPv6 default gateway (5) Gr.1	0000~FFFF	0000
<b>oL-34</b> IPv6 default gateway (6) Gr.1	0000~FFFF	0000
<b>oL-35</b> IPv6 default gateway (7) Gr.1	0000~FFFF	0000
<b>oL-36</b> IPv6 default gateway (8) Gr.1	0000~FFFF	0000

- For more information, refer to the user's guide of the corresponding option



## [oL-40]~[oL-76]

	Code/Name	Range (unit)	Initial value
Group 2 IPv4	<b>oL-40</b> IPv4 IP-address (1) Gr.2	0~255	0
	<b>oL-41</b> IPv4 IP-address (2) Gr.2	0~255	0
	<b>oL-42</b> IPv4 IP-address (3) Gr.2	0~255	0
	<b>oL-43</b> IPv4 IP-address (4) Gr.2	0~255	0
	<b>oL-44</b> IPv4 sub-net mask (1) Gr.2	0~255	0
	<b>oL-45</b> IPv4 sub-net mask (2) Gr.2	0~255	0
	<b>oL-46</b> IPv4 sub-net mask (3) Gr.2	0~255	0
	<b>oL-47</b> IPv4 sub-net mask (4) Gr.2	0~255	0
	<b>oL-48</b> IPv4 default gateway (1) Gr.2	0~255	0
	<b>oL-49</b> IPv4 default gateway (2) Gr.2	0~255	0
	<b>oL-50</b> IPv4 default gateway (3) Gr.2	0~255	0
	<b>oL-51</b> IPv4 default gateway (4) Gr.2	0~255	0
Group 2 IPv6	<b>oL-60</b> IPv6 IP-address (1) Gr.2	0000~FFFF	0000
	<b>oL-61</b> IPv6 IP-address (2) Gr.2	0000~FFFF	0000
	<b>oL-62</b> IPv6 IP-address (3) Gr.2	0000~FFFF	0000
	<b>oL-63</b> IPv6 IP-address (4) Gr.2	0000~FFFF	0000
	<b>oL-64</b> IPv6 IP-address (5) Gr.2	0000~FFFF	0000
	<b>oL-65</b> IPv6 IP-address (6) Gr.2	0000~FFFF	0000
	<b>oL-66</b> IPv6 IP-address (7) Gr.2	0000~FFFF	0000
	<b>oL-67</b> IPv6 IP-address (8) Gr.2	0000~FFFF	0000
	<b>oL-68</b> IPv6 Sub-net prefix Gr.2	0~127	0
	<b>oL-69</b> IPv6 default gateway (1) Gr.2	0000~FFFF	0000
	<b>oL-70</b> IPv6 default gateway (2) Gr.2	0000~FFFF	0000
	<b>oL-71</b> IPv6 default gateway (3) Gr.2	0000~FFFF	0000
	<b>oL-72</b> IPv6 default gateway (4) Gr.2	0000~FFFF	0000
	<b>oL-73</b> IPv6 default gateway (5) Gr.2	0000~FFFF	0000
	<b>oL-74</b> IPv6 default gateway (6) Gr.2	0000~FFFF	0000
<b>oL-75</b> IPv6 default gateway (7) Gr.2	0000~FFFF	0000	
<b>oL-76</b> IPv6 default gateway (8) Gr.2	0000~FFFF	0000	

- For more information, refer to the user's guide of the corresponding option

[PA-01]~[PA-09]

[PA-20]~[PA-29]

■Parameter mode (P code)

**Em-force mode settings**

	Code/Name	Range (unit)	Initial value
Em-force mode	<b>PA-01</b> Mode selection for emergency force drive	00(Disable)/01(Enable)	00
	<b>PA-02</b> Frequency reference setting oat emergency force drive	00(Speed control)/01(PID control)	00
	<b>PA-03</b> Direction command at Emergency-force drive	0.00~590.00(Hz)	0.00
Bypass mode	<b>PA-04</b> Commercial power supply bypass function selection	00(Disable)/01(Enable)	00
	<b>PA-05</b> Delay time of bypass function	0.0~1000.0(s)	5.0

- Settings for EM-force in case of abnormality.  
For more information, refer to the user's guide.

**Simulation mode settings**

	Code/Name	Range (unit)	Initial value
	<b>PA-20</b> Simulation mode enable	00(Disable)/01(Enable)	00
	<b>PA-21</b> Error code selection for Alarm test	001~255	000
	<b>PA-22</b> Output current monitor optional output enable	00(Disable)/01(Enable:[Ai1])/02(Enable:[Ai2])/03(Enable:[Ai3])/04(Enable:[Ai4])/05(Enable:[Ai5])/06(Enable:[Ai6])/09(Enable:[PA-23])	01
	<b>PA-23</b> Output current monitor optional output value setting	0.0~300.0(%)	0.0
	<b>PA-24</b> DC-bus voltage monitor optional output value selection	00(Disable)/01(Enable:[Ai1])/02(Enable:[Ai2])/03(Enable:[Ai3])/04(Enable:[Ai4])/05(Enable:[Ai5])/06(Enable:[Ai6])/09(Enable:[PA-25])	00
	<b>PA-25</b> DC voltage monitor optional output value	0.0~300.0(%)	0.0
	<b>PA-26</b> Output voltage monitor optional output enable	00(Disable)/01(Enable:[Ai1])/02(Enable:[Ai2])/03(Enable:[Ai3])/04(Enable:[Ai4])/05(Enable:[Ai5])/06(Enable:[Ai6])/09(Enable:[PA-27])	00
	<b>PA-27</b> Output voltage monitor optional output value setting	0.0~300.0(%)	0.0
	<b>PA-28</b> Output torque monitor optional output enable	00(Disable)/01(Enable:[Ai1])/02(Enable:[Ai2])/03(Enable:[Ai3])/04(Enable:[Ai4])/05(Enable:[Ai5])/06(Enable:[Ai6])/09(Enable:[PA-29])	00
	<b>PA-29</b> Output torque monitor optional output value setting	0.0~300.0(%)	0.0
	<b>PA-30</b> Start with frequency matching optional setting enable	00(Disable)/01(Enable: from Keypad)/02(Enable: from [Ai1])/03(Enable: from [Ai2])/04(Enable: from [Ai3])	01
	<b>PA-31</b> Start with frequency matching optional value setting	-500.0~500.0(%)	0.0

- These are the simulation function settings.  
For more information, refer to the user's guide.

[UA-01]~[UA-19]

■Parameter mode (U code)

**Password setting**

Code/Name	Range (unit)	Initial value
<b>UA-01</b> Password for display	0000~FFFF	0000
<b>UA-02</b> Password for softlock	0000~FFFF	0000

- When using the password, display and parameter mode settings are locked
- The inverter will be locked by password when setting any value other than 0000. The password can be cancelled by entering the set password. Please note that, the restrictions will not be cancelled if you forget the password.

**Display mode of keypad**

Code/Name	Range (unit)	Initial value
<b>UA-10</b> Display restriction selection	00(Full display)/ 01(Function-specific display)/ 02(User setting)/ 03(Data comparison display)/ 04(Monitor only)	00

- Limit the displayed contents of the keypad.
- For more information, refer to the User's guide.

**Accumulated power display adjustment/clear**

Code/Name	Range (unit)	Initial value
<b>UA-12</b> Accumulation output power monitor clear	00(Disable)/ 01(Clear)	00
<b>UA-13</b> Display gain for accumulation input power monitor	1~1000	1
<b>UA-14</b> Accumulation output power monitor clear	00(Disable)/ 01(Clear)	00
<b>UA-15</b> Display gain for accumulation output power monitor	1~1000	1

- If [KHC] terminal is ON, the accumulated input power can be clear.
- If [OKHC] terminal is ON, the accumulated output power can be clear.

**Software lock operation settings**

Code/Name	Range (unit)	Initial value
<b>UA-16</b> Soft-Lock selection	00([SFT] terminal)/ 01(Always enable)	00
<b>UA-17</b> Soft-Lock target selection	00(All data)/ 01(All, except speed )	00

- Sets the software lock operation.

**Keypad copy function restriction**

Code/Name	Range (unit)	Initial value
<b>UA-18</b> Data R/W selection	00(Not able to R/W) 01(Able to R/W)	00

- Restricts the copy function(Read/Write).

**Keypad low battery warning**

Code/Name	Range (unit)	Initial value
<b>UA-19</b> Low battery warning enable	01(Warning)/02(Error)	01

- Sets operation for when keypad is low on battery.

[UA-20]~[UA-62]

**Keypad communication lost operation**

Code/Name	Range (unit)	Initial value
<b>UA-20</b> Operation selection when keypad communication is lost	00(Error)/ 01(Error after deceleration stop)/ 02(Ignore)/ 03(Free-run)/ 04(Deceleration stop)	02

**User-parameter setting function**

Code/Name	Range (unit)	Initial value
<b>UA-30</b> User-parameter auto setting function enable	00(Disable)/ 01(Enable)	00
<b>UA-31</b> User-parameter 1 selection	no/ (parameter)	no
<b>UA-32</b> User-parameter 2 selection		no
<b>UA-33</b> User-parameter 3 selection		no
<b>UA-34</b> User-parameter 4 selection		no
<b>UA-35</b> User-parameter 5 selection		no
<b>UA-36</b> User-parameter 6 selection		no
<b>UA-37</b> User-parameter 7 selection		no
<b>UA-38</b> User-parameter 8 selection		no
<b>UA-39</b> User-parameter 9 selection		no
<b>UA-40</b> User-parameter 10 selection		no
<b>UA-41</b> User-parameter 11 selection		no
<b>UA-42</b> User-parameter 12 selection		no
<b>UA-43</b> User-parameter 13 selection		no
<b>UA-44</b> User-parameter 14 selection		no
<b>UA-45</b> User-parameter 15 selection		no
<b>UA-46</b> User-parameter 16 selection		no
<b>UA-47</b> User-parameter 17 selection		no
<b>UA-48</b> User-parameter 18 selection		no
<b>UA-49</b> User-parameter 19 selection		no
<b>UA-50</b> User-parameter 20 selection		no
<b>UA-51</b> User-parameter 21 selection		no
<b>UA-52</b> User-parameter 22 selection		no
<b>UA-53</b> User-parameter 23 selection		no
<b>UA-54</b> User-parameter 24 selection		no
<b>UA-55</b> User-parameter 25 selection		no
<b>UA-56</b> User-parameter 26 selection		no
<b>UA-57</b> User-parameter 27 selection		no
<b>UA-58</b> User-parameter 28 selection		no
<b>UA-59</b> User-parameter 29 selection		no
<b>UA-60</b> User-parameter 30 selection		no
<b>UA-61</b> User-parameter 31 selection		no
<b>UA-62</b> User-parameter 32 selection		no

- Sets the data displayed when [UA-10]=02.

[UA-90]~[UA-94][Ub-01]~[Ub-04]

**Unit selection**

Code/Name	Range (unit)	Initial value
<b>UA-90</b> QOP indication off waiting time	0~60(s)	10
<b>UA-91</b> Initial display selection	(Select from d, f parameters)	dA-01
<b>UA-92</b> auto return to initial display enable	00(Disable)/01(Enable)	00
<b>UA-93</b> Setting enable at monitor display	00(Disable)/01(Enable)	00
<b>UA-94</b> Multispeed change on the frequency reference monitor display	00(Disable)/01(Enable)	00

- Setting parameter for QOP keypad. Refer to QOP instruction for more detail.

**Initialize**

Code/Name	Range (unit)	Initial value
<b>Ub-01</b> Initialize mode selection	00(Disable)/01(Error history clear)/02(Initialize parameter)/03(Error history clear + initialize parameter)/04(Error history clear + initialize Parameter + EzSQ clear)/05(Except terminal configuration)/06(Except communication configuration)/07(Except terminal & communication configuration)	00
<b>Ub-02</b> Initialize data selection	00(JP)/01(EU)/02(US)/03(AS)/04(CH1)/05(CH2)	00(JPN) 01(EU) 02(USA) 03(CHN)
<b>Ub-03</b> Load type selection	00(VLD)/01(LD)/02(ND)	02
<b>Ub-05</b> Initialize enable	00(Disable)/01(Execute initialization)	00

- To initialize; after setting [Ub-01], setting [Ub-05]=01 will start the initialize process.
- Once setting the load type selection [Ub-03], will change instantaneously the inverter load rating.

**Factory settings**

Code/Name	Range (unit)	Initial value
<b>UC-01</b> (-)	(Do not change)	(00)

[Ud-01]~[Ud-37]

**Trace function**

Code/Name	Range (unit)	Initial value
<b>Ud-01</b> Trace function enable	00(Disable)/01(Enable)	00
<b>Ud-02</b> Trace start	00(Stop)/01(Start)	00
<b>Ud-03</b> Trace data number selection	1~8	1
<b>Ud-04</b> Trace signal number setting	1~8	1
<b>Ud-10</b> Trace data 0 selection	(All the parameters of the monitor mode)	dA-01
<b>Ud-11</b> Trace data 1 selection		dA-01
<b>Ud-12</b> Trace data 2 selection		dA-01
<b>Ud-13</b> Trace data 3 selection		dA-01
<b>Ud-14</b> Trace data 4 selection		dA-01
<b>Ud-15</b> Trace data 5 selection		dA-01
<b>Ud-16</b> Trace data 6 selection		dA-01
<b>Ud-17</b> Trace data 7 selection		dA-01
<b>Ud-20</b> Trace signal 0 Input/Output selection	00(Input)/01(Output)	00
<b>Ud-21</b> Trace signal 0 input terminal selection	Same as [CA-01]	001
<b>Ud-22</b> Trace signal 0 output terminal selection	Same as [CC-01]	001
<b>Ud-23</b> Trace signal 1 Input/Output selection	00(Input)/01(Output)	00
<b>Ud-24</b> Trace signal 1 input terminal selection	Same as [CA-01]	001
<b>Ud-25</b> Trace signal 1 output terminal selection	Same as [CC-01]	001
<b>Ud-26</b> Trace signal 2 Input/Output selection	00(Input)/01(Output)	00
<b>Ud-27</b> Trace signal 2 input terminal selection	Same as [CA-01]	001
<b>Ud-28</b> Trace signal 2 output terminal selection	Same as [CC-01]	001
<b>Ud-29</b> Trace signal 3 Input/Output selection	00(Input)/01(Output)	00
<b>Ud-30</b> Trace signal 3 input terminal selection	Same as [CA-01]	001
<b>Ud-31</b> Trace signal 3 output terminal selection	Same as [CC-01]	001
<b>Ud-32</b> Trace signal 4 Input/Output selection	00(Input)/01(Output)	00
<b>Ud-33</b> Trace signal 4 input terminal selection	Same as [CA-01]	001
<b>Ud-34</b> Trace signal 4 output terminal selection	Same as [CC-01]	001
<b>Ud-35</b> Trace signal 5 Input/Output selection	00(Input)/01(Output)	00
<b>Ud-36</b> Trace signal 5 input terminal selection	Same as [CA-01]	001
<b>Ud-37</b> Trace signal 5 output terminal selection	Same as [CC-01]	001

- Trace function settings.  
For more information, refer to the user's guide.

## [Ud-38]~[Ud-60]

Code/Name	Range (unit)	Initial value
<b>Ud-38</b> Trace signal 6 Input/Output selection	00 (Input: [Ud-39])/01 (Output: [Ud-40])	00
<b>Ud-39</b> Trace signal 6 Input terminal selection	Similar to [CA-01]	001
<b>Ud-40</b> Trace signal 6 Output terminal selection	Similar to [CC-01]	001
<b>Ud-41</b> Trace signal 6 Input/Output selection	00 (Input: [Ud-39])/01 (Output: [Ud-40])	00
<b>Ud-42</b> Trace signal 7 Input terminal selection	Similar to [CA-01]	001
<b>Ud-43</b> Trace signal 7 Output terminal selection	Similar to [CC-01]	001
<b>Ud-50</b> Trace trigger 1 selection	*1)	00
<b>Ud-51</b> Trigger 1 operation selection at trace data trigger	00(Rising edge)/01(Falling edge)	00
<b>Ud-52</b> Trigger 1 level at trace data trigger	0~100(%)	0
<b>Ud-53</b> Trigger 1 operation selection at trace signal trigger	00(Signal ON)/01(Signal OFF)	00
<b>Ud-54</b> Trace trigger 2 selection	*1)	00
<b>Ud-55</b> Trigger 2 operation selection at trace data trigger	00(Rising edge)/01(Falling edge)	00
<b>Ud-56</b> Trigger 2 level at trace data trigger	0~100(%)	0
<b>Ud-57</b> Trigger 2 operation selection at trace signal trigger	00(Signal ON)/01(Signal OFF)	00
<b>Ud-58</b> Trigger condition selection	00(Only trigger 1)/01(Only trigger 2)/02(Trigger 1 OR 2)/03(Trigger 1 AND 2)	00
<b>Ud-59</b> Trigger point setting	0~100(%)	0
<b>Ud-60</b> Sampling time setting	01(0.2ms)/02(0.5ms)/03(1ms)/04(2ms)/05(5ms)/06(10ms)/07(50ms)/08(100ms)/09(500ms)/10(1000ms)	03

\*1) 00(Trip)/01(Data 0)/02(Data 1)/03(Data 2)/04(Data 3)/05(Data 4)/06(Data 5)/07(Data 6)/08(Data 7)/09(Signal 0)/10(Signal 1)/11(Signal 2)/12(Signal 3)/13(Signal 4)/14(Signal 5)/15(Signal 6)/16(Signal 7)

- Trace function settings.

For more information, refer to the user's guide.

## [UE-01]~[UE-48]

## EzSQ

Code/Name	Range (unit)	Initial value
<b>UE-01</b> EzSQ execution timing	00(1ms)/01(2ms: SJ700/L700 compatible)	00
<b>UE-02</b> EzSQ function selection	00(Disable)/01([PRG] terminal)/02(Always-on)	00

- Operates the EzSQ function. For EzSQ is required to download the program.

Code/Name	Range (unit)	Initial value
<b>UE-10</b> U(00)	0~65535	0
<b>UE-11</b> U(01)	0~65535	0
<b>UE-12</b> U(02)	0~65535	0
<b>UE-13</b> U(03)	0~65535	0
<b>UE-14</b> U(04)	0~65535	0
<b>UE-15</b> U(05)	0~65535	0
<b>UE-16</b> U(06)	0~65535	0
<b>UE-17</b> U(07)	0~65535	0
<b>UE-18</b> U(08)	0~65535	0
<b>UE-19</b> U(09)	0~65535	0
<b>UE-20</b> U(10)	0~65535	0
<b>UE-21</b> U(11)	0~65535	0
<b>UE-22</b> U(12)	0~65535	0
<b>UE-23</b> U(13)	0~65535	0
<b>UE-24</b> U(14)	0~65535	0
<b>UE-25</b> U(15)	0~65535	0
<b>UE-26</b> U(16)	0~65535	0
<b>UE-27</b> U(17)	0~65535	0
<b>UE-28</b> U(18)	0~65535	0
<b>UE-29</b> U(19)	0~65535	0
<b>UE-30</b> U(20)	0~65535	0
<b>UE-31</b> U(21)	0~65535	0
<b>UE-32</b> U(22)	0~65535	0
<b>UE-33</b> U(23)	0~65535	0
<b>UE-34</b> U(24)	0~65535	0
<b>UE-35</b> U(25)	0~65535	0
<b>UE-36</b> U(26)	0~65535	0
<b>UE-37</b> U(27)	0~65535	0
<b>UE-38</b> U(28)	0~65535	0
<b>UE-39</b> U(29)	0~65535	0
<b>UE-40</b> U(30)	0~65535	0
<b>UE-41</b> U(31)	0~65535	0
<b>UE-42</b> U(32)	0~65535	0
<b>UE-43</b> U(33)	0~65535	0
<b>UE-44</b> U(34)	0~65535	0
<b>UE-45</b> U(35)	0~65535	0
<b>UE-46</b> U(36)	0~65535	0
<b>UE-47</b> U(37)	0~65535	0
<b>UE-48</b> U(38)	0~65535	0

EzSQ User-parameter U

## [UE-49]~[UF-30]

## [Unit table]

Code/Name		Range (unit)	Initial value
EzSQ User-parameter U	<b>UE-49</b> U(39)	0~65535	0
	<b>UE-50</b> U(40)	0~65535	0
	<b>UE-51</b> U(41)	0~65535	0
	<b>UE-52</b> U(42)	0~65535	0
	<b>UE-53</b> U(43)	0~65535	0
	<b>UE-54</b> U(44)	0~65535	0
	<b>UE-55</b> U(45)	0~65535	0
	<b>UE-56</b> U(46)	0~65535	0
	<b>UE-57</b> U(47)	0~65535	0
	<b>UE-58</b> U(48)	0~65535	0
	<b>UE-59</b> U(49)	0~65535	0
	<b>UE-60</b> U(50)	0~65535	0
	<b>UE-61</b> U(51)	0~65535	0
	<b>UE-62</b> U(52)	0~65535	0
	<b>UE-63</b> U(53)	0~65535	0
	<b>UE-64</b> U(54)	0~65535	0
	<b>UE-65</b> U(55)	0~65535	0
	<b>UE-66</b> U(56)	0~65535	0
	<b>UE-67</b> U(57)	0~65535	0
	<b>UE-68</b> U(58)	0~65535	0
<b>UE-69</b> U(59)	0~65535	0	
<b>UE-70</b> U(60)	0~65535	0	
<b>UE-71</b> U(61)	0~65535	0	
<b>UE-72</b> U(62)	0~65535	0	
<b>UE-73</b> U(63)	0~65535	0	

- EzSQ up to 16 bits data can be set.

Code/Name		Range (unit)	Initial value
EzSQ User-parameter UL	<b>UF-02</b> UL(00)	-2147483647~2147483647	0
	<b>UF-04</b> UL(01)	-2147483647~2147483647	0
	<b>UF-06</b> UL(05)	-2147483647~2147483647	0
	<b>UF-08</b> UL(03)	-2147483647~2147483647	0
	<b>UF-10</b> UL(04)	-2147483647~2147483647	0
	<b>UF-12</b> UL(05)	-2147483647~2147483647	0
	<b>UF-14</b> UL(06)	-2147483647~2147483647	0
	<b>UF-16</b> UL(07)	-2147483647~2147483647	0
	<b>UF-18</b> UL(08)	-2147483647~2147483647	0
	<b>UF-20</b> UL(09)	-2147483647~2147483647	0
	<b>UF-22</b> UL(10)	-2147483647~2147483647	0
	<b>UF-24</b> UL(11)	-2147483647~2147483647	0
	<b>UF-26</b> UL(12)	-2147483647~2147483647	0
	<b>UF-28</b> UL(13)	-2147483647~2147483647	0
	<b>UF-30</b> UL(14)	-2147483647~2147483647	0
<b>UF-32</b> UL(15)	-2147483647~2147483647	0	

- EzSQ up to 32 bits data can be set.

Number	Unit
00	non
01	%
02	A
03	Hz
04	V
05	kW
06	W
07	hr
08	s
09	kHz
10	ohm
11	mA
12	ms
13	P
14	kgm <sup>2</sup>
15	pls
16	mH
17	Vdc
18	°C
19	kWh
20	mF
21	mVs/rad
22	Nm
23	min <sup>-1</sup>
24	m/s
25	m/min
26	m/h
27	ft/s
28	ft/min
29	ft/h
30	m

Number	Unit
31	cm
32	°F
33	l/s
34	l/min
35	l/h
36	m <sup>3</sup> /s
37	m <sup>3</sup> /min
38	m <sup>3</sup> /h
39	kg/s
40	kg/min
41	kg/h
42	t/min
43	t/h
44	gal/s
45	gal/min
46	gal/h
47	ft <sup>3</sup> /s
48	ft <sup>3</sup> /min
49	ft <sup>3</sup> /h
50	lb/s
51	lb/min
52	lb/h
53	mbar
54	bar
55	Pa
56	kPa
57	PSI
58	mm

# Chapter 5 Troubleshooting

## 5.1 Error events

Next are the descriptions of the basic errors that may occur. For more information, refer to the user's guide.

■ Trip event screen

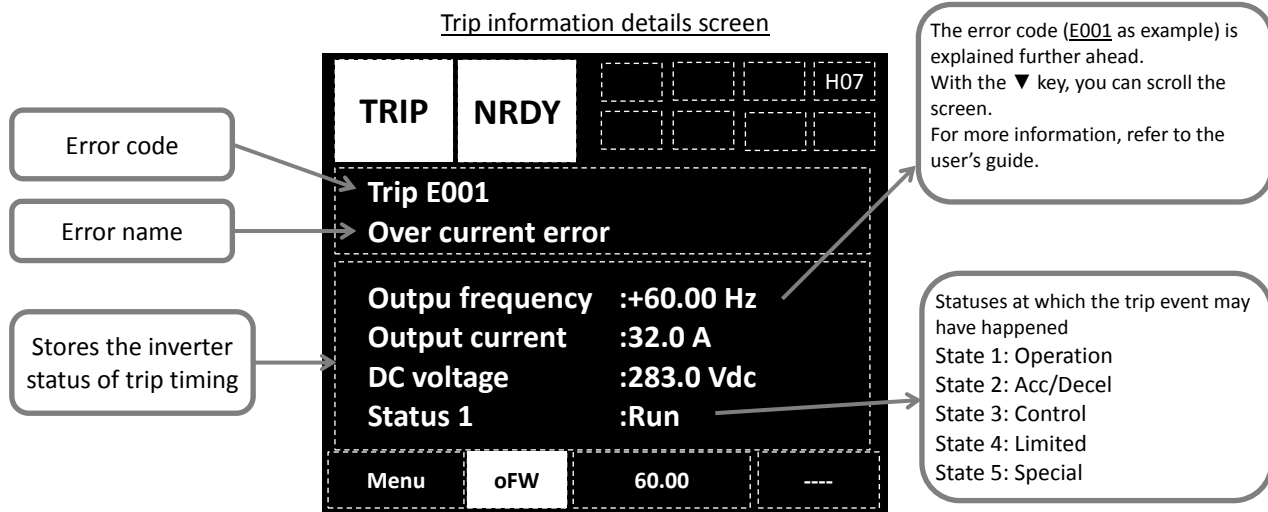

■ Error events

Code	Details	Corrective actions	Related parameter
E001	By the load and the operating conditions, overcurrent has occurred	If the acceleration is fast, increase the acceleration time	[AC120]
		Use the overcurrent suppression function	[bA120]
		Use the overload restriction function	[bA122]
		Use the overcurrent retry function	[bb-22]
		In order to stabilize the control, adjust the constant	[HA-01]
E005 E039	By the load and the operating conditions, current has increased.	If the acceleration is fast, increase the acceleration time	[AC120]
		Use the overload restriction function	[bA122]
		If the motor sound is abnormal, in order to stabilize the control, adjust the constant	[HA-01]
E006	Braking resistor use is limited.	If the deceleration is fast, increase the deceleration time	[AC122]
		Reselection of the braking resistor is necessary	[bA-60]
E007	Internal voltage has increased Insufficient capacity of the inverter	If the deceleration is fast, increase the deceleration time	[AC122]
		Use the overvoltage suppression functions	[bA140][bA146]
		Use the overvoltage retry function	[bb-23]
		Use a braking option	-
E008 E011	Main CPU abnormality	Carry out counter measures for the inverter noise	-
		Consecutive errors may cause a failure	-
E009	Main circuit supply has drop	To disable the undervoltage error, change setting	[bb-27]
		Use the undervoltage retry function	[bb-21]
E010	Current detector abnormality	Carry out counter measures for the inverter noise	-
		Consecutive errors may cause a failure, replacement of the components is necessary	-
E012	[EXT] input terminal is ON	Check the signal status of the input terminal	[dA-51]
		Check if there are no operations by communication or programme	-
E013	[USP] input terminal is ON if at the start-up, the RUN command was issued right at the start up	Make sure that an operation command is not introduced at the time of turning ON the inverter	[dA-51]

Code	Details	Corrective actions	Related parameter
E014	• Ground fault detected at main circuit voltage turning-on	• Check for ground fault of the motor, wiring, etc.	-
E015	• Continued state of incoming high power	• Review the power circumstances, such as the power supply capacity	[dA-40]
E016	• Instantaneous power failure, control supply has dropped	• If you wish to avoid the tripping, use the power loss retry function.	[bb-20]
E019	• Abnormality in temperature detector circuit	• Carry out counter measures for the inverter noise	-
		• Consecutive errors may cause a failure	-
E020	• Because of cooling-fan life span, internal temperature has raised	• Change of the cooling-fan is necessary	-
		• Lower the carrier frequency	[bb101]
E021	• Internal temperature has increased	• Requires a review of the installation circumstances	-
		• Lower the carrier frequency	[bb101]
E024	• Disconnection of the wiring in the supply side has occurred	• Check the fastening of the input wiring with screws	-
		• Check that the 3 phases are correctly inserted	-
E030	• Suddenly current increase	• Output wiring ground fault • Disconnection confirm	-
		• Check that the motor is not locked	-
E034	• Disconnection of the wiring in the motor side has occurred	• Check the output wiring disconnection, motor insulation failure, ...etc.	-
		• Check that the 3 phases are correctly inserted	-
E035	• Abnormal motor temperature	• Improve the motor cooling circumstances	-
		• Use the overload restriction function	[bA122]
	• Thermistor abnormality	• Check for the break-down of the thermistor	-
E036	• Brake abnormality	• Check the thermistor settings	[Cb-40]
		• Check for the break-down of the brake and for the disconnection of the wiring for the [BOK] signal	[dA-51]
E038	• During slow speed, current has increased	• Check the brake waiting time	[AF134][AF141]
		• If torque is needed during slow speed, a review of the inverter capacity is necessary	-
E040	• Panel disconnection error	• Check for the disconnection of the panel from the inverter	[UA-20]
		• Noise counter-measures are necessary	-
E041	• RS485 communication error	• Noise counter-measures are necessary	-
		• Check the communication setting	[CF-01]
E042	• RTC error	• Battery replacement for the panel is necessary	-
E043 ~ E045 E050 ~ E059	• There is an error in the EzSQ programme.	• For more information, please refer to the user's guide.	
E060 ~ E089	• There is an error in the option.	• For more information, please refer to each option in user's guide.	
E090 ~ E093	• There is an error in the STO path.	• For more information, please refer to the P1 functional safety guide.	

※For others errors not shown above, refer to the user's guide.

■ Warning events

※Regarding the warnings, please refer to the user's guide.  
Fixing the parameter details shown in the panel screen may end the warning

## 5.2 Confirming the status

■ Frequently asked questions – FAQ (simplified edition)

Details of display



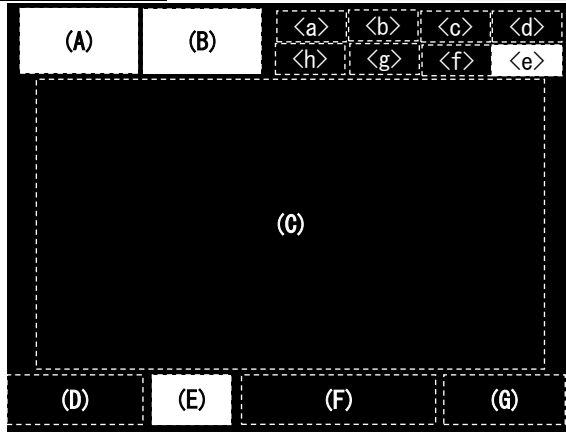

**(A) Main operation status**

Display	Description
RUN FW	While in forward operation.
RUN RV	While in reverse operation.
RUN 0Hz	While output operation is 0Hz. Even for DB, FOC and SON functions.
TRIP	Displays the trip status.
WARN	When a conflict in the setting happens.
STOP (red)	This sign is indicated when run-command is given to the is forced to stop due to the other functions. <ul style="list-style-type: none"> <li>• In an operation that is not controlled from the panel, but is stopped with the panel.</li> <li>• In a non-stop operation.</li> <li>• An operation is stopped with a terminal function.</li> </ul>
STOP (white)	While stopped, in absence of RUN command or if frequency reference is 0Hz.

(Tips)

- If STOP(in red),  
⇒Displayed in (F): if the reference frequency it is 0.00Hz, make sure that the frequency reference has been inputted.
- ⇒For example; if it is being driven by the [FW] terminal, and then stopped with the stop key, inverter will not start again the operation unless the [FW] terminal turns off and on again (re-arm).
- ⇒When [RS, [FRS] or STO terminals are in ON state it won't operate.

**(B) Warning status**

No.	Display	Description
1	LIM	While: <ul style="list-style-type: none"> <li>• Overload restriction.</li> <li>• Torque limiting.</li> <li>• Overcurrent suppression.</li> <li>• Overvoltage suppression.</li> </ul>
2	ALT	If displays the following functions: <ul style="list-style-type: none"> <li>• Overload warning.</li> <li>• Motor thermal warning.</li> <li>• Inverter thermal warning.</li> <li>• Motor heat warning.</li> </ul>
3	RETRY	While waiting for retry or restart functions.
4	NRDY	While inverter is in a state unfit to operate, even if a RUN command is issued. <ul style="list-style-type: none"> <li>• Main power undervoltage.</li> <li>• Operating only with 24V supply.</li> <li>• Resetting.</li> <li>• [REN] terminal is enabled and OFF.</li> </ul>
5	FAN	Cooling-fan life warning is issued.
6	C	Capacitor life warning is issued.
7	F/C	When both Capacitor and Cooling-fan life warnings are issued.
8	(None)	Different statuses from those shown above.

(Tips)

- LIM and ALT are indicated when current and internal voltage has risen. Review things such as the load if this error happens too often.
- Above icons are indicated when cooling-fan and smoothing capacitor lifespan has reached to the end.

**(E) Panel's RUN key function**

No.	Display	Description
1	oFW	Forward operation from panel's RUN key.
2	oRV	Reverse operation from panel's RUN key.
3	>FW	Forced forward operation.
4	>RV	Forced reverse operation.
5	(None)	Different operation (other than RUN).

(Tips)

- Displayed if the panel RUN key is activated.
- Review AA111 if is not displayed and want to use the panel for RUN operation.

Details of display (continue)

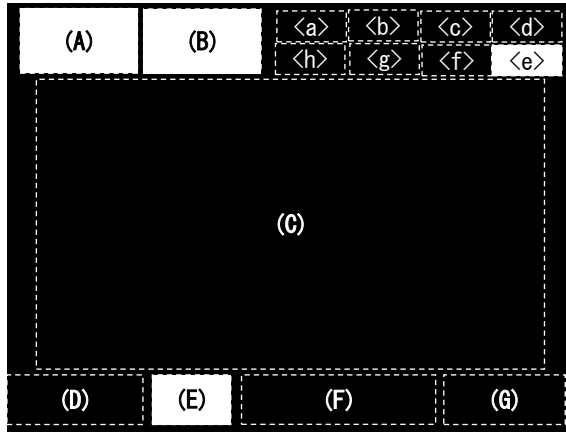

<a> Power supply status

Number	Display	Description
1	(None)	Main and control power is supplied.
2	CTRL	Control supply is connected.
3	24V	Only P+/P- 24V supply is connected.

(Tips)

- Displays the status of the supply. If CTRL or 24V is displayed means that is in a state where there is not a main power source plugged and cannot operate. Check the supply.

<b> SET function status

Number	Display	Description
1	M1	When [SET] terminal is not assigned or is assigned but in OFF state (1st-motor is enabled).
2	M2	[SET] terminal is assigned and in ON state (2nd-motor is enabled).

- When the [SET] terminal is not being used, M1 is displayed. If the centre character of the parameter is “-”([AC-01]) or “1”([AA111]) it becomes enabled, if it is “2” (such as [AA211]), it will be ignored.

<c> Parameter display

Number	Display	Description
1	(None)	Display all modes.
2	UTL	Individual function display mode.
3	USR	User’s settings display mode.
4	CMP	Data comparator display mode.
5	MON	Only monitor display mode.

(Tips)

- Is displayed if it operating under a display limiting function. Change the setting of [UA-10] in the case that the parameters are not being displayed.

<d> Monitor screen number

(Tips)

- Each screen displayed has a number. When contacting to us, make reference to the screens with its number.

(e) Functional safety

(Tips)

- If there is a display, will be shut off.

※For Functional safety display, refers to safety instruction.

<f> Control mode

Number	Display	Description
1	(None)	Speed control mode.
2	TRQ	Torque control mode.
3	POS	Position control mode.

(Tips)

- Displays the operation control mode.

<g> EzSQ mode

Number	Display	Description
1	(None)	EzSQ not selected.
2	Ez_S	EzSQ programme not running.
3	Ez_R	EzSQ programme running.

(Tips)

- Can check if EzSQ function is active.

<h> Special functions

(Tips)

- In the case it is displayed, means that the inverter entered in a special state. For more information, refer to the user’s guide.

### 5.3 Possible errors and solutions

- ✧ If the corrective action does not solve the problem, refer to the user's guide, where there are more detailed descriptions, also please consult us about inquiries through the contact data of the back cover.

Event ▶	Estimated cause ▶	Corrective action
Screen is off even when POWER Led is illuminated	▪ Keypad in idle mode	▪ Press a key of the Keypad and the screen will light up
	▪ Keypad has been detached	▪ Recover and reinsert the keypad
After issuing a RUN command, the motor does not start	▪ Trip has occurred	▪ If an error causes a trip, the cause of the trip will have to be removed before resetting
	▪ A warning came up	▪ In a warning event is necessary to resolve any data inconsistency
	▪ Command function not introduced	▪ Check that the RUN command [AA111] and the reference (terminal, keypad, etc.) are correct
	▪ Speed source not introduced	▪ Check that the main speed source [AA101] and the reference (terminal, panel, etc.) are correct
	▪ Activate a stop function	▪ Check if functional safety terminals and [RS]/[FRS] terminals are not enabled through the terminal status [dA-51]
	▪ Motor is restricted/locked	▪ Check if there is a braking operation or something inhibiting the motor (Like something clogged)
	▪ Wiring is disconnected	▪ Check that there are not disconnected cables in the output to the motor and in the internal side.
Cannot change settings	▪ Is running	▪ There are parameters that cannot be modified while running, please refer to the parameter list
Motor rotates in reverse	▪ Wrong wiring order of the motor phases	▪ Rotation is reversed by replacing two phases of the motor
Motor/machinery sound is loud	▪ Carrier frequency setting is low	▪ Set higher carrier frequency [bb101], however, that may increase the generated noise or leakage current, therefore, depending on the model, derating is necessary.

Event ▶	Estimated cause ▶	Corrective action
<p>Motor speed does not increase</p>	<ul style="list-style-type: none"> <li>Overload restriction function is in use</li> </ul>	<ul style="list-style-type: none"> <li>If output current is high, the overload restriction function [bA122] lowers the frequency. To increase the acceleration time [AC120], it is necessary to suppress the current increase.</li> </ul>
	<ul style="list-style-type: none"> <li>Frequency is being limited</li> </ul>	<ul style="list-style-type: none"> <li>The upper limit [bA102] setting may be low, and it should be increased. The frequency limiting does not make use of the maximum frequency, but the upper limit function.</li> </ul>
	<ul style="list-style-type: none"> <li>Frequency source is low</li> </ul>	<ul style="list-style-type: none"> <li>Increase the frequency source or cancel any other high priority frequency command such as jogging or multi-speed.</li> </ul>
	<ul style="list-style-type: none"> <li>Acceleration time is long</li> </ul>	<ul style="list-style-type: none"> <li>Acceleration time [AC120] setting is long, so will accelerate really slowly. Shorten gradually the acceleration time.</li> </ul>
<p>Output frequency is unstable</p>	<ul style="list-style-type: none"> <li>Several parameters are not adequately set</li> </ul>	<ul style="list-style-type: none"> <li>Check for the motor basic parameters.</li> </ul>
	<ul style="list-style-type: none"> <li>Big variation in the load</li> </ul>	<ul style="list-style-type: none"> <li>Review the power capacity of both the inverter and motor.</li> </ul>
	<ul style="list-style-type: none"> <li>Supply voltage fluctuates</li> </ul>	<ul style="list-style-type: none"> <li>To keep to a minimum the supply fluctuations, by using an optional AC reactor, DC choke or and input filter, improvement is possible.</li> </ul>
<p>No torque</p>	<ul style="list-style-type: none"> <li>V/f control is in use</li> </ul>	<ul style="list-style-type: none"> <li>Can switch in [AA121] to torque boost, sensorless vector control, ... etc.</li> </ul>
	<ul style="list-style-type: none"> <li>It is being used for lift down application</li> </ul>	<ul style="list-style-type: none"> <li>If the torque in the regenerative operation is not enough, you can use a braking resistor or regenerative braking unit.</li> </ul>
	<ul style="list-style-type: none"> <li>Very heavy load</li> </ul>	<ul style="list-style-type: none"> <li>Review the capacity of both the inverter and motor.</li> </ul>
<p>In operation the circuit breaker gets activated</p>	<ul style="list-style-type: none"> <li>Large leakage current</li> </ul>	<ul style="list-style-type: none"> <li>Lower the carrier frequency [bb101]</li> <li>Increase the current sensitivity of the circuit breaker, or replace the sensitivity current sensor/part.</li> </ul>
<p>Noise interferes with the TVs and radios nearby the inverter</p>	<ul style="list-style-type: none"> <li>Irradiated noise from the inverter</li> </ul>	<ul style="list-style-type: none"> <li>If possible, separate the wiring from the TV and radio</li> <li>Put a zero-phase reactor either in the main supply input or in the output</li> </ul>

## Chapter 6

## Inspection and maintenance



Read this before performing any inspection or maintenance!

**There is risk of electric shock!**

- Before an inspection the supply power must be cut off, and then wait at least 10 minutes or more before proceeding.  
(Make sure that the charge lamp in the inverter is off. Furthermore, measure the voltage between the P and N terminals and make sure that the voltage it is less than 45V)

- Other than the designated person, do not perform any maintenance, inspection or component replacement.  
(Before starting to operate, remove any wristwatch or metal accessories such as bracelets, and use always isolated tools)

## 6.1 Inspection and maintenance notes

### 6.1.1 Daily inspection

Check and confirm for the following abnormalities while the inverter is operating:

No.	Details	✓
1	Motor operates as per settings	<input type="checkbox"/>
2	No abnormalities in the environment	<input type="checkbox"/>
3	Cooling-system running normally	<input type="checkbox"/>
4	Abnormal vibration or noise	<input type="checkbox"/>
5	Discolouration and superheating	<input type="checkbox"/>
6	Unusual odour	<input type="checkbox"/>

While operating, check the inverter input voltage using a multimeter or a similar tool to confirm:

No.	Details	✓
1	Voltage supply fluctuation	<input type="checkbox"/>
2	Line-to-line voltage balance	<input type="checkbox"/>

### 6.1.2 Regarding the functional safety

The contents related to the functional safety are listed in the attachment [Functional safety guide].

### 6.1.3 Cleaning

Keep the inverter in a clean condition.

No.	Details	✓
1	When cleaning the inverter, use a soft cloth soaked in neutral detergent to gently wipe up the dirtied parts.	<input type="checkbox"/>
2	Do not use solvents like acetone, benzene, toluene or alcohol to clean the inverter, as it can melt its surface or peel off the coating.	<input type="checkbox"/>
3	For the display of the panel do not use detergent or alcohol to clean it.	<input type="checkbox"/>

### 6.1.4 Periodic inspection

Check the parts that are only accessible while the inverter is stopped. The periodic inspection is a vital point that has to be carried out, for any periodic inspection, please contact your Hitachi distributor.

No.	Details	✓
1	Check for abnormalities in cooling system • Heat sink cleaning, etc.	<input type="checkbox"/>
2	Check the fastening and tighten • By the effects of oscillations, thermal expansion, etc..., the screws and bolts may become loose, proceed to tighten after confirming.	<input type="checkbox"/>
3	Check that there is no damage or corrosion to the conductors and insulators	<input type="checkbox"/>
4	Measurement of the dielectric breakdown voltage of insulators	<input type="checkbox"/>
5	Check and replacement of cooling-fan, smoothing capacitor and relay.	<input type="checkbox"/>

## 6.2 Daily and periodic inspections

Inspected part	Inspection entry	Details of inspection	Inspection cycle		Inspection method	Criterion	Tester device
			Daily	Every 1 year 2 years			
General	Surrounding environment	Check the ambient temperature, level of humidity, dust, ... etc.	○		Refer to the installation guide.	Ambient temperature, level of humidity are within the range. No frozen part. No condensation.	Thermometer Hygrometer Data logger
	Whole inverter	Check abnormal vibrations or noises	○		Check visually and auditorily.	Without abnormalities	
	Power supply voltage	Check that the main circuit voltage is normal.	○		Measure the line-to-line voltage of the inverter main circuit terminals R,S and T.	Within the AC voltage permissible variation.	Multimeter, Digital multimeter Meter
Main circuit	General check	(1)Check the resistance between the main circuit and the ground terminals.		○	Dismantle the inverter main circuit terminals input/output wiring and the control terminal board, and remove the jumper for the internal filter, after that, shortcircuit the terminals R,S,T,U,V,W,P,PD,N,RB,RO,TO, and measure between this shortcircuit and the ground.	Resistance no less than 5MΩ.	DC 500V class Ohmmeter (megger®)
		(2)Check looseness in fastened parts		○	Confirm tightness of fasteners.	Without abnormalities	
		(3)Check for overheating traces.		○	Check visually.	Without abnormalities	
	Conductor and cables	(1)Check for straining in conductors (2)Check for cable coating damage		○	Check visually.	Without abnormalities	
	Terminal block	Check for any damage.		○	Check visually.	Without abnormalities	
	Inverter and converter circuits (Including resistors)	Check the resistance between all the terminals		○	Remove the inverter main circuit terminal wiring, and measure the following: - Resistance between terminals RST and PN. - Resistance between terminals UVW and PN	Consult the "Method of checking the inverter and converter circuits". The inverter, capacitor and thyristor lifespan before replacing the components is of 10 <sup>6</sup> start/stop cycles *3)	Analogue multimeter
	Smoothing capacitor	(1)Check for capacitor fluid leakage (2)Check that the relief valve does not swells or protrudes.	○		Check visually.	That there are no abnormalities Estimated number life span before exchanging component: 10 years *1) *3) *4)	Capacitance meter
Relay	(1)No chatter sound while operating (2)Check contacts for damage		○	Check auditorily. Check visually.	That there are no abnormalities. That there are no abnormalities.		
Control and protection circuits	Operation check	(1) While performing a unit operation of the inverter, check the balance of the output voltage among the individual phases		○	Measure the voltage between the U,V,W terminals of the inverter main circuit.	Phase-to-phase voltage balance 200V class: within 4V 400V class: within 8V	Digital multimeter Voltmeter Ammeter
		(2)Carry out a sequential protection test, and check the protective and display circuits for any abnormality		○	Simulate a shortcircuit or open of the inverter output protection circuit.	An error must be detected according to the sequence.	
Cooling system	Cooling-fan	(1) Check for abnormal vibrations or noises (2)Check for loose joints	○		Turn by hand while electricity is not being supplied Check visually.	Smooth operation without abnormalities. Replace every: 10 years *2) *3) *5)	
	Heat sink	Check for obstructions/clogging.		○	Check visually.	That there are not obstructions.	
Display	Display	(1)Check that LED lamps lights up (2)Display cleaning	○		Check visually. With cleaning rag.	Confirm it lights up	
	Meter	Check that Indicated values are normal.	○		Check the meter readings on the panel.	Regulation and control value are satisfactory.	Voltmeter Ammeter Etc.
Motor	General	(1)Check abnormal vibrations or noises	○		Check visually, auditorily, and by touch	Without abnormalities	
		(2)Check that there is no stench.	○		Check for abnormal superheating, damages and so on.	Without abnormalities	
	Insulation resistance	Check the resistance between the main circuit and the ground terminals.		*6)	Detach the U,V,W terminals from the inverter main circuit, and shortcircuit the motor wiring, measure with the Megger® between the motor wiring and ground terminal.	No less than 5MΩ.	DC 500V class Ohmmeter (megger®)

\*1) The life span of the smoothing capacitor is influenced by the ambient temperature. Refer to [Smoothing capacitor life span curve] for replacing measures.

\*2) The life span of the cooling-fan is influenced by the ambient temperature, the dirt and the change in its environmental conditions. Check these circumstances on the usual inspection.

\*3) The estimated time before replacement (Number of years/cycle) and the [Smoothing capacitor life span curve] are based on the design lifespan, not guaranteed.

\*4) In the case that the capacitors are replaced after that the storage period of 3 years has expired, before the first use please refer to the aging process under the following conditions before using them:

- First, apply for 1 hour the 80% of the capacitor rated voltage at ambient temperature
- Then, raise the voltage to 90%, and keep it for 1 more hour.
- Finally, apply for 5 hours the rated voltage at ambient temperature

\*5) In the case that the cooling-fan is affected by dust, obstructing it; remove the dust, after that may take 5 to 10 seconds to start again.

\*6) Follow the installed motor instructions

### 6.3 Insulation resistance test

- When performing an insulation resistance test, remove all cables to external circuits and the components connected to the terminals, to prevent it to be exposed to the test voltage.
- In the control circuit carry out a conduction test, use a multimeter (with high resistance range), do not use a megger® or buzzer /continuity tester.
- The insulation resistance test of the inverter itself is carried out only at the main circuit, do not perform an insulation resistance test in the control circuit.
- Is recommended the use of a DC500V megger® for the insulation resistance test.
- To perform an insulation resistance test of the inverter main circuit, start by removing the inverter internal filter short-circuit jumper, after that, R, S, T, U, V, W, P, PD, N, RB, RO, TO terminals are short-circuited with an electric cable as shown in the sketch below.
- After the insulation resistance test, remove the cable connected to R, S, T, U, V, W, P, PD, N, RB, RO, TO, and leave the jumper of the filter as it was before.
- Furthermore, depending on the model, the RB terminal may not be present. Please confirm in "Chapter 7 – Specification".

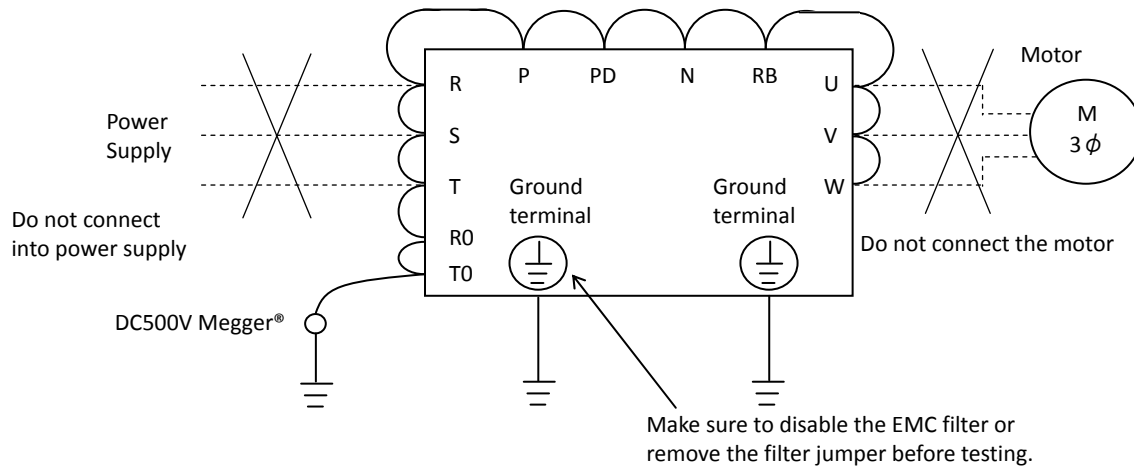

### 6.4 Dielectric Withstand Test

- Do not carry out a withstand voltage test for the inverter. The test may damage its internal parts, deteriorating the inverter.

### 6.5 Checking method for inverter/converter

• Using the multimeter, you can check if the inverter or converter unit are defective or non-defective.

(Preparation)

- ① Remove the supply (R,S,T) and motor wiring (U,V,W), and also the regenerative braking resistor(P,RB).
- ② Prepare the multimeter. (Application measurement range is 1Ω)

(Checking method)

• Measure and check the current conduction at each of the inverter main circuit terminals R, S, T, U, V, W, RB, P, N, by changing the polarity of the multimeter alternately.

		Multimeter polarity		Measured result
		⊕ (Red)	⊖ (Black)	
Converter circuit	D1	R	PD	No conduction
		PD	R	Conduction
	D2	S	PD	No conduction
		PD	S	Conduction
	D3	T	PD	No conduction
		PD	T	Conduction
Inverter circuit	D4	R	N	Conduction
		N	R	No conduction
	D5	S	N	Conduction
		N	S	No conduction
	D6	T	N	Conduction
		N	T	No conduction
BRD part	TR1	U	P	No conduction
		P	U	Conduction
	TR2	V	P	No conduction
		P	V	Conduction
	TR3	W	P	No conduction
		P	W	Conduction
TR4	U	N	Conduction	
	N	U	No conduction	
TR5	V	N	Conduction	
	N	V	No conduction	
TR6	W	N	Conduction	
	N	W	No conduction	
TR7	RB	P	No conduction	
	P	RB	Conduction	
	RB	N	No conduction	
		N	RB	No conduction

\*1) Before checking the circuits, measure the voltage across terminals P and N with the multimeter in DC voltage range mode to confirm that the smoothing capacitor has been fully discharged.

\*2) When not conducting, it shows an infinite value. Due to the influence of the smoothing capacitor, it may show momentarily any other value other than infinite. When conducting, indicates a value around several tens of ohms Ω. The measurements with different multimeters may not match exactly, but as long the values are close between them, it is acceptable.

\*3) The chopper braking circuit is built-in in the models below:  
 P1-00044L~P1-01240L(ND004L~ND220L)  
 P1-00041H~P1-00620H(ND007H~ND220H)

**Model(P1-\*\*\*\*.\*)**  
 200V class : 00044-L(004L)~00600-L(110L)  
 400V class : 00041-H(007H)~00310-H(110H)

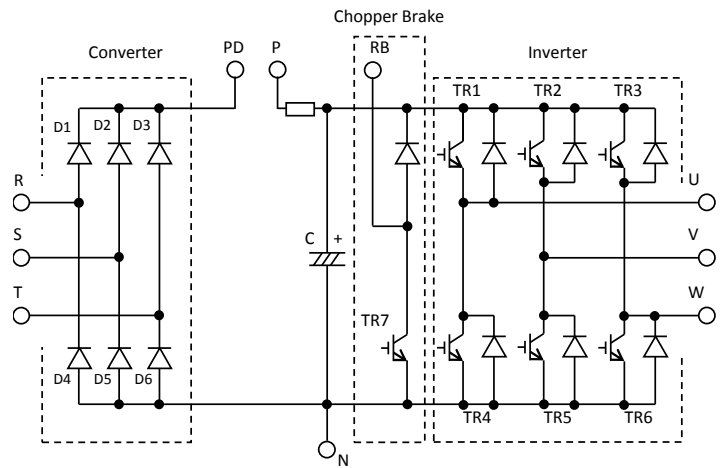

**Model(P1-\*\*\*\*.\*)**  
 200V class : 00800-L(150L)~04300-L(900L)  
 400V class : 00400-H(150H)~03160-H(1320H)

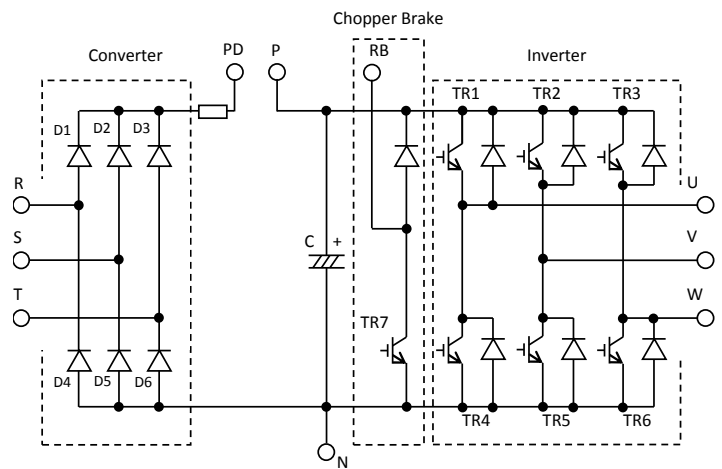



## 6.6 Smoothing capacitor life span curve

※80% of the ND rated current value for continuous drive.

※80% of the ND rated current value for continuous drive.

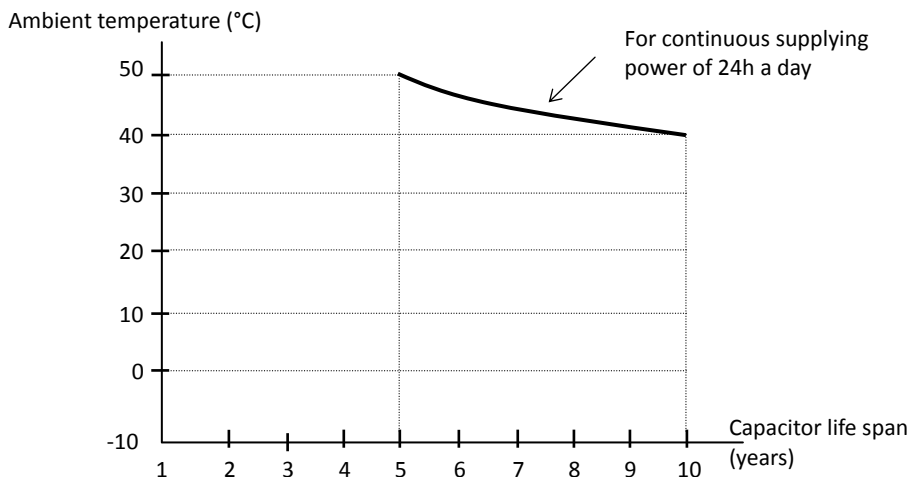

\*1) The ambient temperature is considered to be measured around 5 cm of the bottom centre of the inverter (Atmosphere temperature). If the inverter is in an enclosure, it will be the temperature inside the case.

\*2) The smoothing capacitor has a limited life because of the chemical reactions occurring inside the capacitor while operating. The capacitor should be replaced after 10 years of use, as a reference standard (10 years is not the guaranteed lifespan, but rather, the design lifespan). Note that the smoothing capacitor lifespan will be shortened if the inverter is used at a high ambient temperature or with a heavy load that requires a current beyond the rated current.

## 6.7 Lifespan alarm output

- Thanks to the self-diagnostic, you can output an alarm in regards of the inverter own internal components lifespan when the lifespan is nearing to its end (Including the circuit board smoothing capacitor and cooling-fan, and excluding the main circuit smoothing capacitor). Use this to get a reference for when the components should be replaced. Particularly, consult the lifespan diagnosis monitor [dC-16] and the output terminal function selection [CC-01]~[CC-07]. It should be noted that the warning itself is based on the design lifespan, and thus, is not a guaranteed measurement. Depending on the environment, the operation conditions, etc. problems may arise, to avoid that, is recommended an early maintenance.

### 6.8 Input/output voltage, current and power measurement methods

Standard equipment for measuring input/output voltage, current, and power measurement.

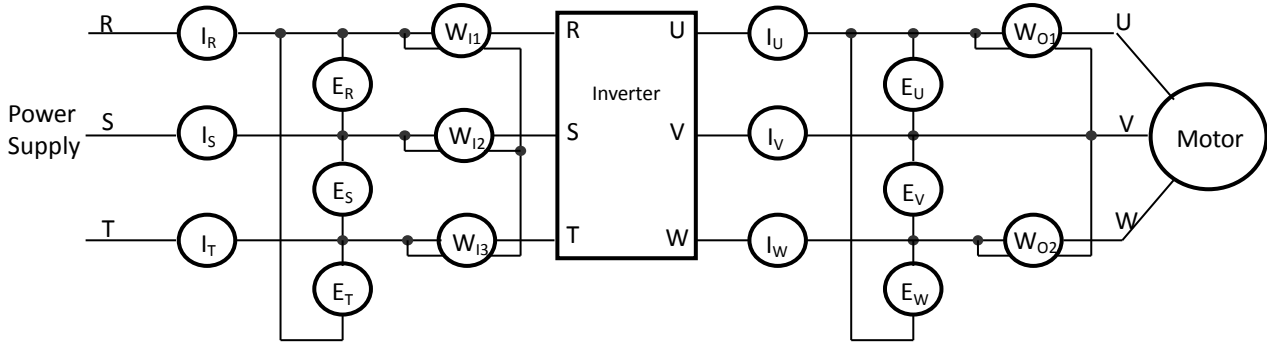

Measured data	Measuring point	Measuring instrument	Remarks	Standard reference values
Input voltage $E_{IN}$	R-S, S-T, T-R ( $E_R$ ), ( $E_S$ ), ( $E_T$ )	Moving-iron voltmeter or Rectifier-type voltmeter	Effective value of full waves	200V class:200~240V 50/60Hz 400V class:380~500V 50/60Hz
Input current $I_{IN}$	R, S, T current ( $I_R$ ), ( $I_S$ ), ( $I_T$ )	Moving-iron ammeter	Effective value of full waves	If there is unbalance in the input supply $I_{IN}=(I_R+I_S+ I_T)/3$
Input power $W_{IN}$	R-S, S-T, T-R ( $W_{11}$ )+( $W_{12}$ )+( $W_{13}$ )	Electrodynamic-type wattmeter	Effective value of full waves	Three-wattmeter method
Input power factor $Pf_{IN}$	Is calculated from the measured values of the input voltage ( $E_{IN}$ ), input current ( $I_{IN}$ ) and supply power ( $W_{IN}$ ) $Pf_{IN} = \frac{W_{IN}}{\sqrt{3} \times F_{IN} \times I_{IN}} \times 100$			
Output voltage $E_{OUT}$	U-V, V-W, W-U ( $E_U$ ), ( $E_V$ ), ( $E_W$ )	Moving-iron voltmeter or Rectifier-type voltmeter	Effective value of fundamental wave	
Output current $I_{OUT}$	U, V, W current ( $I_U$ ), ( $I_V$ ), ( $I_W$ )	Moving-iron ammeter	Effective value of full waves	
Output power $W_{OUT}$	U-V, V-W ( $W_{01}$ )+( $W_{02}$ )	Electrodynamic-type wattmeter	Effective value of full waves	Two-wattmeter method (Otherwise the three-wattmeter method)
Output power factor $Pf_{OUT}$	Is calculated from the measured values of the output voltage ( $E_{OUT}$ ), output current ( $I_{OUT}$ ) and output power ( $W_{OUT}$ ). $Pf_{OUT} = \frac{W_{OUT}}{\sqrt{3} \times F_{OUT} \times I_{OUT}} \times 100$			

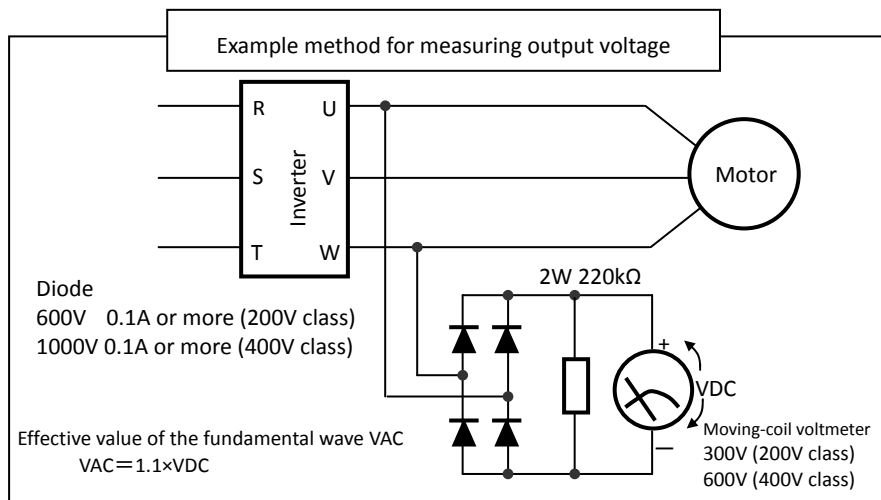

When measuring...

1. To measure the output voltage, use an instrument that reads the effective value of the fundamental wave. To measure the current or the power, use an instrument that reads the effective value of full waves.
2. Since the inverter output waveform is controlled by PWM, it has a large margin of error, especially at low frequencies. In many cases, general testers may be defective for the measurement, because of the adverse effects of the noise.

# Chapter 7

## Specifications

### 7.1 200V class specifications

Model name(format) P1-*****-L		00044	00080	00104	00156	00228	00330	00460	00600	00800	00930	01240	01530	01850	02290	02950		
ND standard capacity P1-***L		004	007	015	022	037	055	075	110	150	185	220	300	370	450	550		
Applicable motor capacity (4 poles)(kW)	VLD	0.75	1.5	2.2	3.7	5.5	7.5	11	15	18.5	22	30	37	45	55	75		
	LD	0.75	1.5	2.2	3.7	5.5	7.5	11	15	18.5	22	30	37	45	55	75		
	ND	0.4	0.75	1.5	2.2	3.7	5.5	7.5	11	15	18.5	22	30	37	45	55		
Output	Rated output current(A)	VLD	4.4	8.0	10.4	15.6	22.8	33.0	46.0	60.0	80.0	93.0	124	153	185	229	295	
		LD	3.7	6.3	9.4	12.0	19.6	30.0	40.0	56.0	73.0	85.0	113	140	169	210	270	
		ND	3.2	5.0	8.0	11.0	17.5	25.0	32.0	46.0	64.0	76.0	95.0	122	146	182	220	
	Overload current rating	VLD	110% 60sec / 120% 3sec															
		LD	120% 60sec / 150% 3sec															
		ND	150% 60sec / 200% 3sec															
	Rated output voltage		Three-phase(3 wire)200~240V (Corresponding to the incoming voltage)															
	Rated capacity (kVA)	200V	VLD	1.5	2.8	3.6	5.4	7.9	11.4	15.9	20.8	27.7	32.2	43.0	53.0	64.1	79.3	102.2
			LD	1.3	2.2	3.3	4.2	6.8	10.4	13.9	19.4	25.3	29.4	39.1	48.5	58.5	72.7	93.5
ND			1.1	1.7	2.8	3.8	6.1	8.7	11.1	15.9	22.2	26.3	32.9	42.3	50.6	63.0	76.2	
240V		VLD	1.8	3.3	4.3	6.5	9.5	13.7	19.1	24.9	33.3	38.7	51.5	63.6	76.9	95.2	122.6	
		LD	1.5	2.6	3.9	5.0	8.1	12.5	16.6	23.3	30.3	35.3	47.0	58.2	70.3	87.3	112.2	
		ND	1.3	2.1	3.3	4.6	7.3	10.4	13.3	19.1	26.6	31.6	39.5	50.7	60.7	75.7	91.5	
Input	Rated input current(A) *1)	VLD	5.2	9.5	12.4	18.6	27.1	39.3	54.8	71.4	95.2	110.7	147.6	182.1	220.2	272.6	351.2	
		LD	4.4	7.5	11.2	14.3	23.3	35.7	47.6	66.7	86.9	101.2	134.5	166.7	201.2	250.0	321.4	
		ND	3.8	6.0	9.5	13.1	20.8	29.8	38.1	54.8	76.2	90.5	113.1	145.2	173.8	216.7	261.9	
	Rated input AC voltage *2)		Control power: Single-phase supply 200~240V / allowable bands of fluctuations 170-264V, 50Hz(47.5-52.5Hz)/60Hz(57-63Hz) Main circuit power supply: Three-phase(3 wire) 200~240V / allowable bands of fluctuations 170-264V, 50Hz(47.5-52.5Hz)/60Hz(57-63Hz)															
	Power supply capacity (kVA) *3)	VLD	2.0	3.6	4.7	7.1	10.3	15.0	20.9	27.2	36.3	42.2	56.3	69.4	83.9	103.9	133.8	
		LD	1.7	2.9	4.3	5.4	8.9	13.6	18.1	25.4	33.1	38.6	51.3	63.5	76.7	95.3	122.5	
ND		1.5	2.3	3.6	5.0	7.9	11.3	14.5	20.9	29.0	34.5	43.1	55.3	66.2	82.6	99.8		
Carrier frequency variation *4)		VLD	0.5~10.0kHz															
		LD	0.5~12.0kHz															
		ND	0.5~16.0kHz															
Starting torque *5)		200%/0.3Hz																
Braking	Regenerative	Internal BRD circuit (external discharge resistor value)												External regenerative braking unit				
	Minimum resistance value(Ω)	50	50	35	35	35	16	10	10	7.5	7.5	5	-	-	-	-		
Dimensions *6)	H(height)(mm)	255	255	255	255	255	260	260	260	390	390	390	540	550	550	700		
	W(width)(mm)	150	150	150	150	150	210	210	210	245	245	245	300	390	390	480		
	D(Depth)(mm)	140	140	140	140	140	170	170	170	190	190	190	195	250	250	250		
Protective structure		IP20 – UL Open Type																
Aprox. weight (kg)		4	4	4	4	4	7	7	7	16	16	16	22	30	30	43		

\*1) The rated input current is the value when the drive is operated in the rated output current. The value of the impedance at the supply side changes due to the wiring, breaker, input reactor, etc.

\*2) Following are for Low Voltage Directive (LVD) compliant.  
- Pollution degree 2  
- Overvoltage category 3

\*3) The power supply capacity is the value of the rated output current at 220V. Impedance at the supply side changes due to the wiring, breaker, input reactor, etc.

\*4) Is necessary to set the carrier frequency settings [bb101]/[bb201] equal or greater than the (maximum output frequency x 10)Hz. For induction motor IM, set the carrier frequency to 2 kHz or more except V/f control. For synchronous motor (SM), permanent magnet motor (PMM) set the carrier frequency to 8 kHz or more.

\*5) The values for the sensorless vector control are assigned according to the values in the ND rating of the Hitachi standard motor table. Torque characteristics may vary by the control system and the use of the motor.

\*6) The key height of keypad are excluded from dimensions. When an option is connected, the dept necessary is increased. Refer to the each optional instruction.

## 7.2 400V class specifications

Model name(format) P1-*****-L		00041	00054	00083	00126	00175	00250	00310	00400	00470	00620	00770	00930	01160	01470	01760	02130	02520	03160		
ND standard capacity P1-***L		007	015	022	037	055	075	110	150	185	220	300	370	450	550	750	900	1100	1320		
Applicable motor capacity (4 poles)(kW)	VLD	1.5	2.2	3.7	5.5	7.5	11	15	18.5	22	30	37	45	55	75	90	110	132	160		
	LD	1.5	2.2	3.7	5.5	7.5	11	15	18.5	22	30	37	45	55	75	90	110	132	160		
	ND	0.75	1.5	2.2	3.7	5.5	7.5	11	15	18.5	22	30	37	45	55	75	90	110	132		
Output	Rated output current(A)	VLD	4.1	5.4	8.3	12.6	17.5	25.0	31.0	40.0	47.0	62.0	77.0	93.0	116	147	176	213	252	316	
		LD	3.1	4.8	6.7	11.1	16.0	22.0	29.0	37.0	43.0	57.0	70.0	85.0	105	135	160	195	230	290	
		ND	2.5	4.0	5.5	9.2	14.8	19.0	25.0	32.0	39.0	48.0	61.0	75.0	91.0	112	150	180	217	260	
	Overload current rating	VLD	110% 60sec / 120% 3sec																		
		LD	120% 60sec / 150% 3sec																		
		ND	150% 60sec / 200% 3sec																		
	Rated output voltage		Three-phase(3 wire)380~500V (Corresponding to the incoming voltage)																		
	Rated capac ity (kVA)	400V	VLD	2.8	3.7	5.8	8.7	12.1	17.3	21.5	27.7	32.6	43.0	53.3	64.4	80.4	101.8	121.9	147.6	174.6	218.9
			LD	2.1	3.3	4.6	7.7	11.1	15.2	20.1	25.6	29.8	39.5	48.5	58.9	72.7	93.5	110.9	135.1	159.3	200.9
			ND	1.7	2.8	3.8	6.4	10.3	13.2	17.3	22.2	27.0	33.3	42.3	52.0	63.0	77.6	103.9	124.7	150.3	180.1
500V		VLD	3.6	4.7	7.2	10.9	15.2	21.7	26.8	34.6	40.7	53.7	66.7	80.5	100.5	127.3	152.4	184.5	218.2	273.7	
		LD	2.7	4.2	5.8	9.6	13.9	19.1	25.1	32.0	37.2	49.4	60.6	73.6	90.9	116.9	138.6	168.9	199.2	251.1	
		ND	2.2	3.5	4.8	8.0	12.8	16.5	21.7	27.7	33.8	41.6	52.8	65.0	78.8	97.0	129.9	155.9	187.9	225.2	
Input	Rated input current(A) *1)	VLD	4.9	6.4	9.9	15.0	20.8	29.8	36.9	47.6	56.0	73.8	91.7	110.7	138.1	175.0	209.5	253.6	300.0	376.2	
		LD	3.7	5.7	8.0	13.2	19.0	26.2	34.5	44.0	51.2	67.9	83.3	101.2	125.0	160.7	190.5	232.1	273.8	345.2	
		ND	3.0	4.8	6.5	11.0	17.6	22.6	29.8	38.1	46.4	57.1	72.6	89.3	108.3	133.3	178.6	214.3	258.3	309.5	
	Rated input AC voltage *2)		Control power: Single-phase supply 380-500V / Allowable bands of fluctuations 323-550V, 50Hz(47.5-52.5Hz)/60Hz(57-63Hz) Main circuit power supply: Three-phase(3 wire) 380-500V / Allowable bands of fluctuations 323-550V, 50Hz(47.5-52.5Hz)/60Hz(57-63Hz)																		
	Power supply capacity (kVA) *3)	VLD	3.7	4.9	7.5	11.4	15.9	22.7	28.1	36.3	42.6	56.3	69.9	84.4	105.2	133.4	159.7	193.2	228.6	286.7	
		LD	2.8	4.4	6.1	10.1	14.5	20.0	26.3	33.6	39.0	51.7	63.5	77.1	95.3	122.5	145.2	176.9	208.7	263.1	
ND		2.3	3.6	5.0	8.3	13.4	17.2	22.7	29.0	35.4	43.5	55.3	68.0	82.6	101.6	136.1	163.3	196.9	235.9		
Carrier frequency variation *4)	VLD	0.5~10.0kHz															0.5~8.0kHz				
	LD	0.5~12.0kHz															0.5~8.0kHz				
	ND	0.5~16.0kHz															0.5~10.0kHz				
Starting torque *5)		200%/0.3Hz															180%/0.3Hz				
Braking	Regenerative	Internal BRD circuit (external discharge resistor value)													*6)		Ext. regen. braking unit				
	Minimum resistance value(Ω)	100	100	100	70	70	35	35	24	24	20	15	15	10	10	-	-	-	-		
Dimensions*7)	H(height)(mm)	255	255	255	255	260	260	260	390	390	390	540	550	550	550	700	700	740	740		
	W(width)(mm)	150	150	150	150	210	210	210	245	245	245	300	390	390	390	390	390	480	480		
	D(Depth)(mm)	140	140	140	140	170	170	170	190	190	190	195	250	250	250	270	270	270	270		
Protective structure		IP20 – UL Open Type																			
Approx. weight (kg)		4	4	4	4	7	7	7	16	16	16	22	30	30	30	55	55	70	70		

\*1) The rated input current is the value when the drive is operated in the rated output current. The value of the impedance at the supply side changes due to the wiring, breaker, input reactor, etc.

\*2) Make sure the following for Low Voltage Directive (LVD) compliant.  
- Pollution degree 2  
- Overvoltage category 3 (for 380~460Vac Input supply)  
- Overvoltage category 2 (for over 460Vac Input supply)

\*3) The power supply capacity is the value of the rated output current at 440V. Impedance at the supply side changes due to the wiring, breaker, input reactor, etc.

\*4) Is necessary to set the carrier frequency settings [bb101]/[bb201] equal or greater than the (maximum output frequency x 10)Hz. For induction motor IM, set the carrier frequency to 2 kHz or more except V/f control. For synchronous motor (SM), permanent magnet motor (PMM) set the carrier frequency to 8 kHz or more.

\*5) The values for the sensorless vector control are assigned according to the values in the ND rating of the Hitachi standard motor table. Torque characteristics may vary by the control system and the use of the motor.

\*6) Usually is required an external regenerative braking unit. However, with an optional built-in chopper braking circuit and external discharge resistor can eliminate a external regenerative unit. The built-in chopper braking circuit is offered by order. In order to purchase, contact to the nearest sales office.

\*7) The key height of keypad are excluded from dimensions. When an option is connected, the dept necessary is increased. Refer to the each optional instruction.

## 7.3 Common specifications

\*4) If by the protective function, the IGBT error [E030] occurs, it may

PWM system	Sine-wave PWM system			
Output frequency range *1)	0.00~590.00Hz			
Frequency accuracy	For the highest frequency, digital±0.01%, analogue±0.2% (25±10°C)			
Frequency resolution	Digital: 0.01Hz Analogue: Max. frequency/4000 (Ai1 terminal/Ai2 terminal:12bit/0~+10V or 0~+20mA, Ai3 terminal 12bit/-10~+10V)			
Control system *2)	IM	V/f control (constant torque/reduced torque/free), automatic boost control Cascade type sensorless vector control, 0Hz sensorless vector control		
	SM/PMM	synchronous startup for smart sensorless vector control		
Speed fluctuation *3)	±0.5%(sensorless vector control)			
Acceleration/deceleration time	0.00~3600.00s (Linear, S-curve, U-curve, Inverted-U-curve, EL-S-curve)			
Display	Output frequency, Output current, output torque, trip history, input/output terminal story, input/output terminal function, input/output power, PN voltage, etc., are described in the contents of 4-11 chapter [Monitor's description].			
Start functions	DC braking after the start, matching frequency after the start, active frequency matching start, Low-voltage start, retry restart.			
Stop functions	After free run stop, deceleration stop; DC braking or external DC braking operation (Braking force, time, adjustment of operation speed)			
Stall prevention function	Overload limit function, overcurrent supression, overvoltage supression function			
Protection functions *4)	Overcurrent error, overload error, brake resistor overload, overvoltage error, memory error, undervoltage error, current detector error, CPU error, external trip error, USP error, ground error, supply overvoltage error, power loss error, temperature detector error, Cooling-fan rotation speed decrease, temperature error, phase input error, IGBT error, phase output error, thermistor error, brake error, low-speed range overload error, inverter overload, RS485communication error, RTC error, the rest is described in the contents of 5-1 "Input terminal function list".			
Other functions	V/f free setting (7 points), upper and lower speed limit, speed jump, curve acceleration and deceleration, manual torque boost, energy-saven operation, analogue output adjustment, minimum speed, carrier frequency adjustment, motor electronic thermal function(free is possible), inverter thermal function, external start-end(speed and rate), frequency input selection, trip retry, restart stop, various signal output, inilization setting, PID control, auto-decel at shut-off, brake control function, commercial switching function, auto-tuning (on/offline), the rest is described in the contents of 4-13 "Parameters decription".			
Input	Frequency reference	Panel	UP, DOWN keys according to the set parameter.	
		External signal *5)	Ai1/Ai2 terminal (for voltage input)	0~10Vdc set by the voltage input (Input impedance:10kΩ)
			Ai1/Ai2 terminal (for current input)	0~20mA set by the current input (Input impedance:100Ω)
			Ai3 terminal	-10~+10Vdc set by the voltage input (Input impedance:10kΩ)
			Multi-speed terminal	16multi-speed(With the use of the intelligent input terminal)
	Pulse train-input		Maximum 32kHzx2	
	Communication port	RS485 serial communication (Protocol: Modbus-RTU)		
	RUN/Stop Forward/Reverse	Keypad	By RUN/Stop key (With the set parameter, forward/reverse can be switched)	
		External signal	Forward (FW)/Reverse(RV)(When input terminal functions are allocated) 3-wire input allowed(When input terminal functions are allocated)	
		Communication Port	Set by RS485 communication (Maximum: 115.2kbps)	
	Intelligent input terminals	11 terminals (A or B terminal accept a pulse train) FW(Forward rotation)/RV(Reverse rotation), CF1~4(Multi-speed 1~4), SF1~7(Multi-speed bit 1~7), ADD(Trigger for frequency addition), SCHG(Command change), STA(3-wire start)/STP(3-wire stop)/F_R(Forward/reverse by 3-wire), AHD(Analogue command holding, FUP(Remote control up)/FDN(Remote control down), UDC(Remote data clearance), F-OP(Forcible operation), SET(2nd-motor), RS(Reset), JG(Jogging), DB(External DC braking), 2CH(2-stage acc/decel), FRS(Free-run stop), EXT(External trip), USP(Unattended start protection), CS(Commercial power supply switching), SFT(Software lock), BOK(Braking confirmation), OLR(Overload restriction selection), KHC(Accumulated input power clear), OKHC(Accumulated input), PID(PID1 disable), PIDC(PID1 integration reset), PID2(PID2 disable), PIDC2(PID2 integration reset), SVC1~4(PID1 multistage target value 1~4), PRO(PID gain change), PIO(PID output change), SLEEP(SLEEP trigger)/WAKE(WAKE trigger), TL(Enable torque limit), TRQ1/2(Torque limit 1/2), PPI(P/PI switching), CAS(Control gain switching), SON(Servo-ON), FOC(Forcing), ATR(Enable torque command input), TBS(Enable torque bias), ALP(Auto-learning positioning), LAC(LAD cancellation), PCLR(Position deviation clearance), STAT(Enable 90°-shift phase), PUP(Position bias addition), PDN(Position bias subtraction), CP1~4(Multistage position 1~4), ORL(Zero-return limit function), ORG(Zero-return trigger function) FOT(Forward drive stop), ROT(Reverse drive stop), SPD(Speed/position change), PSET(Position data pre-set), Mi1~11(General-purpose input 1~11), PCNT(Pulse counter), PCC(Pulse counter clearance), ECOM(EzCOM activation), PRG(EzSQ programme start), HLD(Acc/decel stop), REN(Motion enable signal), DISP(Display lock), PLA(Pulse train input A), PLB(Pulse train input B), DTR(Data trace start signal), etc., the rest, is described in the contents of 4-34 "Input terminal function list".		
Backup supply terminal	P+/P-: DC24V input(Input allowable voltage: 24V±10%)			
Functional safety STO input terminal	2 terminals (Simultaneous input)			
Thermistor input terminal	1 terminal (PTC/NTC resistor allowed)			

\*1) Output frequency range will depend on the motor control method and the motor used. Consult the motor manufacturer for the maximum allowable frequency of the motor when operating beyond 60Hz.

\*2) If you want to change the control mode and the motor constant is not set appropriately, the desired starting torque cannot be obtained and also exists the possibility of tripping.

\*3) Regarding the speed range regulation of motor, the variable range depends on the client system and the environment in which the motor is used. Please contact us for more information.

have happened by the short-circuit protection, but also can occur if the IGBT is damaged. Depending on the operation status of the inverter, instead of the IGBT error, the overcurrent error [Er001] may also occur.

\*5) The maximum output frequency for analogue input signal Ai1/Ai2 is adjusted to 9.8V for voltage input and 19.6mA for current input. In order to adjust the specification use analogue start/end function.

### 7.3 Common specifications (continue)

Output	Intelligent output terminals	Transistor output terminal 5, 1a contact relay 1 point, 1c contact relay 1 point	
	Relay/ Alarm relay (1a, 1c) function	RUN(While in run), FA1~5(Reached frequency signal), IRDY(Inverter ready), FWR(Forward rotation), RVR(Reverse rotation), FREF(panel frequency reference), REF(panel motion operation), SETM(2nd-motor selected), OPO(Option-Output), AL(Alarm signal), MJA(Major failure signal), OTQ(Over-torque), IP(Power loss), UV(Undervoltage), TRQ(Torque limited), IPS(Decel. Power loss), RNT(RUN time exceeded), ONT(ON time exceeded), THM(Motor electronic thermal warning), THC(Electronic thermal warning), OH1(Motor temperature increase), WAC(Capacitor life warning), WAF(Cooling-fan life warning), FR(Operation signal), OHF(heat sink overheat warning), LOC/LOC2(Low-current indication signal), OL/OL2(Overload warning signal 1/2), BRK(Brake release)/BER(Brake error)/CON(Contact control), ZS(0Hz detection signal), DSE(Maximum speed deviation), PDD(Maximum position deviation), POK(Positioning completed), PCMP(Pulse counter compare output), OD/OD2(Output deviation for PID control), FBV/FBV2(PID feedback comparison), NDC(Communication disconnection), Ai1Dc/Ai2Dc/Ai3Dc(Analogue Ai1/Ai2/Ai3 disconnection), WCAi1/WCAi2/WCAi3(Window comparator Ai1/Ai2/Ai3), LOG1~7(logical operation result 1~7), MO1~7(General-output 1~7), WFT(Trace waiting signal), TRA(Trace running signal), LBK(Low battery of panel), OVS(Not assigned), the rest, is described in the contents of 4-35 "Output terminal function list".	
	EDM output terminal	Functional safety diagnostic output	
	Output terminal monitor *6)	The data of the monitor can be selected by the parameter of the output.	
EMC filter *7)		EMC filter can be enable (The filter exchange method can alter depending on the model)	
PC external access		USB Micro-B	
Operating environment	Ambient temperature	ND	-10~50°C
		LD	-10~45°C
		VLD	-10~40°C
	Storage temperature *8)	-20~65°	
	Level of humidity	20~90%RH(No condensation allowed)	
Vibration tolerance *9)	Model: up to P1-01240L(P1-220L) up to P1-00620H(P1-220H)	5.9m/s <sup>2</sup> (0.6G), 10~55Hz	
	Model: more than P1-01530L(P1-300L) More than P1-00770H(P1-300H)	2.94m/s <sup>2</sup> (0.3G), 10~55Hz	
Installation place *10)	A maximum altitude of 1000m, without gases or dust.		
Components life span	The life span of the main circuit smoothing capacitors is 10 years.		
	The life span of the cooling-fan is 10 years.		
Conformity standars *11)	UL, cUL, CE marking, RCM		
Coating color	Black		
Optional slots	3 ports		
Optional boards	Input/output option	Analogue input/output option, relay output option	
	Communication option	Ethernet(TCP/IP)、EtherCAT、PROFIBUS DP、PROFINET	
	Feedback option	Line driver input(RS422), push-pull input, resolver input	
	Temperature detector option	Optional temperature measuring sensor	
	Functional safety option	Functional safety option	
Other optional components	Braking resistor, AC reactor, noise filter,operator cable, harmonics suppression unit, noise filter, LCRfilter, analog panel, regenerative braking unit, power regeneration converter, sine wave converter, various control application devices, PC software ProdriveNext, relay expansion terminal board, SJ300/SJ700 conection board		

\*6) The analogue voltage and analogue current monitor are estimated outputs of the analogue meter connection. Maximum output value might deviate slightly from 10V or 20mA by variation of the analogue output circuit. If you want to change the characteristics, adjust the Ao1 and Ao2 adjustment functions.

There is monitor data that cannot be part of the output.

\*7) In order to enable the EMC filter, connect to the neutral grounding supply. The leakage current may increase.

\*8) Storage temperature is the temperature during transport.

\*9) In accordance with the test methods of JIS C 60068-2-6:2010(IEC 60068-2-6:2007).

\*10) In case of utilization at an altitude of 1000m or more, take into account that the atmospheric pressure is reduced by 1% for every 100m up. Apply 1% derating from the rated current by increasing every 100m, and conduct an evaluation test. Contact us when using above 2500m ambient.

\*11) Insulation distance is in accordance with the UL and CE standards.

### 7.4 Current derating

For using with carrier frequency over 2.1 kHz, or when changing load ratings to LD/VLD, refer to P1 user's guide section "20.4 Current derating table".

- A**
- absolute position control ..... 4-18
  - accel/decel curve selection ..... 4-15
  - acceleration curve constant ..... 4-16
  - acceleration time ..... 4-16
  - acceleration (2) time ..... 4-16
  - ADD ..... 4-36
  - AHD ..... 4-36
  - Auto learning function ..... 4-18
  - Auto tuning ..... 4-46
  - automatic carrier frequency reduction ..... 4-31
  - automatic torque boost ..... 4-50
  - AVR ..... 4-30
- B**
- BOK ..... 4-36
  - braking control ..... 4-30
  - BRD ..... 4-30
  - BRK ..... 4-40
- C**
- capacitor life warning ..... 4-40
  - carrier frequency ..... 4-31
  - CF1, CF2, CF3, CF4 ..... 4-36
  - CM1 ..... 2-22
  - commercial power supply switching ..... 4-36
  - constant-torque characteristic (VC) ..... 4-14
  - control mode selection ..... 4-14
  - control circuit terminal ..... 2-19
  - control gain switching ..... 4-37
  - control mode ..... 4-14
  - cooling-fan operation ..... 4-31
  - CS ..... 4-36
  - 2CH ..... 4-36
- D**
- data comparison display ..... 4-59
  - DB ..... 4-19
  - DC braking ..... 4-19
  - DC voltage monitoring ..... 4-58
  - deceleration (2) time setting ..... 4-30
  - deceleration curve constant ..... 4-16
  - deceleration overvoltage restraint ..... 4-29
  - deceleration time ..... 4-29
  - deceleration stop at power loss ..... 4-29
  - derating ..... 7-4
  - DSE ..... 4-41
  - Dwell ..... 4-21
- E**
- easy sequence ..... 4-61
  - electronic gear ..... 4-18
  - electronic thermal ..... 4-33
  - electronic thermal warning level setting ..... 4-43
  - enable position saving ..... 4-18
  - energy saving operation ..... 4-48
  - external DC braking ..... 4-36
  - external thermistor ..... 2-21
  - external trip ..... 4-36
  - ezCOM ..... 4-45
- F**
- FA1, FA2, FA3, FA4, FA5 ..... 4-40
  - FBV ..... 4-41
  - FM ..... 2-22
  - FOC ..... 4-37
  - forcible operation ..... 4-36
  - forcing ..... 4-37
  - FOT ..... 4-37
  - free setting of electronic thermal
    - characteristic ..... 4-33
  - free V/f characteristic ..... 4-49
  - free-run stop ..... 4-14
  - frequency addition ..... 4-36
  - frequency arrival setting for accel. .... 4-43
  - frequency arrival setting for decel. .... 4-43
  - frequency limit ..... 4-28
  - frequency lower limit ..... 4-28
  - frequency matching ..... 4-32
  - frequency reference ..... 4-13
  - frequency reached signal ..... 4-40
  - frequency scaling conversion factor ..... 4-15
  - frequency to be added ..... 4-13
  - frequency upper limit ..... 4-31
  - FRS ..... 4-32
  - FW ..... 4-36
  - FWR ..... 4-40
- H**
- heat sink overheat warning ..... 4-40
  - heat sink temperature monitoring ..... 4-11
  - home search ..... 4-18
- I**
- Individual Acc/Dec for multispeed ..... 4-15
  - initialization ..... 4-60
  - input terminal response time ..... 3-36
  - input method for acc/dec time ..... 4-15
  - inspection ..... 6-1
  - intelligent input terminal ..... 2-19
  - intelligent input terminal status ..... 4-2
  - intelligent output terminal ..... 2-20
  - inverter ready signal ..... 4-40
  - IRDY ..... 4-40
  - IVMS ..... 4-51
- J**
- JG ..... 4-36
  - jogging ..... 4-36
  - jump (resonant frequency avoidance) ..... 4-21
- K**
- Keypad key settings ..... 4-14
  - KHC ..... 4-36
- L**
- LAC ..... 4-37
  - LOC ..... 4-40
  - LOG1, LOG2, LOG3, LOG4, LOG5, LOG6 ..... 4-41
  - logical output signal operation ..... 4-42
  - low-current indication signal ..... 4-43

## M

main circuit terminal.....	2-7
major failure signal .....	4-40
manual torque boost.....	4-48
MI1, MI2, MI3, MI4, MI5, MI6, MI7, MI8.....	4-37
MO1, MO2, MO3, MI4, MO5, MO6.....	4-41
MJA .....	4-40
Modbus.....	4-45
monitor mode.....	4-2
motor constant.....	4-48
motor gear ratio .....	4-32
multispeed command .....	4-15
multistage position switching .....	4-37

## N

NDc .....	4-41
NO/NC .....	4-35

## O

OHF .....	4-40
OL, OL2.....	4-40
OLR .....	4-36
online auto-tuning .....	4-46
operation after option error .....	4-31
operation frequency.....	4-13
operation mode.....	4-33
operation time over signal (RNT)/plug-in time over signal (ONT).....	4-40
overcurrent suppress .....	4-29
overload restriction .....	4-29
overvoltage suppression .....	4-29

## P

PID1.....	4-22
Position contrl.....	4-18
Pre set position.....	4-18

## R

Restart operation .....	4-14
Resonant frequency avoidance .....	4-21
Run command selection .....	4-14
Run command direction restriction .....	4-14
running signal .....	4-41
RV .....	5-3
RVR.....	4-40

## S

scaled output frequency monitoring.....	4-15
sensorless vector control.....	4-14
servo-on .....	4-112
SET, SET3.....	4-51
SFT.....	4-36
SF1, SF2, SF3, SF4, SF5, SF6, SF7.....	4-36
SLV .....	4-50
software lock.....	4-59
SPD .....	4-37
Speed limit for torque control.....	4-17
speed/position switching.....	4-37
STA.....	4-37

STP .....	4-58
-----------	------

## T

Temporary frequency addition.....	4-3
test run .....	1-3
thermistor .....	2-21
THM .....	4-40
3-wire input.....	4-14
torque biasing.....	4-17
torque boost .....	4-48
torque control .....	4-17
torque limitation.....	4-28
torque monitoring .....	4-10
troubleshooting.....	5-1
TRQ .....	5-4
TRQ1, TRQ2.....	4-36
2-stage acceleration/deceleration .....	4-36
2CH.....	4-36

## U

UDC .....	4-36
unattended start protection .....	4-36
user monitor .....	4-11
user parameter.....	4-59
USP.....	4-36
UV .....	4-40

## V

vector control with encoder .....	4-14
-----------------------------------	------

## W

WAC.....	4-40
WAF .....	4-40
window comparator .....	4-44

## Z

0Hz detection signal.....	4-41
0Hz speed detection signal .....	4-44
zero-return function .....	4-19
ZS .....	4-41



(memo)

(memo)

# Quick start

**⚠ DANGER** Thoroughly read “Chapter 1 Safety Instructions” and “Chapter 2 Installation and Wiring” in the P1 Basic Manual for installation and wiring of the inverter.

## How to use the VOP keypad

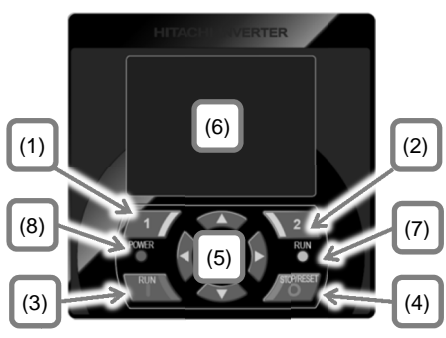

No.	Description
(1)	F1 key Displays the functions in the lower left corner of the screen (e.g. Return to the top page and Cancel).
(2)	F2 key Displays the functions in the lower right corner of the screen (e.g. Data memory).
(3)	RUN key Runs when the key is enabled.
(4)	STOP/RESET key Selects Deceleration stop and Trip reset.
(5)	Selects data on the screen by using the right/left and the up/down arrow keys and confirms the selection by using the O key at the center.
(6)	Display screen
(7)	RUN LED. Turns on when incoming command for operation.
(8)	POWER LED. Turns on when the power is supplied to keypad.

## How to read the display screen (6)

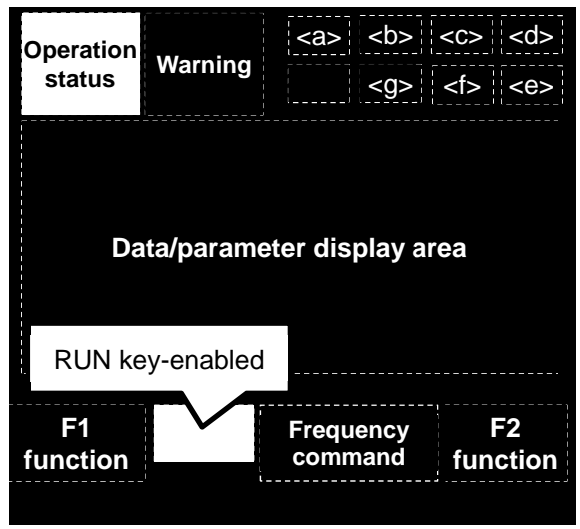

<a>24V supply state, <b> SET function, <c> Parameter display restrictions, <d> Display screen No., <e> Functional safety operation, <f> Command control mode, <g> EzSQ function operation, <h> Special status indication

◇ Part of the keypad screen is shown in below.

## Frequency setting from keypad

**AA101**  
 Main speed source selection  
 No.1  
 01: Input via Ai1 terminal  
 02: Input via Ai2 terminal  
 03: Input via Ai3 terminal  
MENU      SAVE

In case of AA101 = 07 set the frequency from Setting.

**FA-01**  
 Set speed source-M  
 46.49 Hz  
 [0.00-60.00]  
MENU      SAVE

In case of AA101 = 01 set the frequency from the Ai1 terminal.

Analog input/output

Potentiometer for frequency source (1kΩ, 1W or more is recommended)

## Operation setting from keypad

**AA111**  
 Run command source setting No.1  
 00: [FW]/[RV]  
 01: 3-wire  
 02: Keypad  
MENU      SAVE

In case of AA111 = 02 set run/stop from the operator keypad.

In case of AA111 = 00 set run/stop from the FW/RV terminal.

Input

Although there are many functions on the inverter, you do not need to use all the functions. If you need to set functions in more detail, refer to this Basic Guide and User's Guide (You can download from Hitachi Industrial Equipment Systems' Website).