

SN4000. 1/4

NAMUR Interface
Solenoid / Pneumatic Valves

- 5/2, 5/3-1/4
- 30mm Body Width
- Transition Flow 1800ℓ/min (5bar)

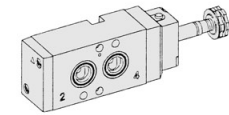

SN4101-IP-
2 4 3 1 5

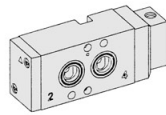

SNP4101
2 4 3 1 5

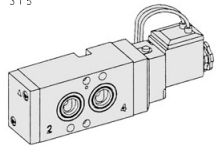

SN4101-IP-SD2-**-
2 4 3 1 5

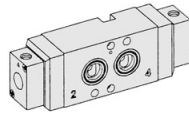

SNP4200
2 4 3 1 5

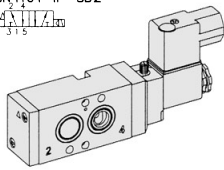

SN4101-IL-SC2-CNM2-**-
2 4 3 1 5

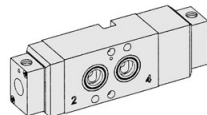

SNP4303
2 4 3 1 5

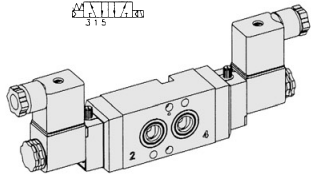

SN4200-IL-SC2-CN2-**-
2 4 3 1 5

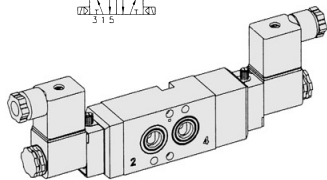

SN4303-IL-SC2-CN2-**-
2 4 3 1 5

** : Voltage Selection (see page 62)

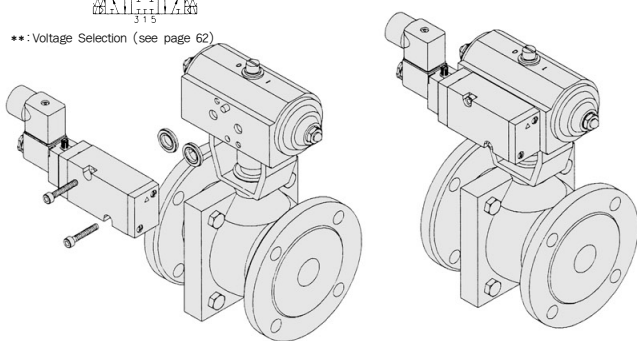

SPECIFICATION

ITEM	SERIES	SOLENOID, PNEUMATIC	
		5 Port 2 Position	5 Port 3 Position
Fluids		Compressed Air & Inert Gases	
Pressure(bar)		1.5~10.0	2.0~10.0
Eff. Sectional Area(mm ²)-5bar		32.0	16.0
Ambient & Fluid Temp.		5~60°C (41~140°F)	
Response Time(5bar)		30ms or Less	40ms or Less
Max. Working Frequency		5c/sec	3c/sec
Lubrication		Not Required(Use ISO VG32 #)	
Manual Override		Push Button(Standard), Lever Lock(Option)	
Coil Insulation Class		F-Class or Equivalent	
Permissible Voltage Variation		±10% of Rated Voltage	
Off Min. Residual Voltage		AC:20% or Less / DC:10% or Less	
Power Consumption		Holding-AC:5.5VA(60Hz) / DC:2.5W	

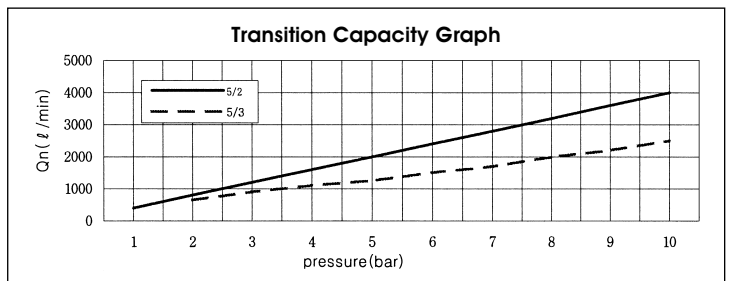

- ### The Material of Parts
- Valve Body : Die-Cast Aluminium
 - Spool : Aluminium
 - Seals : NBR
 - Spring : Stainless
 - Cap : Zinc Pressure Die-Cast
 - Pilot Parts : Glass Filled Nylon
 - Armature : Stainless Steel
 - Armature Seals : Viton

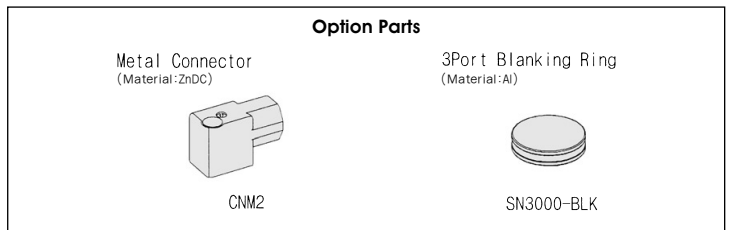

* The specification on each item can be amended without any prenotice to improve a performance.
* The specification on each item can be different from actual specification.

ORDERING NO.

SN4 1 0 1 - I P - SC2 - CM2 - A2

Valve Series	Function	Port Size & Thread	Return Method	Int/Ext. Pilot	Manual Operator	Solenoid Coil Type	Connector Type	Voltage
SN4: Solenoid Valve	1 5/2 Single	0 G 1/4	0 None	1 Internal Pilot	0 None	0 None	0 None	0 None
	2 5/2 Double	1 NPT 1/4	1 Air + Spring		P Push	SC2 3 Pin Connector Coil	CN2 Normal Connector	A2 AC 220V
	3 5/3 Closed Center		2 Air		Non-Locking	SG2 Grommet/Flying Leads	CD2 Connector With LED	A1 AC 110V
	4 5/3 Open Center		3 Spring		L Lever Locking	SD2 Grommet/Flying Leads With LED	CZ2 Connector With LED & Surge Suppressor	A4 AC 24V
SNP4: Pneumatic Valve	5 5/3 Pressure Center						CNM2 Metal Connector	D4 DC 24V
							CDM2 Metal Connector With LED	D2 DC 12V
							CZM2 Metal Connector With LED & Surge Suppressor	

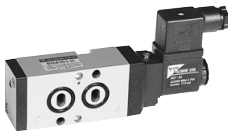
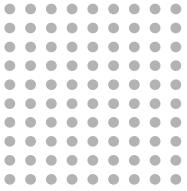

**Namur
Port Thread 1/4**

Solenoid & Pilot Actuated Spool Valves

5Port 2Position Solenoid Valve

Single Solenoid
SN4101-IL-SD2-**-**

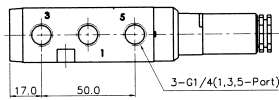
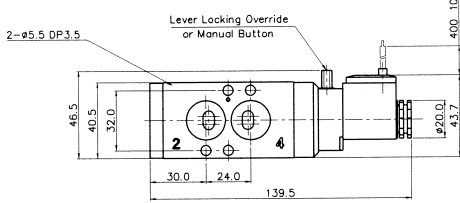
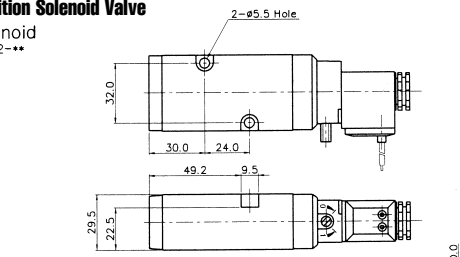

SN4101-IL-SC2-CNM2-**-**

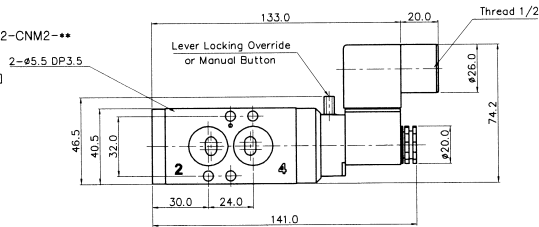

Double Solenoid
SN4200-IL-SC2-CNM2-**-**

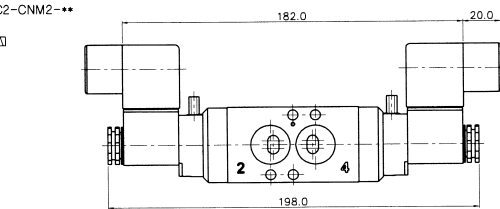

5Port 3Position Solenoid Valve

Closed Center

SN4303-IL-SC2-CNM2-**-**

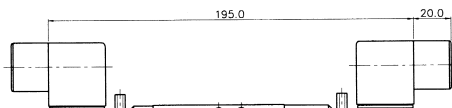
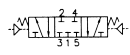

Exhaust Center

SN4403-IL-SC2-CNM2-**-**

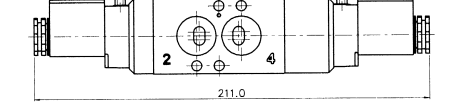

Pressure Center

SN4503-IL-SC2-CNM2-**-**



Sealing Part Dimension

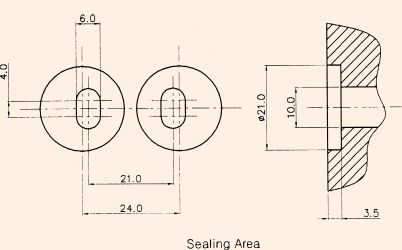

3-Port Blanking Ring Option (Material : Al)

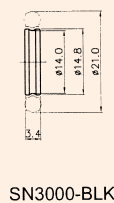

SN3000-BLK

Metal Connector (Material : Zn-Dc)

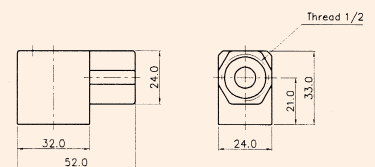

CNM2

5Port 2Position Pneumatic Valve

Single Pneumatic
SNP4101

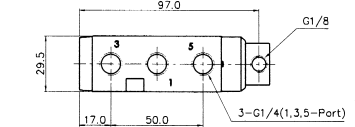
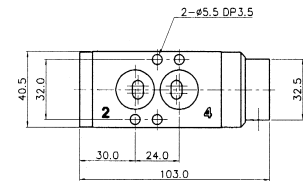
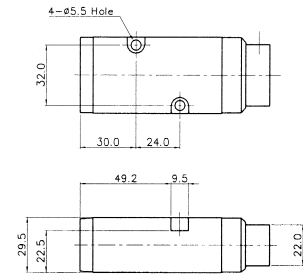

Double Pneumatic
SNP4200

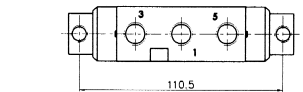
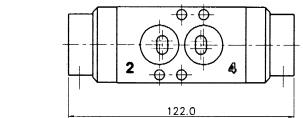

5Port 3Position Pneumatic Valve

Closed Center

SNP4303

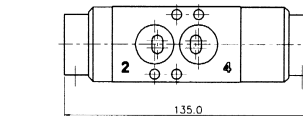

Exhaust Center

SNP4403

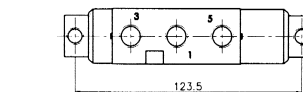
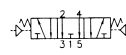

Pressure Center

SNP4503

